

First Copy

SPM 3/30/61

(16)

APRIL 1961
40 CENTS

DXing HORIZONS

"Translator Operators must realize the VHF
Translator is only an interim device . . ."



*Ike Blonder—BLONDER-TONGUE LABS
"Western Translator Conference"
Salt Lake City—March 3*

DEVOTED ENTIRELY TO RADIO AND TELEVISION DX RECEPTION

See Conference Report
Page 6

HORIZONS PUBLICATIONS

MODESTO, CALIFORNIA



Dick Moulthrop (left) and Al Polach (right) from MOULTHROP AND HUNTER, San Francisco, check in for a visit at 1016 - 14th Street, Modesto, March 16.

GROWING... GROWING... GROWING!

Now... **THREE HORIZONS' PUBLICATIONS** reaching and catering to previously unavailable segments of the Electronics Industry!

★ **TELEVISION HORIZONS**

Community Cable Television — Translator Television — Television Reception Engineers and Technicians — Broadcasting Executives and Engineers — Deep Fringe Retail Buyers — Semi and Deep Fringe Wholesalers and Servicing Personnel — TV Experimenters

★ **COMMUNICATION HORIZONS**

Civil Defense Radio — Two-way VHF-UHF Industrial Radio — County, City, Police Communications Systems — MCC Radio — Microwave Point-to-Point — Telephone Two-way Mobile

★ **DXing HORIZONS**

Citizens Band Radio — Shortwave Radio Listening — Shortwave Radio Broadcasting (Commercial and Government) — Medium Wave Radio Listening

Write for attractive brochures describing the SUCCESS PROVEN Horizons Publications' approach to "Electronics specialty publications" today.

HORIZONS PUBLICATIONS

P. O. Box 3206 • Modesto, California, U.S.A.

"YOUR BEST NEWS SOURCE—YOUR BEST MARKETING MEDIUM" in 1961!

Channel

1

News, Exclusive Reports and Marketing Tips to Fringe Area Television Enthusiasts

UHF... LIKE SPRING... IS BUSTING OUT ALL OVER!

Tickled "spring pink" is our reaction. UHF it appears, will get the boot so long overdue during 1961.

Official word has been received from Benco Ltd. of Toronto, Canada, advising that company will soon be shipping Model T-11 and T-12 UHF Translators. T-11 denotes output on channels 14-83, input channels 7-13. T-12 covers channels 14 to 83, with input range of channels 2-6. Benco advises the UHF units will deliver 3.5 watts of output power (peak visual). Units track (turn off and on automatically with origination station) or can be turned off manually by remote control. Each unit arrives in a weatherproof housing, presumably similar to Benco's T-1 VHF unit. Both T-11 and T-12 received DOT type acceptance in Canada February 27.

Unofficial word indicates a 30 watt amplifier will be added to the line shortly.

GEM TO INTRODUCE 50 WATT UHF UNIT ... Under \$3,000.00

Following the very successful showing of the GEM VHF unit in Salt Lake City, GEM President Gene Roelle advised Horizons Publications his firm is completing prototype work on a 50 watt UHF Translator line.

Roelle told Publisher Bob Cooper "we feel that we will be able to offer a complete UHF Translator package for under \$3,000.00, with 50 watt output." Roelle pointed out the difference between a 100 watt unit and a 50 watt unit, is 3 db, or in terms of microvolt reading at a distant receiver, 50 uV versus 37.5 uV. Roelle also stated "we will be using a brand new ceramic type tube which will run with higher efficiency and less cooling than other units now on the market." UHF Translators will be shipped complete with the radio control unit GEM developed for their VHF Translator. First shipment is expected in 90 days.

UHF ON CHANNEL BOOSTER

... "Around \$550.00"

Manufacturer who wishes to go unnamed will announce a complete UHF ON CHANNEL BOOSTER package within 60 days. Unit will consist of low power transmitter, receiver, power supplies and 24 element vertically polarized colinear antenna... and sell for "around \$550.00."

Manufacturer told Horizons Publications five Translator groups have already placed orders for "more than 50 units."

24 element antenna will provide 12 db gain and "squirr signal" over three mile signal path with 1,000-1,500 uV out to a minimum of three miles over flat terrain.

Manufacturer reports he is obtaining "suitable and surprising isolation by going to vertical polarization on the transmitting antenna.

RF portion of the unit will contain six tubes, six stages.

ALL CHANNEL SETS

... Closer—Ever Closer

In one of his last official duties as Chairman of the FCC, ex-chairman Frederick W. Ford told a Senate Interstate Commerce Committee "the Commission will very shortly propose to Congress a bill banning from interstate shipment any television receiver not capable of receiving channels 2-83." Ford noted "most manufacturers have not voluntarily production lined all-channel receivers and the evidence is that they won't unless something of this sort is done."

RCA WINS CONTRACT FOR NEW YORK

UHF GIANT

... To Start Tests August 1

The FCC announced March 1 the Radio Corporation of America has been awarded the prime contract for providing and installing the one million watt UHF channel 30 transmitter to be used during the FCC sponsored NYC propagation study tests.

In the test top-notch industry teams of engineers and technicians will plot the coverage of the channel 30 signal versus that of existing VHF transmitters.

In its final stages, the test results will be analyzed and reduced to a simple formula... "will UHF work as well as VHF within a 20 mile radius of the transmitter?" New York City's manmade caverns and tall buildings are the "unknown factors in the equation."

The contract with RCA calls for the installation to be completed by August 1, followed by two months of transmitter adjustments and antenna loading tests before the actual test program gets underway October 1. The test will run until June 30, 1962 with an option for renewal available.

PUSH FOR STATE TRANSLATOR TAX LAWS

... Oregon, California, Montana Head the List

State Translator groups are reportedly flooding state legislatures with quantities of written material urging the passage of "Translator Tax Dis-

(Continued on page 39)

DXing HORIZONS

APRIL 1961
Volume 2, Number 4

Published monthly in Modesto, California, U.S.A., circulated in 50 states, and 74 countries, to long range-weak signal DX enthusiasts, and operators of TV distribution and rebroadcast systems. DXing Horizons is the official news publication of the World Wide DX League, an international organization of DX listeners-watchers. DXing Horizons is registered to Robert B. Cooper, Jr., 1961.

EDITORIAL OFFICES
DXing HORIZONS
P. O. Box 3150
Modesto, California, U.S.A.
Telephone LAmbert 4-7395

STAFF

Publisher-Editor
Robert B. Cooper, Jr.
(Amateur K6EDX)

ASSOCIATE EDITOR

Art Brothers, W6IQJ

Technical Director

Robert D. Grimm, K6RNQ

Circulation Department

Carole Buchanan, Manager
Jean Lee, Control

Drafting

L. C. Lang

Promotion

Stan Searle

CONTRIBUTING EDITORS

Translator Topics

James Beamer, Secretary
Tri State TV Repeater Assn.

UHF Horizons

Harlow Speckhart, President
National Assn. Low Power
Television Broadcasters

Shortwave

Kenneth R. Boord

Medium Wave

Glen Kippel, WOWPO

English SW Horizons

A. R. "Al" Niblack

Propagation

Stanley Leinwill

Eastern Testing Laboratory (TV)

James Gould
1952 W. Madison
Kokomo, Indiana

SUBSCRIPTION RATES

U.S.A., Canada, Possessions

One Year \$ 4.00
Two Years 7.00
Three Years 10.00

Airmail — One Year 7.00

Foreign Rates

One Year 4.00
Two Years 7.50

In Europe

The Shin Jieh Company
135, Harrowdene Road
Wembley, Middlesex
England
One Year £1.9.0d
Two Years £2.14.0d

In Australia-New Zealand

Colin Burgess
Channel Highway
Taroona, Tasmania
Australia

WEAK SIGNAL TELEVISION

Page

CAPSULE NEWS—TO DEADLINE

“Channel 1” 1

THE FUTURE OF UHF

“What the FCC Has Been Told About UHF” . . . 3

SALT LAKE CITY AFFAIR

“Conference Report” 6

CABLE TV

“Maintaining Line Levels—SKL” 8

“First Canadian Microwave Grant” 10

VHF TRANSLATORS

“Translator Topics” 12

UHF TRANSLATORS

“Site Selection”—Part Two 16

TV DX RECEPTION

“For DXers Only” 24

“The DX Enthusiast” 25

FRINGE AREA BOX SCORE 40

SHORTWAVE-MEDIUM WAVE DX

THE WORLD OF DX 27

SHORTWAVE PROFILE

“Ab Saylor, Virginia” 28

MEDIUM WAVE DXing HORIZONS 29

ENGLISH LANGUAGE HORIZONS 30

SHORTWAVE DX—OPERATING NEWS

“At Fade-Out” 31

“Radio Swan” 31

BCB DX

“South Africa—Ultimate DX”—Part Two . . . 35

DXing Horizons is indexed in “The Electronic Guide.”

POSTMASTER: Executive Office; 1016 - 14th Street, Modesto, Calif.
Second class postage paid, Modesto, California. Send form 3579 to
DXing HORIZONS, Post Office Box 3150, Modesto, California.

State of The Art

Exclusive Report . . .

WHAT THE FCC HAS BEEN TOLD ABOUT UHF

(Part One)

As reported elsewhere^o in this issue, the Federal Communications Commission is moving towards an August 1 target date for commencement of experimental telecasts from atop the Empire State Building, New York City.

The nature of the telecasts will be experimental. The power will be one million watts ERP, the equipment will be of the latest design and highest efficiency.

On UHF Channel 30 (566-572 mc.) the engineering division of the FCC will conduct transmitting and receiving tests over the New York City metropolitan area (see January issue, *DXing Horizons*) for a one year period. Through systematic measurements and recording of field data observed, the coverage of the one million watt signal will be plotted. From this recorded data will come a decision which will ultimately affect every person connected in any way, shape or form with the television industry. *UHF? . . . or VHF?*

NOISE FIGURE

Few will dispute that noise figures inherent within today's crystal mixer tuners and converters is the prime factor holding back further development of UHF fringe area reception. At best the noise figure exceeds 10.5 db on Channel 14 and at the very best exceeds 12.5 db on Channel 83. Any unit but the optimum jacks the noise figure up to astronomical values of 17-22 db in various portions of the UHF band.

Recognizing this fact, the FCC felt it must know what the future held in store. *What major break throughs are to be expected in the tuner and converter field at UHF-TV frequencies?* Is there now a laboratory device which could, conceivably, bring the front end noise figure down to 5-7 db, or even lower?

And, asked the FCC, *"what is the very best commercial unit we can use in our New York City UHF testing program."*

These questions and a few more, were answered for the FCC by Messrs. *J. C. Greene* and *F. G. Haneman*, of the *Airborne Instru-*

^oSee "Channel 1"—page 1.



ments Laboratory, Deer Park, Long Island, New York.

These answers are contained in a 38 page report (illustrated) which was presented to the Commission early in September, 1960. This report, *Horizons Publications* believes, gives considerable direction to Commission thinking—*past, present and future*. It forms the nucleus for *our report* in this issue, and those to follow in "*Television Horizons*," May and June, 1961.

QUOTING

From the introduction to the contract report, "Federal Communications Commission Contract RC-9794 requires a preliminary survey to determine the receiving technique that (1) is deemed most favorable for use in an experimental TV receiver to be used in the New York City UHF test in fiscal year 1962 and (2) shows most promise of providing the best UHF-TV service to the mass market in early 1963. During this study, the following topics are to be considered:

A. RECEIVING TECHNIQUES

1. Direct Conversion Systems
2. Tube RF amplifiers
3. Tunnel diodes as mixers and amplifiers
4. Parametric amplifiers (both beam and semi-conductor types)

B. CHARACTERISTICS

1. Sensitivity and noise factor
2. Input and output impedances
3. Gain

4. Undesired responses
5. Radiation
6. Selectivity
7. Stability
8. Cost
9. Maintenance
10. Convenience in operation."

From this multiple listing, it should be quickly apparent that AIL planned to leave few stones unturned as they attacked the question of what will and will not make an acceptable UHF receiving device for both the NYC UHF test and the years ahead.

Similarly, the Commission hoped it would receive sufficient data from the completed survey to allow it to make a decision, as a joint body, as to *where* UHF is headed.

MORE "QUOTES"

"A. DIRECT CONVERSION SYSTEMS

1. Crystal Mixers

At present, the front-end most widely used in both military and commercial receivers in the frequency band allocated for UHF-TV use is the conventional crystal mixer. This device ordinarily consists of a tunable preselector, the mixer assembly (containing either a single crystal, or a pair of crystals connected in a balancing arrangement), and a local oscillator. The effects of each of these components will first be discussed and some experimental performance data for typical UHF mixers will then be presented.

"The tunable preselector provides selective reception to desired signals while simultaneously rejecting undesired signals and minimizing the local-oscillator power fed to the antenna terminals. However, the presence of a preselector can degrade the overall mixer noise figure in two ways: (1) through its pass-band insertion loss, and (2) through the off-band reactance it presents to the mixer RF terminals at the image frequency.

"The pass-band insertion loss is a function of the number of tuned circuits used in the preselector (determined by the required off-band rejection to undesired signals) and the ratio of the loaded to the unloaded bandwidth of these tuned circuits (determined by the required RF pass-band and the quality of the tuned circuits used).

"Assuming that a maximally flat 3-db RF bandwidth of 15 mc. is required for TV reception, a double-tuned preselector will provide a maximum image rejection of 41 db and a maximum local oscillator rejection of 31 db if a conventional intermediate frequency of about 44 megacycles is used. These rejections

can be increased only by using additional tuned circuits in the preselector and/or a higher intermediate frequency.

"Adding an additional stage of preselection to the converter would increase its "tracking complexity" (i.e., tracking three stages through resonance and impedance curves) and increase the insertion loss.

"Raising the IF frequency would also raise the IF noise figure, and require considerable redesign work on "existing receivers."

AD INFINUM

Now we know what a crystal mixer cannot do. The AIL report concludes its analysis of crystal mixers with these comments: "... it is evident that a major improvement in the noise figure of the commercial mixer will come primarily from a reduction in IF noise figure, but that a significant improvement can also be obtained from the optimum use of a better mixer crystal."

The analysis also notes "*The best crystal mixer presently being used in commercial UHF-TV sets consists of a double tuned preselector, a single mixer crystal (1N82) and a 6AF4 local oscillator.* The overall noise figure of this device, which includes an IF noise figure of 4 db, has an average that varies from about 10.5 db at 470 megacycles to about 12 db at 890 mc."

TUNNEL DIODE MIXER

"The tunnel (Esaki) diode has been proposed for use as a low noise mixer with conversion gain.

"The important questions that must be asked about the tunnel diode mixer are: (1) what is the optimum converter noise figure when the mixer is followed by a typical IF amplifier stage, (2) is there a mixer conversion gain under this optimum noise figure condition, and (3) if so, does the converter then have a negative resistance characteristic?

"Additional points of interest include the linear dynamic range of the device and the local oscillator power requirements.

"One pertinent generality can be stated for any tunnel diode—the noise figure of the diode when used as a mixer will always be higher than that of the same diode when used as an amplifier.

"For illustrative purposes consider a representative commercially available tunnel diode, the 1N2939, used as a mixer. Optimum noise-figure performance is obtained when the equivalent RF loading resistance is about 100 ohms, the diode is biased near the peak of the E-I curve and the peak amplitude of the local-

EVALUATION OF RECEIVING TECHNIQUES
SUITABLE FOR UHF-TV RECEPTION

REPORT NO. 8432-1
August 1960
CONTRACT RC-9794

Prepared for

FEDERAL COMMUNICATIONS COMMISSION
WASHINGTON, D.C.

Airborne Instruments Laboratory
A DIVISION OF CUTLER-HAMMER, INC.
DEER PARK, LONG ISLAND, NEW YORK



FCC Contract RC-9794 gave Commission "professional evaluation" of UHF.

oscillator is set about equal to the DC bias voltage (in the case of the 1N2939, about .07 volts). The resulting minimum mixer noise figure is on the order of 8 db and with a bandwidth of 15 mc., a conversion gain approaching 10 db can be maintained across the UHF-TV band. Under these operating conditions, the tunnel diode presents a negative resistance at both the RF and IF terminals, which is very undesirable if stable and reliable operation is to be obtained.

"This negative resistance problem can be cured in either of two ways. Both result in a degraded noise figure. First, by simply adding resistive loading at the IF terminal, the IF resistance can be made positive. *But*, the effective IF noise figure will go up. However, even this is not too important because of the high mixer conversion gain. *But there is still a negative resistance at the RF terminals.* This will result in signal reflection and critical performance even for small variations in the antenna impedance.

"The only practical solution is to add a non-optimum resistance at both the RF and IF terminals, as a loading device. This will however reduce the conversion gain to 3 db or so and the noise figure of the mixer proper will be degraded, resulting in an overall converter noise figure that is about 12 db (4 db higher than optimum value."

Again, we have found out *what AIL says* a tunnel diode will not do. In their concluding remarks on the subject of the tunnel diode AIL remarks "*because the dynamic range and noise-figure properties of present tunnel diode mixers, the use of the TD is not recommended at this time. It is not likely that such devices will become useful within the near future.*"

THE FUTURE . . .

Skipping over AIL comments on the junction-diode parametric amplifier, the parametric beam tube tunnel diode amplifier, vacuum-tube amplifier and the transistor amplifier (all of which will be covered in May and June subsequent issues), AIL reports they contacted three major television receiver manufacturers for *diverse* opinions on the future "state of the art" of UHF receiving set designs. Company A replied "*Crystal mixers will be used in almost all UHF-TV sets in 1962.*" Company B noted "*In 1962 the crystal mixer will be the device used in most, if not all, UHF-TV sets.*" Company C reported, "*In 1962 the crystal mixer will be the device used in UHF-TV sets.*"

Each of the manufacturers gave their views on the status of 1965 receivers, which will be detailed in the June concluding portion of this series.

-R.B.C.

FLASH . . .

BOOSTER DEADLINE EXTENDED!

In its general meeting of March 22 the seven man Commission moved back the April 1 deadline to file form 346 in the VHF Translator service. Under the time extension, Translator operators NOW HAVE until June 1, 1961 to file completed form 346's, applying for a construction permit for VHF Boosters operating under "special temporary authority." This applies to operators who have filed form 347-only. NEW VHF Translator applicants MUST file form 346 (application for a construction permit) before beginning construction.

CENTRAL CALIF. MADE ALL UHF!

By order, the FCC has made Bakersfield and the San Joaquin Valley in California all UHF. The Commission had previously moved channel 12 Fresno to channel 30.

In ordering the move of existing KERO-TV channel 10 Bakersfield to channel 23, the FCC ordered a hearing on the modification of the KERO license to specify operation on channel 23 instead of channel 10.

KLYD-17 and KBAK-29 already operate on UHF in Bakersfield.

We ALL Learned a Lot . . .

SALT LAKE CITY — '61

Translator Conference

Translator enthusiasts from 24 states and Canada flocked to the snow bound city by the Salt Lake over the March 3-5 weekend for the first DXing Horizons' "Western Translator Conference." By nose count, more than 250 interested soles wound their way through exhibit sections "E" and "F" of the underground Conference area at the Hotel Utah Motor Lodge, giving the eight Translator manufacturers on hand more than a casual once over.

Translator enthusiasts in attendance represented all of the states west of the Mississippi with the exceptions of Nebraska, Oklahoma, Missouri, Arkansas and Louisiana. UHF Translator notee *J. R. Karban of Rhinelander, Wisconsin* surprised the throng by checking in Friday A.M. along with more than forty other individuals who did not pre-register.

Each manufacturer naturally thought his equipment was the hit of the show. And from

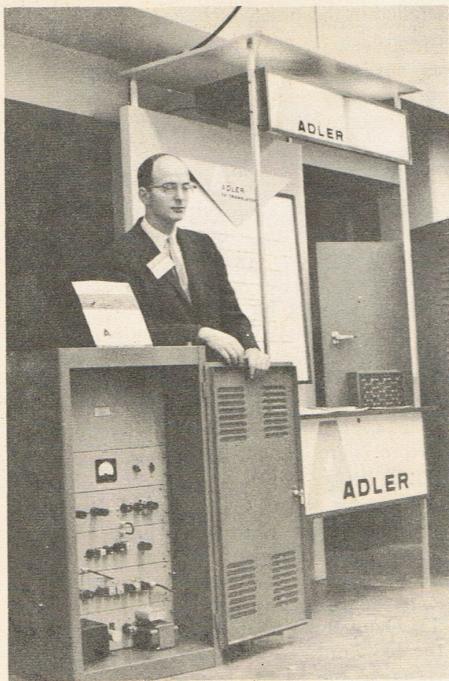

ADLER ELECTRONICS' traveling goodwill ambassador, Director of the Industrial Products Division - *Stan Lapin*. Lapin holds the door open on the new Adler VST-1 VHF Translator . . . a real beaut!



"AND DO YOU KNOW" . . . asks Darwin Hillberry of the Fremont TV Club, Riverton, Wyoming, of DXH Translator Topics Editor Jim Beamer, out of camera shot to the right.

an unbiased standpoint, it must be said that no two looked alike . . . so there may be considerable leeway for comparison, even if only on a basis of superficial appearance!

The Adler Electronics VHF unit on display (see photo below) drew considerable attention from Translator enthusiasts familiar with the Adler UHF unit.

More than thirty broadcasters on hand representing forty-four stations gave particular attention to "technical ability to deliver a broadcast quality signal" and the "expected life" of the units.

Also on the receiving end of a long line of interested Conference delegates were the people from EMCEE. Dr. Byron W. St. Clair

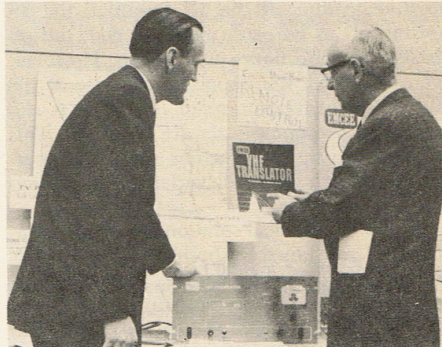

Dr. B. W. St. Clair (left) listens attentively to National TV Repeater Association President Jesse Slusser of Denver, in front of the EMCEE booth at the Conference.

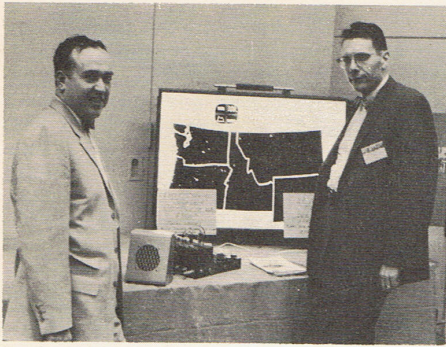

"ONLY 29 MORE DAYS TO FILE" warns Pat Quinn (left) of Video Utility Company, Seattle. Owen "Andy" Anderson (right) "just happened to have a fist full of 346's in his vest pocket!"

led off the Friday afternoon Conference session with a discourse on "Radio Control for Translators." Meanwhile EMCEE Vice President Hank Shapiro kept the model HRV unit running, converting channel 2 Salt Lake (KUTV) to channel 9 for those who cared to watch TV!

Telson Electronics of Rapid City, South Dakota was a late starter at the Conference line. President Elmer Nelson signed up to participate February 23, just hours before the Conference program was printed. Telson's

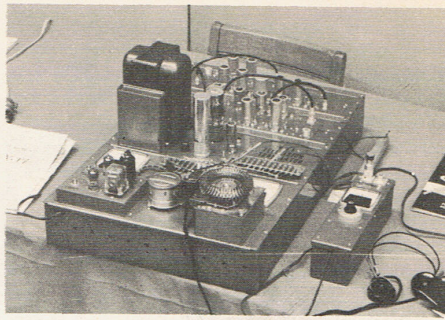

INDUSTRIAL TUBES THROUGHOUT according to the literature being passed about the Conference by Telson Electronics, Rapid City, South Dakota. According to word given Horizons Publications by Elmer Nelson, Telson President, unit now sells for \$1,545.00 complete.

one watt unit (see photo 5) showed the care and patience of a well-qualified broadcast engineer which Nelson is at KOTA in Rapid City.

Blonder Tongue made perhaps the biggest physical showing at the Conference with attending representatives covering all areas in the west. Ike Blonder of B-T and Phil Freen, President of Benco, kept their second story room humming with activity throughout Friday and Saturday as leading Translator delegates filed into talk "weak signal TV" with two of the real pioneers in the field.

The GEM Radio control unit was a keen topic of conversation by those in attendance, (Continued on page 18)



"AND SHOULD IT RAIN TOO HARD, IT FLOATS!" Paul Powers (center) of TV Pix, Inc., Salt Lake City (EMCEE distributor) stands before the TV PIX all fiberglass equipment shelter, weather tight and very practical. The shelter was a big interest of the show and is now available through TV Pix at 179 Social Hall Ave., Salt Lake City 11, Utah.



BUSY PLACE! General Electronic Mfg. booth "agin the fer wall" at the Conference drew considerable interest from Conference goers anxious to learn more about Radio Remote Control.

CABLE

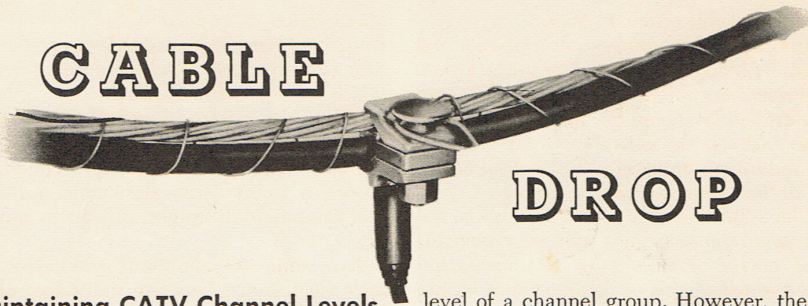

DROP

Maintaining CATV Channel Levels Under Varying Conditions

By
W. J. ALBERSHEIM, Vice President, Engineering,
Spencer-Kennedy Labs, Boston, Massachusetts

Part 1. AUTOMATIC LEVEL AND SLOPE CONTROL IN WIDE BAND CATV SYSTEMS

The group of TV channels distributed by wide band CATV systems is carried from high tower "head end" pickup point to the individual home TV receivers over a complex transmission system that may contain 20 miles of cable with about 80 db per mile attenuation. (See Chart 1.) In addition, there are considerable losses for branching connections and equalizers. This staggering total of over a thousand db is made up by as many as 50 amplifiers in cascade.

As shown on Chart 1, the attenuation of high frequency coaxial cables increases over 10% from winter to summer temperatures, and several per cent from night to day. The gain of amplifier tubes may also drop 10% over their useful life. Hence, the total system gain may fluctuate literally hundreds of db—yet the customer must get his TV signal constant to within 10 db. To add further complexity, every amplifier has a well-defined operating range. When the input level is too low, the picture suffers from "snow" (noise) and poor synchronization. When the output is overloaded, the different channels interfere, causing cross modulation, "windshield wiper" effect and herringbone patterns.

Hence, a delicate level balance must be maintained throughout the passage of signals on the system. SKL achieves this balance by pilot-operated *automatic level control* (ALC) stations, spaced at intervals of from three to five amplifier points.

Why pilot operated? Some operators feel that it should be sufficient to control the level of one typical TV channel, or the average

level of a channel group. However, the effective level of each station fluctuates with the character of its picture; furthermore, each channel is subject to station failure and sign-off. Automatic substitute channel carrier generators for each air channel are expensive. Experience has shown that a very good compromise is maintained by injecting a constant pilot signal in an unused channel in the upper part of the frequency band. In systems using only the low VHF channels and subchannels, the preferred pilot frequency is 74.25 mc.; in wide band VHF systems, 182.25 mc. is frequently used.

The pilot level is below that of the picture carriers so that its effect on amplifier loading is reduced. It is picked out by a narrow band-pass filter, selectively amplified and rectified. The negative DC output of the rectifier is fed back into the grid bias circuit of the wide band line amplifiers. Thus, the output line level is held to within plus or minus 1 db, even if the input level were to vary 20 db—a condition which is not permitted to occur except in emergencies.

The operation of the automatic level control in a wide band CATV system is illustrated in Figure 2.

At the "Head End" the required number of TV signals is picked off the air or locally generated, separately preamplified and regulated to the desired level. At the same "Head End" location, a local oscillator supplies the pilot carrier signal. All these signals are added in a multichannel combining network such as SKL type 863.

The combined channels are passed through as many forward amplifier stations as can be tolerated without undue cumulative level fluctuations. Even in these intermediate stations, the frequency differential in cable loss must be corrected by equalizers that compensate for the square-root-of-frequency attenuation slope of coaxial cable. There may also be forward acting compensation for the temperature variation of cable loss, as will be explained

in part two of this article in May.

Between the last intermediate amplifier and the ALC (Automatic Level Control) station, the intervening cable length is reduced so that the controlled line amplifier has ample reserve gain to take up the cumulative variations of cable and tube transmission. The output of this ALC station amplifier passes through a type 491 Pilot Filter unit which lets the bulk of the signal go straight through without noticeable loss of power or change in relative carrier levels. A small sample of this filter unit output feeds a narrow band-pass filter, peaked at the pilot carrier frequency, and passes on to the type 830 Pilot Carrier Control Unit. This control unit first amplifies the pilot carrier to a level of the order of 10 volts, rectifies it with negative polarity and passes the rectified output through a low pass filter of suitable time constant. This output is then impressed upon the grid bias of the line amplifier (type 211 or 222) and thereby produces negative envelope feedback with a high envelope loop gain. This provides a very stiff gain control with an operating input range of over 20 db and a level compression ratio of about 20:1.

A more detailed study of Chart 1 indicates that the cable loss for any given distance is

about twice as high at the upper end of the frequency band (Channel 13) as at the lower end (Channel 2). Moreover, this differential loss increases with temperature.

While the average loss differential can be taken care of by fixed "slope equalizers," the variable component (due to temperature) produces a cumulative slope change that, unless compensated, might add up to hundreds of db.

In systems of great length and narrow tolerance on balance between individual channel levels, SKL has provided *Automatic Slope Control* (ASC). This control system utilizes two separate pilot carrier frequencies, located near the upper and lower end of the frequency range.

The entire frequency band containing all TV channels and both pilot carriers, passes through the Pilot Operated Equalizer (SKL Model 474). This contains a differential amplifier, the gain slope of which can be varied by means of grid bias. The output of this amplifier passes through a wide band amplifier (SKL Model 211) and then Pilot Equalizer Filter Unit, SKL Model 489. The filter unit lets the bulk of the output pass down the line without distortion and with little loss.

Two other filter outputs provide small, narrow band, samples of the two pilot carriers. The high frequency pilot carrier output passes to a control unit (SKL Model 830) where it is

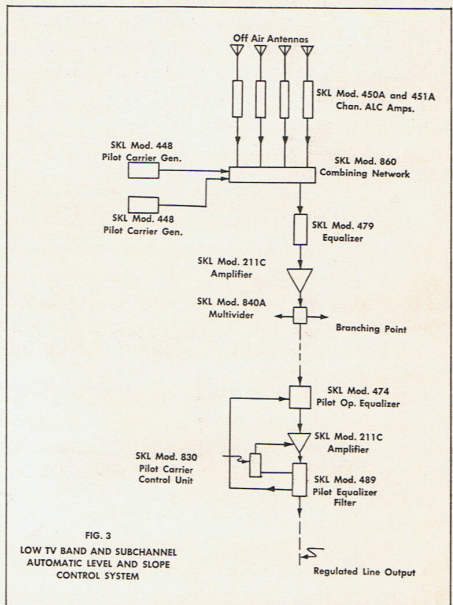
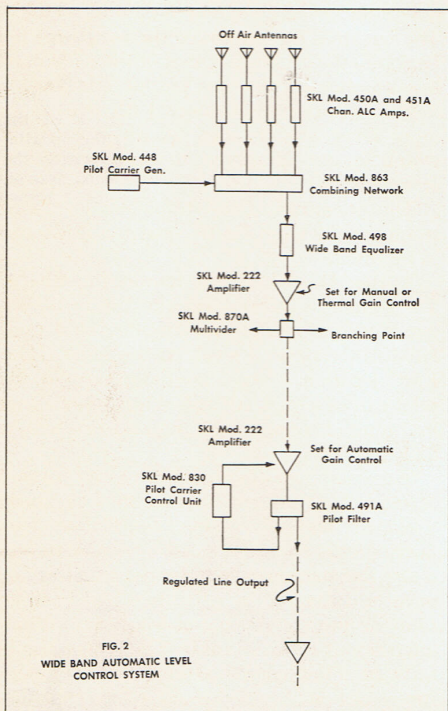

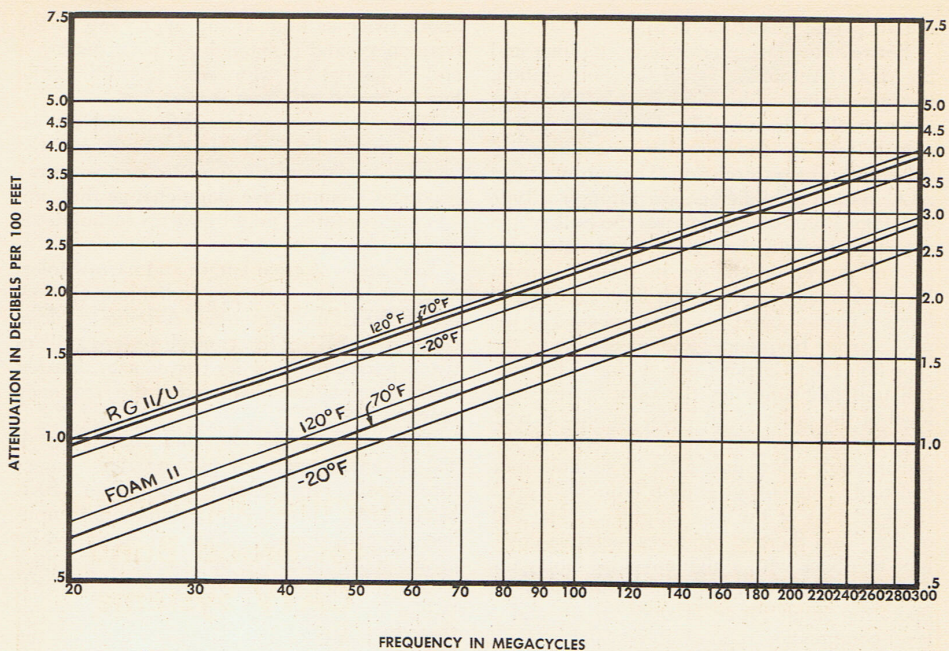

amplified and rectified and serves to control the output level of the 211 Amplifier in the manner described above. The low frequency pilot carrier output is returned to a second control unit built into the 474 Equalizer where it is amplified, rectified and impressed upon the grid bias of the differential amplifier.

This produces a stiff slope control with an operating slope range of about 10 db and a slope compression of about 20:1.

In May, "Thermal Regulation of Gain and Slope."

FIRST CANADIAN CATV MICROWAVE GRANTED...

GAGON TV LTEE 5 HOP SYSTEM

In the north of "inhabited Quebec" Monsieur Lucien Leclerc is awaiting the melting of the winter snows as he plans and replans the installation procedure which will put into operation the first Canadian Cable TV Microwave feed system. The installation involves 5 hops (see map) across
(Continued on page 22)

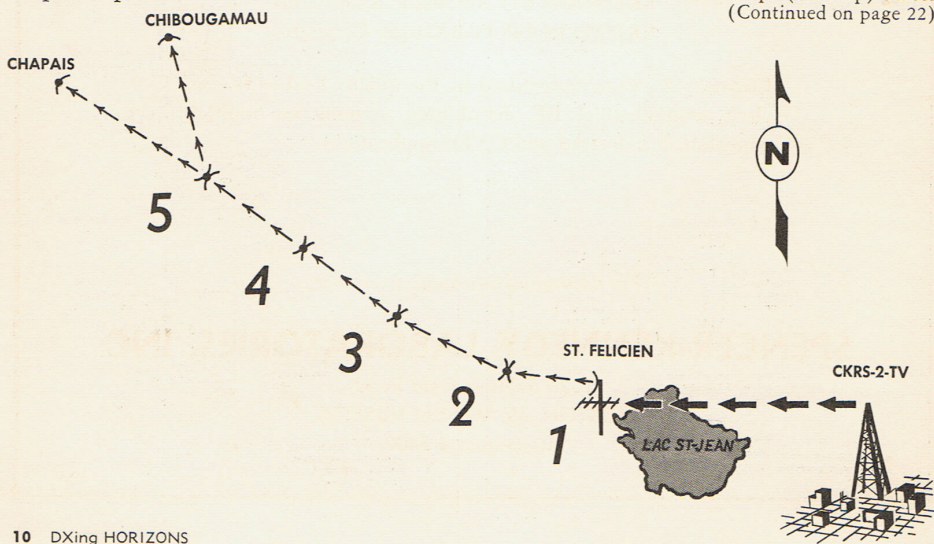

Simplicity and Stability

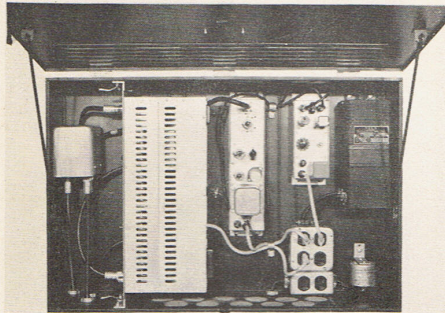

TYPICAL ALC STATION Arrangement
With Automatic Alarm Unit



Automatic Level Control Equipment for Broad Band CATV Systems

Less than 2 db change in output level for a 20 db change in input level in ANY system with the use of proven equipment!

SKL Model 211C or 222 TV Amplifier
SKL Model 830 Pilot ALC
SKL Model 491A Pilot Filter
SKL Model 831 Automatic Alarm Unit
SKL Model 448 Pilot Carrier Generator

Engineered and manufactured by the quality leaders in complete multi-channel RF distribution systems for military, educational, industrial and CATV applications.

For additional information contact:

SPENCER-KENNEDY LABORATORIES, INC.

1320 Soldiers Field Road
BOSTON 35, MASSACHUSETTS
ALgonquin 4-5400

TRANSLATOR

Prepared monthly by
James Beamer*
P. O. Box 833
Livingston, Montana

TOPICS

SALT LAKE CITY

... All Present and Accounted For

Your editor wishes to heap up a big vote of thanks to all Translator operators who made the journey to Salt Lake City. Certainly the meeting was very well attended and did more to give direction to the VHF Translator operators than others held to date. A special vote should go out to FCC men Harold Kelly and Allen Cordon who took the time to straighten out many misunderstandings we operators have been belaboring under.

ARSON SUSPECTED IN TRANSLATOR BURNING

... Sprinkler System in Order?

An experimental UHF Translator operating on Mt. Antoine west of Zortman, Montana burned beyond recognition February 28. Sheriff Dove of Phillips County told *Horizons Publications* "all clues point toward the crime of arson." Dove noted that all equipment had automatic cut-off and accepted safety features to prevent electrical wiring shorts which might develop into fire. The UHF unit was housed in an air-tight structure, "making it practically impossible to get a fire started." Sheriff Dove noted that indications were the fire was a very hot one, everything inflammable burned to ashes and the electronics equipment was reduced to a molten mass.

The lock and catch on the door of the building also showed signs of having been forced.

Sheriff Dove continued "on the day of the fire a two-wheel-drive vehicle drove up the mountain-side towards the Translator site, but was unable to negotiate the entire distance. Evidence in the snow showed tracks of two people walking the remainder of the distance to the Translator shack."

Sheriff Dove has conferred with the County DA in Malta and all agree arson can be blamed for the blaze.

The UHF unit (ADLER) was installed by LeRoy Abel of Shelby, Montana, a field representative for Pat Quinn's Video Utility Company. The station was operating under the VU experimental-developmental license KO2XFN.

Unofficial comments following the fire indicated there has been some bitterness over the proposed UHF unit from other television constituents in the area.

ABOUT NEWSPAPER ADVERTISING

... Part C, Appendix, Modified

Following Senator McGee's Casper, Wyoming hearing in late February (see March DXH, page 38) Commissioner Robert E. Lee, who was in attendance, carried the ball back to Washington seek-

**Secretary, National TV Repeater Association, Tri-State Repeater Association.*



NTRA PREXY Jesse Slusser (left) and your editor in Salt City March 3.

ing a modification of paragraph C in the Appendix of the rules governing Translator operations. Paragraph C concerned the question of "notifying local residents within the area to be served that a Translator license had been applied for."

Commissioner Lee reportedly drew three top legal aids at the commission into his quarters and sought an explanation of "why Translator operators should be required to spend large sums to advertise their intents." The outcome of the sessions appears below:

"By order the Commission amended section 1.359 of the rules relating to the giving of local notice of applications for broadcast facilities and amendments thereof to exempt TV translator stations from requirements of subsection (c) and adding a new subsection (d) . . ."

Broken down, the rules pertaining to "public notification" are as follows:

(1) The notice must be posted (i.e., post office, public meeting place, etc.) or published within two weeks of the date you sent your form 346 (or modification thereto) to the FCC.

(2) It must be published in a local, weekly or daily newspaper, if such paper is published within the area covered by your (Translator) broadcast.

(3) If no newspaper is published within your broadcast area, a notice may be posted in the post office or general meeting place at a central point within your broadcast area.

(4) Within 5 days of the time you publish or post this public notice three copies of a statement must be sent to the FCC in Washington (in care of Ben F. Waple, Acting Secretary, FCC, Washington 25, D.C.). All copies of the statement must have a notarized signature.

We suggest this wording for the statement which will accompany the actual public notice (i.e., tear sheet from the newspaper, carbon copies of posted sheet from the newspaper, carbon copies of posted

(Continued on page 19)

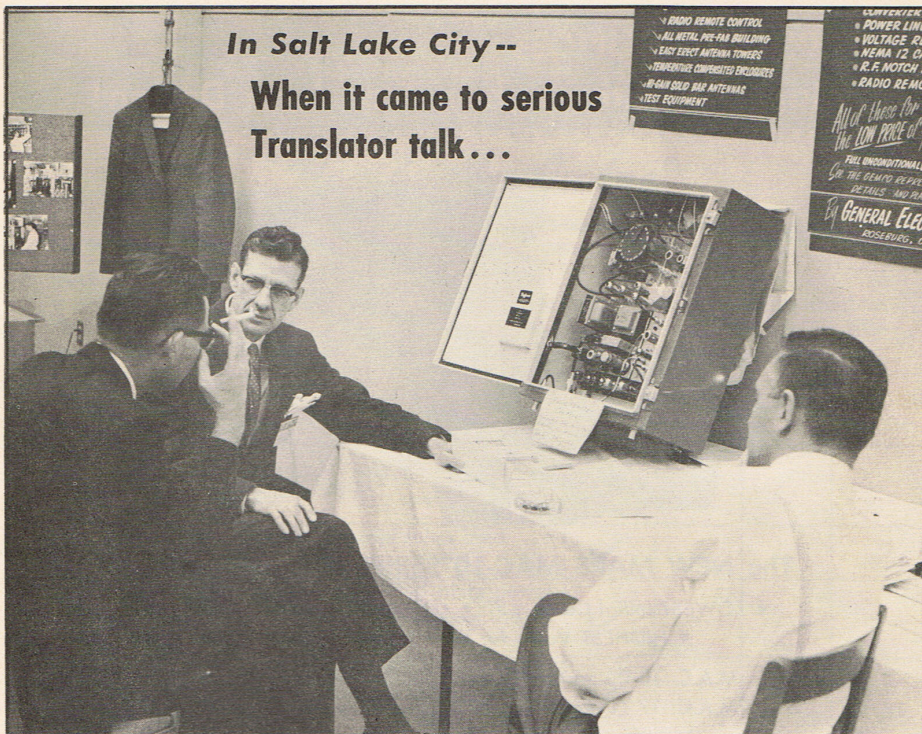

**In Salt Lake City--
When it came to serious
Translator talk...**

GEM STOLE THE SHOW!

**GEM Offers the Only Complete Translator Package including
Radio Remote Control — One, Two or Three Channels!**

- ★ **RADIO REMOTE VHF TRANSLATOR** — single channel **\$1,095.00**
- ★ **GEM—FIRST** with two and three channel systems . . . all with radio remote control! Don't spend duplicate amounts to install two, three or more separate VHF units when you can do it with GEM for much less cost and twice the reliability!
- ★ **COMPLETE TWO CHANNEL TRANSLATOR** — with radio remote control — **\$1,845.00!**
- ★ **COMPLETE THREE CHANNEL TRANSLATOR**—with radio remote control—**\$2,595.00!**

All Radio Control units are fail safe, activated by specially designed mechanical reeds calibrated to a tenth of a cycle. No need to worry about interfering signals here!

Complete unit includes these "usual extras" as **standard equipment.**

LINE FILTER NOTCH FILTER OUTPUT METER
VOLTAGE REGULATOR **RADIO REMOTE CONTROL** ATTRACTIVE INDOORS CABINET

YOUR GEM-1 VHF TRANSLATOR IS FULLY GUARANTEED
Satisfaction or your money back!

GENERAL ELECTRONIC MANUFACTURING, INC. (GEM)
POST OFFICE BOX 865 • ROSEBURG, OREGON

GEM, Inc.—From the Land Where People Know Translators Best . . . The Pacific Northwest

MARS ANNOUNCES ... Major Breakthrough in Translator Design!

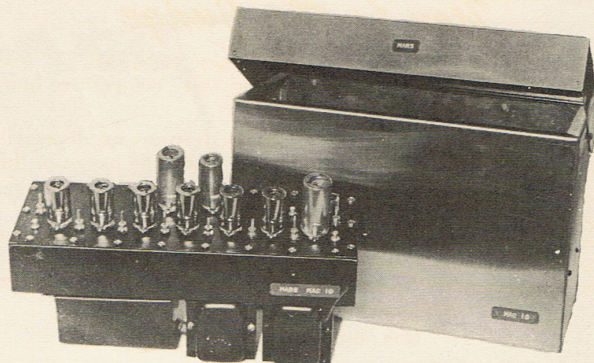

The NEW MARS MAC-10 SERIES VHF Translator

- **LOWEST Initial Cost!**
- **LOWEST Maintenance Costs!**
- **HIGHEST Value for Your Translator Dollar!**

M.A.C. 10 (1/3 watt)—List \$666.50—Dealer Net \$500.00

M.A.C. 17 (1 watt)—List \$933.00—Dealer Net \$700.00

**FULL TWO YEAR WARRANTY — ALL PARTS AND SERVICE!
MONEY BACK GUARANTEE — COMPLETE SATISFACTION**

*MARS—Since 1954, continuously leading in VHF Translator research and design
from the heart of North America!*

- Optical Code Identifier—no contact points to corrode or arc.
- Stainless steel — temperature controlled — vibration cushioned housing.
- All tubes industrial types—premium quality, operating far below ratings.
- MARS ultra stable overtone conversion oscillator eliminates troublesome multiplier stages.
- Designed for tower mountings, eliminating feed line losses and increasing *effective* radiated power (more ERP for your dollars!).
- Dual rectifier—choke filtered power supply, runs cool and functions normally **EVEN** if one rectifier fails!
- All stages turn off plate power when the input signal leaves the air, resulting in up to **FIVE TIMES MORE TUBE LIFE!**
and yet
- Three to five minutes of **DELAY** on automatic shut-off eliminating "clatter" normally associated with signal fades!
- Dual Conversion where required, with MARS trained help in selecting the optimum IF for each conversion.

PLACE YOUR ORDER FOR THE NEW MARS MAC SERIES VHF TRANSLATOR NOW!
(Off the Shelf Delivery May 1, 1961)

Also available for export to Canada, Mexico, M.A.C.-39 (5 watts)—meets Canadian D.O.T. standards. Available in international Conversions and power frequencies.

MID AMERICA RELAY SYSTEMS, INC.
601 Main Street
Rapid City, South Dakota

WIN A NEW MAC-10 FOR YOUR TOWN

in the

MARS TRANSLATOR EVALUATION CONTEST!

"You be the Judge"

From your own first hand knowledge, check these eight "MUST" features in the NEW MARS MAC-10 series Translator against *any three* competitive brands.

RULES

The following is a list of important Translator features for dependable trouble-free quality signals. In the three columns provided, enter the names of three Translators (other than MARS) which you are familiar with and check the squares indicating your knowledge of each unit.

In case of a tie, the winner will be determined by the best suggestion under number 9 below. The decision of the judges will be final.

Manufacturer's Name: Unit name/number:	M.A.R.S. MAC Series			
1. Conservatively operated <i>industrial tubes</i> used throughout.	✓			
2. "Miracle" Automatic Control cuts <i>off</i> plate power to <i>all</i> stages when broadcast station leaves the air (to conserve unit component life).	✓			
3. TWO YEAR PARTS AND SERVICE WARRANTY, unconditional "satisfaction or money back" guarantee.	✓			
4. FACTORY TO YOU SALES. <i>One</i> nationally advertised price of \$933.00 (one watt) and \$666.50 (one-third watt).	✓			
5. Factory engineered for tower mounting to eliminate high "cable loss." Features instant removal from vibration cushioned housing (with temperature control for housing optional).	✓			
6. OPTICAL IDENTIFIER with no arcing "relay" contact points. Variable delay to five minutes, eliminates "clatter."	✓			
7. All tube mounted on conventional bases in vertical position eliminating inter-element shorts, increasing tube life.	✓			
8. No "dual function stages" such as common use of single power supply, or amplification followed by attenuation.	✓			
9. In 25 words or less, enter here a "new feature" you consider desirable for VHF Translators.				
.....				
.....				
Enter your name.....				
Address.....				
Mail before Midnight May 1 to MID AMERICA RELAY SYSTEMS, INC. 601 MAIN STREET • RAPID CITY, SOUTH DAKOTA				

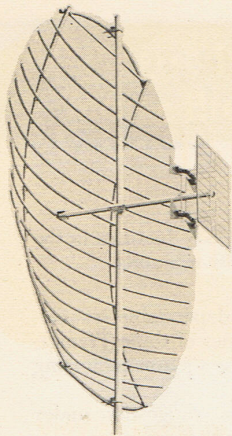

UHF HORIZONS

"News of the UHF Translator World"

Conducted Monthly by
Harlow Speckhart*
Route 1, Box 317
La Grande, Oregon

VHF-UHF TRANSLATORS ... Picking a Translator Site (Part Two)

In the March column we discussed the various reasons for taking extra care in selecting antenna sites for the Translator station. These included maintaining proper input signal levels, covering a substantial portion of the local population so as to make the operation a plausible one from a finance standpoint, ad infinitum.

TRACKING THE SIGNAL

If you were to take a portable field strength meter into the cockpit of an airplane, connect up a suitable antenna and begin signal measurements near the TV broadcast transmitter, you would find a nearly constant although gradually decreasing signal level as the plane moved away from the broadcasting antenna. Even free space has loss! Pure air, so to speak, is not a perfect conductor of electromagnetic waves. It does in fact absorb part of the transmitted energy as the wave passes through it. The amount of absorption changes with air temperature, and the air's moisture content. Based upon this substantiated fact, the National Bureau of Standards has issued a map of the United States which shows the amount of "attenuation" you can expect in various portions of the country, in free space. This map is contoured to correlate "free space loss" into terrain areas. From this map the casual observer will quickly see the southeastern portion of the United States is one of the more favorable spots for VHF-UHF wave propagation. The same map also indicates that most areas of the Rocky Mountain states show high free space loss figures, dependent upon the time of year (i.e., average air moisture content and air temperature).

Recognizing that free space does have some loss, the astute observer will be quick to point out that daily or weekly changes in "regional" weather

conditions (i.e., hot and dry to cool and foggy, etc.) are reflected in varying "free space" signal levels.

Thus even the Translator operator who boasts his path is "line of sight" to the TV transmitter must recognize that his average signal levels will vary from day to day.

Generally speaking the "free space path" user can expect his median signal to vary 2.5 to 5 db from summer to winter. In mountainous regions the median signal will average higher in the winter, while in the flatter regions, the summertime signals will average highest.

CHANGING CHARACTERISTICS

One occasionally hears a Translator operator remark, "Our received signal has deteriorated—it was good when we put the system in, but now it is way down." Your editor queried Engineer George Frese about such a possibility and Frese remarked, "To my knowledge I have never known a site to change its characteristics."

The change that has occurred is most likely due to deteriorating equipment. One solution to this problem is as follows: When the receiving antenna installation is under construction, erect a simple cut to channel dipole mounting it securely to the antenna tower. Over a period of days, while the remainder of the equipment is being installed, measure and record the off-air signal level from the dipole.

When the large receiving array is erected, take a set of comparison readings to establish a signal ratio between the dipole and main arrays. From this ratio, plotted carefully over a period of days, the Translator operator will obtain a ready reference for future comparison. Whenever you suspect your signal level is "down" on the big array, measure the dipole signal and analyze your signal ratio. If it is not "up to par" you can begin trouble shooting the big array and its multiple connections and intricate phasing sections.

Deterioration of the antenna (large intricate arrays) is slow and builds up over a period of time as corrosion sets in on the elements, connections, etc. Thus the antenna "site" often gets the blame for the gradually receding signal level, which in truth can be directly traced to the "antenna."

INDIVIDUAL CHARACTERISTICS

Each site has its own set of characteristics. The very nature of the surrounding terrain materially affects the value of each site. If you locate your antenna at the top of a hill the degree of the slope "downhill" from you and even the vegetation on the hill below you will influence the signal levels. For this reason it is often better to locate the antenna on a "ledge" or plateau on the side of the hill, rather than on top. This characteristic is for the most part traceable to "ground reflections" which appear as either "in phase" or "out of phase" energy at the dipole of the antenna. If "in phase," the ground reflection signal adds from 3 to 6 db overall signal level to that picked up by the direct path of the antenna. If "out of phase" the ground reflection signal subtracts (cancels) part of the original direct path signal and the net result is a 3 to 6 db loss in signal. Often times the difference between an additive ground reflection signal and a "cancellation" ground wave signal is a matter of one-half wavelength movement of the antenna array, left or right, up or down.

THE UHF HOME RECEIVING INSTALLATION

By EDWARD PELISSIER

Before we leave the subject of converters, a word about tuning. When you are fishing for a weak signal, try "rocking" the tuning knob on the converter. The mechanical gearing of converters is such that even the best are not geared down enough to give anything approaching a vernier action in the wide UHF spectrum. For most applications it would be a wasted addition to the unit. However, to find the "most critical point" on the converter where the signal will "peak up," gently rock the tuning knob back and forth searching for the best signal. Usually the knob need barely move to find the spot where the signal will "pop up" out of the noise.

Don't forget the fine tuning on the set. With the converter ahead of the set, it becomes a means of "aligning the IF" to the UHF signal. And, check both channels 5 and 6 (and reset the converter tuning knob when you change IF channels) as one channel may produce a better picture on your set than the other. This is due to factory tuning of the converter, NOT your set.

GROUND THAT MAST!

No mention has been made of lightning arrestors because the author feels that if they must be used in your area, they simply must be used! They are of rather dubious value if lightning actually strikes although they do serve to discharge static electricity, which at UHF tends to disfigure the picture much the same way car ignition does on VHF. This is especially true with antennas of a large aperture area such as the Channel Master Parascop Model 425. Extend a grounding strap from the metal mast to a driven ground rod. To construct an adequate ground rod, simply use a discarded piece of pipe, drilling the pipe with one-quarter inch holes at intervals of two inches (from the estimated ground level to the bottom of the pipe) and drive the pipe into the ground, capping the base end before you drive it. Fill the pipe with ordinary table salt, which provides a moisture reservoir for the grounding system. This will give you the ground you need to keep static electricity at a minimum. Connect your grounding strap to the driven ground rod with a galvanized pipe clamp.

ROTATORS

Finally, if you live in a UHF area with several stations or you are a DXer with UHF leanings, watch out! In my case I discovered one end of my rotator was "dead" (devoid) of signal. The answer was simple enough. As the rotator turned, my transmission line pulled close to (but still not touching) the mast holding the antenna. The situation was remedied by carefully mounting the standoff insulators (six-inch variety) to keep the transmission line at least six inches away from the metal mast at all times. If you have trouble try a standoff insulator mounted on a spring. No, they aren't available at the corner store. Write to Burstein-Applebee Company, 1012 McGee Street, Kansas City 6, Mo. The spring mounted standoff insulator has no part number, so you had best describe what you want.

Follow these guide lines carefully, and an entire new world of weak signal UHF reception awaits you.—E.P.

Your Translator Picture...

will only be as good as your
Transmitting Antenna!

JAMPRO ANTENNA COMPANY offers the
TV Translator industry Transmitting
Antennas specifically designed for
Translator use.

- Full 6mcs. Bandwidth
- VSWR under 1.3 to 1
- High Voltage Gain
 - + to 16.2 db on the High Band
 - + to 11.2 on the Low Band
- Proven Rugged Design
- Field Tested in United States Government Low Power TV Installations
- Directional and omni-directional Patterns Available

JAMPRO offers a complete line of antennas designed strictly for VHF Translator service. All antennas equally suited for off-the-air pickup as well as transmitting.

Don't be caught with your picture quality down and your VSWR UP! Remember—no matter how much you spend for your Translator...

"Your Translator picture will only be as good as your Transmitting antenna array!"

Write for details today, stating your requirements.

JAMPRO

ANTENNA COMPANY

7500 14th AVE. • SACRAMENTO 20, CALIF.
Gladstone 1-4375

TRANSLATOR CONFERENCE

(Continued from page 7)

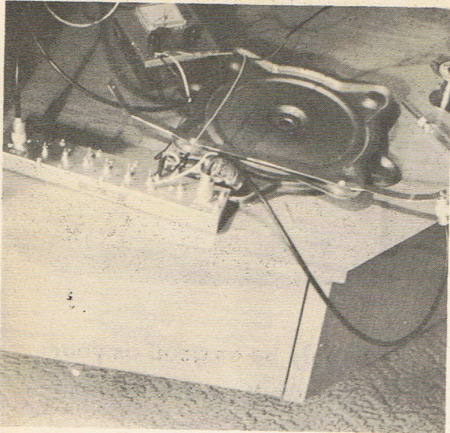

"YOU PROBABLY WON'T BELIEVE THIS" MARS engineer Keith Anderson told us, "But, that is a complete one-third watt Translator." Here Anderson uses the TV set metal stand for his "antenna" (note coax loop on right) and produces the photo on the right.

as they talked over the merits of the line with Gene Roelle and Dick Bennent. GEM's unit showed considerable design experience and President Roelle of the firm promised further units will be added to the line by mid-summer.

The "boys from MARS" arrived in good shape late Wednesday night in the company's



"MY QUESTION TO YOU" began Walt Wagstaff (standing) of KGW-TV, Portland as he addressed Horizons Publisher, Bob Cooper on the stand, "is can you prove there are people in this country today who do not have suitable off the air reception." We referred Wagstaff to *Broadcasting Yearbook* annual, a source he quickly denounced as "two years out of date and highly inaccurate." Question was not resolved.

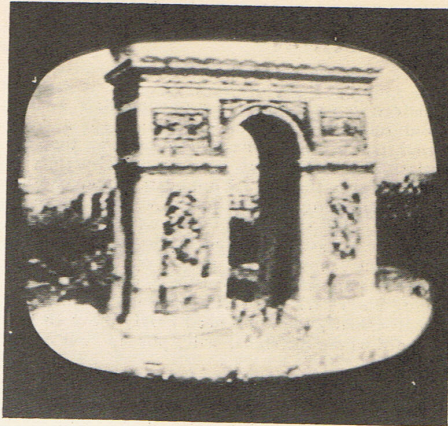

TEN FEET AWAY, PICKED UP ON RABBIT EARS this is the signal the one-third unit produced operating on 18 volts of battery power! Unit will run up to a year without attention or power (other than battery) if properly mounted and protected.

Cessna 180. Along with design engineer Keith Anderson and President Gene Bartlett was our old friend Charlie Starr. Charlie reported the light plane bucked 100 mph headwinds all the way, and even veteran pilot Anderson got a little green behind the ears.

Above all else, we convinced Charlie there would be no point in suing your editor (see story in December *Translator Topics*), and Charlie convinced us we shouldn't try to wrestle any Wyoming rancher for the check (my wrist is still sore!).

The entire crowd assembled Friday evening at 8 P.M. to hear Ike Blonder deliver his keynote address "The Future of Small Town Tele-

(Continued on page 36)



THE MOST POPULAR PAIR IN SALT LAKE, FCC men Harold Kelly (left) and Allen Cordon (right—standing) were scheduled for a one hour session on form 346, Saturday Morning. Session lasted for two and one-half hours!

TRANSLATOR TOPICS

(Continued from page 12)

printed notice).

"We hereby certify that the attached public notice was published in the.....

(name of newspaper)

paper, or posted in the.....

(place where posted)

on the dates of.....

(dates of printing or posting)

to comply with the Commission's rule section 1.359(d)."

Note A—In the event you use a newspaper, we suggest the entire sheet containing the notice be attached for exhibit.

Note B—If a public notice is used, a copy of the notice as it appears together with the date of posting should be used as the exhibit.

ACTUAL NOTICE

Horizons Publications suggests the following form be used when posting or printing your public notice.

"The....., on.....

(name of TV Association) (date)

has filed with the Federal Communications Commission, Washington, D.C., an application to construct a new television translator station to serve the.....

(name of area to be served)

area.

The translator transmitter will be located at..... and will be used for.....

(geographical coordinate)

the purpose of rebroadcasting the signal of television broadcast station.....

(call letters)

broadcasting on channel..... and located at.....

(town station licensed to)

The television translator station will rebroadcast on channel..... with an output of..... watt peak visual power.

Signed:.....
(president or secretary of association)

MONTANA TRANSLATOR LAW

... Signed March 6

Montana became the third state to adopt a Translator Tax District law when a proposed bill moved through the legislature and landed on the Governor's desk. The bill was signed March 6 and is now the law of the land should Montana Translator groups care to make use of it. Utah and Nevada previously had passed Translator tax laws.

ABOUT TRANSLATOR MODIFICATIONS

... FCC Clears the Water

FCC man Harold Kelly was put on the spot in Salt Lake City by several Translator representatives anxious to learn "how they might continue antenna experimentation with their translators." The problem seems to be "once we have filed for our construction permit, or have our license, how do we 'try out' further antenna modifications without filing for a lengthy modification of our CP or license."

FCC man Kelly advised Translator applicants to notify the Commission of intent to "experiment" and to note the type of changes contemplated. Nor-
(Continued on page 36)



EQUIPMENT SHELTER

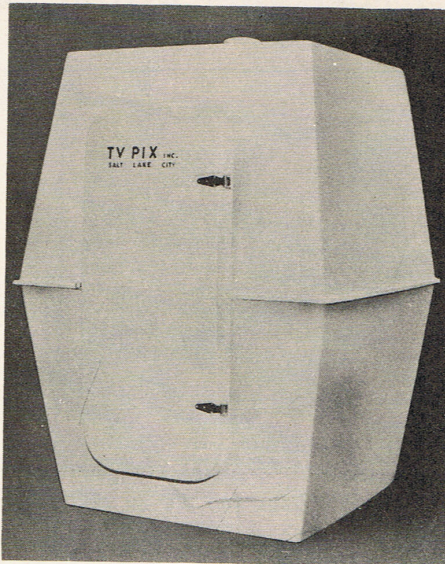

DESCRIPTION	Model 55
Height (Overall)	7'4"
Width (Outside)	5'3"
Depth (Outside)	5'6"
Shipping Weight	350 lbs.
Cubage	212

F.O.B. Salt Lake City

FEATURES...

Double Strength Molded Fiberglass Construction — Built-in Guying-Hoisting Rings — Rustproof, Stainless Steel and Chrome Plated Hardware — Super Strength, all Surfaces Curved — Weather-Tight, Self-Insulating — Long Life, Low Cost, Lightweight — No Upkeep Expense — Designed for 115 mph Winds when Guyed

OPTIONS...

Electrical Wiring — Ventilator and Filter — Thermostatically Controlled Exhaust Fan — Equipment Mounting Shelf

ALSO... EMCEE Translators and Custom Engineering by FCC Licensed Broadcast Engineers

TV PIX Inc.

175 SOCIAL HALL AVENUE
SALT LAKE CITY, UTAH

FCC Type Accepted*... of course!

EMCEE VHF TRANSLATORS

Selected for Custom Design, Easy Installation,

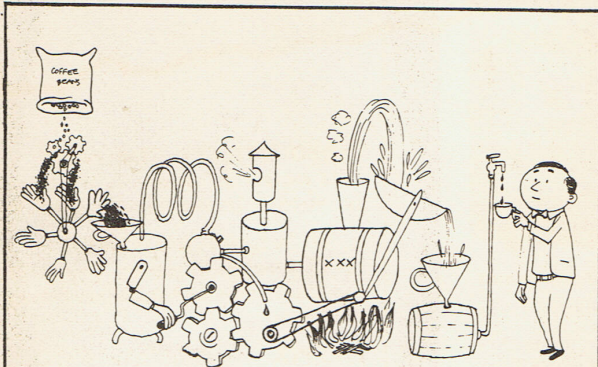

THIS MAY BE A WAY OF MAKING COFFEE... but in our book you are on pretty shaky ground.

You don't have to be a connoisseur of good coffee to realize this is not the way to make a perfect cup. Like in most things the custom designed equipment generally does the job best — be it coffee makers or translators. There are people who concoct translators from sub-assemblies 'borrowed' from other systems — but even though some have earned FCC type acceptance the comparison is between the half-hearted result of a coffee substitute and a full satisfying cup of proper coffee.

EMCEE TRANSLATORS operate at maximum efficiency because EVERY CIRCUIT is specially designed and integrated and every component is specifically engineered and precision made for this particular translator. No "lash-ups"! No forced fits of existing products! Dependability and reliability are actually ENGINEERED into each section so that all parts and circuits work with each other to perfection assuring long years of maintenance-free performance.

TRANSLATORS MAY BE RUN IN TANDEM TOO!

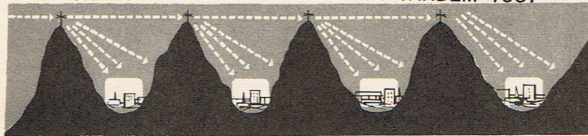

* MODEL HRV FCC TYPE ACCEPTED

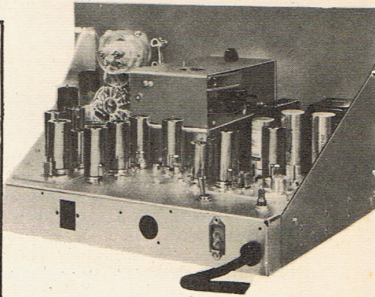

TECHNICAL

Input: Down to 50 Microvolts on A.G.C.: 30 db input variation from 50 microvolts to 50,000 mic

Output: 1 watt with no measurable distortion Mountings available: 8 3/4 rack or

- **CONVERSION FLEXIBILITY**... any input any non-adjacent output channel.
- **FREEDOM FROM INTERFERENCE**... no intermodulation products which coincide with input to translators.
- **Model HRV**
Complete FCC-Type Accepted VHF Translator.
- **Model UHRV**
Same as Model HRV With UHF Input Included.
- **LEGALIZER**
For existing installations... provides 1 watt output... automatic on-off and identification... makes compliance with FCC rules easy. Factory measured electrical characteristics minimize field measurement. Exhibits included with equipment simplify filing FCC forms.

ELECTRONICS, MISSOURI

262 East Third Street

SLATOR

& Top Performance!



DESK CABINET MOUNT

CAL DATA (MODEL HRV)

75 ohm line.

Produces less than 1 db output variation for signals

volts.

Has sync compression; 50 or 75 ohms.

Available in desk cabinet; self-contained outdoor housing available.

Channel to

Internal sig-

any other

- **EASY OPERATION UNDER FCC RULES** . . . simple control and identification unit minimizes maintenance and reduces cost . . . no operator required.
- **EASY-INSTALLATION** . . . available for cabinet/rack mounting or in weatherproof housing.

EMCEE DOUBLE CONVERSION VHF TV TRANSLATOR

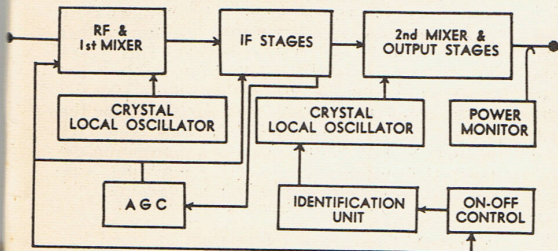

LES AND COMMUNICATIONS, INC.

• Mount Vernon, New York • MO 8-3012

OUR THANKS FOR YOUR
WONDERFUL ACCEPTANCE OF
OUR EQUIPMENT AT THE
SALT LAKE CITY CONFERENCE

If you missed EMCEE out West
contact your nearest distributor
to see EMCEE for yourself.

VIDEO UTILITY COMPANY

2444 Market St., Seattle 7, Washington
and Field Associates throughout Northwest

A. W. WEART BROTHERS

16113 S. Harris, Compton, California
and Distributors and Installers throughout
Southwest

T.V. PIX

Social Hall Ave., Salt Lake City, Utah
and Field Offices in Eastern Nevada and
Southern Idaho and Wyoming

L. B. WALKER RADIO COMPANY

100 N. Victoria Ave., Pueblo, Colorado
537 N. First St., Grand Junction, Colorado

ELECTRONIC DISTRIBUTORS

891 Van Dalia St., St. Paul Minnesota
and Electronic Associate Stores

MIDWEST RADIO SALES

3219 West 117th Street, Cleveland, Ohio
9440 Marlowe, Plymouth, Michigan

K & M ELECTRONICS

Minneapolis, Minnesota



ELECTRONICS, MISSILES AND COMMUNICATIONS, INC.

262 east third street • mount vernon, new york • A

Gentlemen:

— My community needs better television.
Please rush free planning package
including data sheet, complete instal-
lation check list, coverage calculation
form.

— UHF input

— LEGALIZER for existing installations

— Please send free reprint of FCC
rules covering translators.

NAME _____

ADDRESS _____

CITY _____ STATE _____

CABLE DROP

(Continued from page 10)

rugged and mostly uninhabited central Quebec. Fortunately for Mons. Leclerc the microwave path can be located along and next to a semi-paved roadway which he leads from St. Felicien, Quebec (250 miles north of Montreal) to Chapais and Chibougamau, the twin "termination points" of the microwave and the home of Mons. Leclerc's Cable TV Systems. The total path length, from the TV transmitter of CKRS (channel 2) to the termination at Chapais and Chibougamau is 210 "television miles." The first 60 miles are covered by the CKRS-2 TV transmitter to a point at St. Felicien, most of which transverses Lac St-Jean (see map). At St. Felicien the channel 2 signal is converted to a channel in the 1875-1975 megacycle range, which is assigned for point to point microwave in Canada. From that point to the twin termination points a microwave station repeater is situated every 28 miles. Each station consists of a Marconi type DQ58 microwave installation, a 250 foot tower and a pair of six foot dishes.

The microwave path covers 150 miles through five relay points. A power splitter will be used at microwave station number five to feed signal to both Chibougamau and Chapais. Both towns are literally "at the end of the road" as one goes north in Quebec.

The grant to Gagon TV Ltee. is unusual for several reasons. First of all, it is the first PRIVATE microwave grant ever made by the BBG (Canadian version of FCC). Secondly, it is the first Canadian Cable TV microwave grant.

Thirdly the Canadian government has been even more interested in Canadian CATV operations of late than the U.S. government has been in American CATV operations. They have been particularly cautious over any sweeping statements which might indicate that CATV has a place in the Canadian allocations program.

However the BBG has been quick to realize that ALL Canadian residents deserve television, the people of Chibougamau and Chapais not excepted. The total number of sets which may eventually be served in the two towns is possibly 1,000. It is therefore obvious that even a satellite television station is not economically feasible for direct coverage of the area.

Mons. Leclerc notes, "As soon as my network from St. Felicien to Chibougamau is completed, I have plans to construct another one in order to give two supplementary channels to my subscribers in about one year. I shall have in 1962 about 2,000 subscribers on my CATV systems in four different towns."

It is also interesting to note that CKRS-2-TV, which will feed the system, is actually a satellite itself operating off of CKRC-12-TV in Jonquiere, Quebec. Thus the picture (French Language) which finally finds itself on the screen of TV viewers in Chapais and Chibougamau, Quebec, this summer will have traveled from channel 12 to channel 2 and through five microwave relay hops, before it is finally viewed by the "far north Canadians."

With the ice broken for other Canadian CATV operators, it will be interesting to watch as others file for "microwave permits" from the BBG.

PACIFIC NORTHWEST CATV CONCLAVE

... Seattle — April 17-18

Columbia TV Service General Manager Kirk Kirkeeng of Kennewick, Washington reminds CATV operators in Washington, Idaho, Oregon and Montana of the Annual get-together to be held at the Olympic Hotel, Seattle over the period April 17 and 18.

All CATV operators in the four state area, as well as adjacent regions, are urged to attend if for no other reason than to take pop shots at Horizons Publications' Editor Bob Cooper!

Cooper is scheduled to address the April 18 (Tuesday) luncheon meeting and he promises to keep the subject "meaty and controversial" (in keeping with his reporting style apparently!).

William Dalton, new President of the National Community Television Association, will be on hand from Washington, D.C., to greet first hand Association members.

Monday the 17th will be a day of general business meetings while Tuesday will be devoted to technical and management sessions.

COX CONFIRMED TO HEAD BROADCAST BUREAU

... Friend of Foe?

At the reported urging of new FCC Chairman Newton Minow, Seattle Attorney Kenneth Cox was appointed to head the FCC Broadcast Bureau, a post effective April 10.

Cox was thrown into the CATV and Communications' limelight in January 1959 when as a special counsel to a Senate Commerce Committee he stated the FCC should have regulatory control over "all devices, including CATV and Translators-Boosters, which enter in ANY way into the allocations scheme of the Commission.

His report to the Senate committee on small town TV noted that the CATV operator was a parody on the allocations scene and that he "favored a single locally produced signal to several signals piped into town from big cities."

As new Broadcast Bureau chief, it will be interesting to watch his influence on pending CATV legislation.

NATIONAL CATV CONVENTION

... San Francisco — June 20-23

Ten years of organized Cable TV will signify a "milestone meeting" in the city by the Golden Gate June 20-23 as the nation's CATV operators gather for the annual NCTA Convention. This year's event is to be held in the world famous Jack Tar Hotel, with a post-convention "jet tour to Hawaii" promised for those who care to partake in the fun making. NCTA Special Assistant Frank Nowaczek has been named to coordinate the Convention doings and he reports he is actively soliciting "suggestions" to aid him in Convention planning.

NCTA NEWS

... New Director of Information

... New Headquarters

Leonard H. Lieberman was named Director of Information for the NCTA February 27, according to an announcement from William Dalton, NCTA head. Lieberman has more than 20 years of Public Relations work and has held several key posts with Federal agencies.

On March 6, the NCTA headquarters moved to "535 Transport Building, Washington 6, D.C."

**Allen's Winona "TV Signal Co."
... Likes "Horizons"**

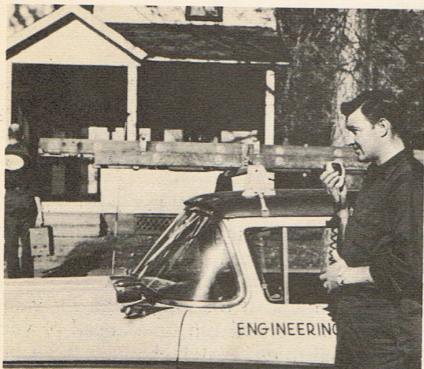

Two-way radio (photo above) speeds immediate service to CATV customers on the Winona, Minnesota TV Cable company captioned by the very able Ed Allen.

In a recent letter to "Horizons Publications" Allen noted "On behalf of our company, may I say that *we enjoy* your fine magazine and appreciate your efforts on behalf of the CATV industry."

We thank you Mr. Allen... and incidentally, "*we enjoy* your letters!"

resulting in "more leg and work room" for the entire staff.

H & B EXPANDING

... Future of CATV "Bright"

Leland B. Hallett of Wenatchee, Washington has been appointed Area Supervisor in the Pacific Northwest for H & B American Corporation, holder of the ex-Jerrold Company CATV franchises throughout the country. Hallett will be responsible for managing the CATV properties through the subsidiary TRANSCONTINENT COMMUNICATION SYSTEMS according to David E. Bright, Chairman of the Board at H & B.

H & B operates the CATV operations in Wenatchee, Walla Walla and Richland, Washington.

H & B also recently announced acquisition of CATV systems in Prescott, Arizona and Missoula and Whitefish, Montana. A common carrier microwave system goes with the Montana purchases. With these purchases TSC now enjoys the distinction of being the largest single CATV entity in the field, with more than 41,000 subscribers on 12 wired systems.

Leon N. Papernow, ex-Jerrold CATV whiz, heads up the TSC CATV operation.

AMECO EXPANSION

... Whitney at the Helm

Edward P. Whitney, new AMECO National Sales Manager (Phoenix, Arizona) has announced the appointment of Richard F. Yearsick of Lewistown, Pennsylvania as Eastern Regional Sales Manager for AMECO, the manufacturing division of Antennavision, Inc.

Whitney assumed his duties as AMECO sales manager March 1, after leaving the post of Executive Director at the NCTA, Washington, D.C.

Yearick comes to AMECO from TELCO of Lewistown, Pa. where he served as General Sales Manager. Yearick was formerly Office Manager for Pennwire Television Company, a CATV system in Lewistown.

Whitney told Horizons Publications further immediate expansion of the AMECO sales force is under way with plans to cover the entire nation with AMECO CATV products moving ahead smoothly.

KBAK GOES TO BRECKENRIDGE

... Better Coverage

KBAK-29-TV moved from its San Joaquin Valley floor location to 7,000 foot plus Mt. Breckenridge east-northeast of Bakersfield February 29, at the same time increasing power to 117 kw. At the outset of the KBAK transmitting schedule was composed of transmitting hours from both transmitter locations while adjustments were made to the new antenna array. By this time full operation should be underway from Mt. Breckenridge.

TRADE 'N SWAP

SELL—Three Blonder Tongue MLA amplifiers. Two in excellent condition, \$40.00 each; third needs new filter condenser (we supply) \$30.00; one MAGC unit—\$25.00. All units less tubes for ease of shipment. Prepaid to you upon receipt of check. Newcastle TV Ass'n., Inc., Box 331, Newcastle, Wyoming.

Save \$\$ on your house drops!

Try the PRUZAN easy 2-in-1 way using

.091 Galvanized Lashing Wire

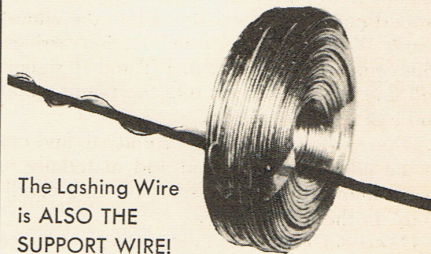

The Lashing Wire
is ALSO THE
SUPPORT WIRE!

SPECIAL \$1.00 PER COIL

Packed 6 Coils
325 Feet (7 lbs.) per Coil

Freight prepaid on orders of 24 or more!

JACK PRUZAN COMPANY

1963 1st AVENUE S.
SEATTLE 4, WASHINGTON

For DXers Only

(TV and FM long distance reception reports from DXing Horizons readers. The editors welcome reports from readers interested in reporting their long range observations to this desk. Reports to appear in the May issue of TELEVISION HORIZONS must be in Modesto not later than April 12.)

MIDWEST AIRBORNE IN THE AIR

The MPATI test program has been running "air checks" of transmission patterns at press time. Long range TV enthusiasts throughout the midwest are advised to keep a sharp eye out for signals on channels 72 and 76 during the "daytime hours" in the next several weeks.

Your antenna heading will be Montpelier, Indiana and the antenna tower is 21,000 feet high! The DC-6B carrying the UHF transmitters will be circling in a slow pattern at this height while the transmitters crank out the kilowatts.

Horizons Publications urges TV observers noting signs of these "airborne-signals" to keep this desk advised of reception conditions. Any reception point within a 400 mile radius of Montpelier, Indiana equipped with a deep fringe UHF setup should be well within range!

Another interesting possibility during the month of May also enters the special tests as far as DX TV fans are concerned. Flying at 21,000 feet, the DC6B is apt to find itself "within a tropospheric duct" of phenomenal proportions during late May when the almost yearly "Great Lakes Trops" session arrives. This could mean the Channel 72 and 76 signals will find their way west into the plains states and east to the seaboard.

DXers will have the opportunity to find out in the next six weeks, and add materially to man's knowledge of unusual "ducting conditions" in the UHF range.

DXers set your sites . . . now is the chance to pioneer in some real UHF TV DX reception!

PARASCOPES GOING UP!

Strong evidence of serious minded DX in the UHF range continues to be reported by DX enthusiasts throughout the country. Seven DX fans reported to Horizons Publications this month new Channel Master Parascope antennas (see July 1960 DXH for full report) have been installed during the "winter DX lull." We expect some really unusual UHF reports this summer and will not be too surprised to

see a Great Lakes DXer logging the high power UHF transmitter from New York City (channel 30) as reported elsewhere in this issue.

SPORADIC E SKIP

. . . 'Tis the season to beware!

As March turns into April, TV DX fans the country over are overhauling rotors, stringing new feedlines and cleaning up antenna contact points. The reason is seasonal and the cure is unknown!

This is the season for TV DX reception like no other DX reception. Suddenly on the low band TV signals from stations 700 to 1500 miles away appear as if by magic.

If you are new at the long range TV game then you have a real fun time ahead of you! Here is what to do. Watch channels 2-3-4 between the hours of 4 P.M. and 9 P.M. local time from now until May 1. If you live in the midwest, watch to the south and east. Be especially aware of sudden venetian blind interference indicating two or more stations. During April signals are apt to be "weak" and spotty, although the strength and frequency of appearance will increase as April wears into May.

After May 1 channels 2-6 are all fair game and DX is liable to show up at any hour from 7 A.M. to 9 P.M. local time. The hours of 7-9 A.M., noon to 2 P.M. and 4-8 P.M. will continue to be most productive.

Eastern DXers (Pennsylvania east and south to Virginia) watch to your south and southwest. Western DXers (west of the Rockies) keep a keen eye out to the southeast and north. And Rocky mountain DX enthusiasts should watch to the northeast, southeast and southwest.

EASTERN LAB TOWER

. . . Down one again!

Horizons Publications (for the unaware) conducts extensive propagation studies through a pair of "off-the-air" reception labs. Our Eastern Lab is located in Kokomo, Indiana, managed by Jim Gould. Our western lab is located northwest of Modesto and is under the auspices of Publisher Cooper.

In July of last summer Engineer Gould's entire antenna array came smashing down 70 feet to the hardpan soil of central Indiana. Nothing was salvaged and the entire array was replaced.

In February the entire NEW array met a similar fate and stacked Trans-Coupler yagis, a beautiful UHF Parascope and various side

(Continued on page 26)

The DX Enthusiast

By
Gordon E. Simkin
Idaho Falls, Idaho

In February and March George and his young TV DX enthusiast pal Jim discussed the evaluation of a TV receiver for DXing purposes. With the summer time DX season coming on so quickly, the topic changes slightly to one of identifying stations seen.)

"Hey George" I clearly saw K-I-N-G on the screen, isn't that station in Seattle" burst out Jim as he ran from the back of George's TV service shop, where he had been testing various receivers.

"Well" began the old DXing pro, "K-I-N-G TV is in Seattle, but I doubt that was what you just saw."

"But I'm sure those were the letters on the screen" insisted the youth.

George said nothing, smiling a bit he took out a copy of his new JONES RADIO-TV STATION LOG and referred to the channel 5 list of stations. "See what channel KING-TV is on Jim" he inquired.

"Oh, its on channel 5. But I saw the letters on channel 4. How come?"

George smiled again. "This time I can answer your question because I was watching channel 4 here in the front of the shop on another set. What you saw out of the corner of your eye, as you switched channels, was a pack of cigarettes!"

The lad sighed . . . "Oh!"

George continued. "Jim this is one of my strongest pet peeves in TV DXing. Many people would have logged that station without further thought. And had they bothered to check to see if they were on the right channel, they would have rationalized the entire matter by reporting it as *off-channel reception*."

"Supposing," George went on, "the advertisement for KING cigarettes had actually been on channel 5, and not channel 4. And you saw just a snatch of it, as you switched channels, as you just did. What then?"

"I would probably have logged it as KING in Seattle" admitted Jim sheepishly.

"But" George raised his voice a few db, "No one can be truly honest with himself and claim a positive station identification on such a short burst. Even the TV stations can be held at fault in many cases. I have seen the network

operators on the west coast fall asleep at the switch and allow the WCBS New York and WFIL Philadelphia ID call slides to come through over the air here in the west. Sure the program began in New York, or Philadelphia, but it wasn't broadcast from there when I saw it! It came from a Los Angeles transmitter. Now in the case of WCBS, the CBS station in Los Angeles is on channel 2, just like WCBS. If I saw this on skip, what is to keep me from thinking I have logged New York, instead of Los Angeles. And many times, especially on educational TV broadcasts, the call letters of the station that put the program together is included in the credits. What is to keep me from saying I have logged WQED in Pittsburg when I see it on channel 2 on skip from WAIQ in Andalusia, Alabama? Sure the channel is wrong! But . . ."

George sat back in his chair and waited for the impact of his oration to work in.

Jim slid his feet across the floor, kicked a 6J6 under the bench and finally admitted "Guess I'm responsible for some improper loggings then."

But George wasn't finished. "And while I am griping a bit Jim I want to mention my second *pet peeve*."

Jim nodded his head and George went on.

"I sometimes wonder about a DXer who tries for a particular station, to increase his totals. Now this is OK if proper precautions are taken. When you are receiving a weak signal its possible for almost any bit of garbled speech to sound like the call letters you are waiting to hear! And even good clear pictures, or brief bursts of clear picture, can be read to say exactly what you want them to say. Oh I'm not saying the DXer does it on purpose. What I mean is that he can be so wrapped up in his DXing that he lets his sub-conscious get the better of him.

And even photos of the TV screen don't always solve this problem."

(Next month George shows Jim some photos of TV DX that had your editor looking twice!)

THE LAW IS FOR THEM THAT BELIEVE

... Part Two

The March DXing Horizons detailed an unusual application from the Washington Post Company (holder of license for WTOP) which sought a pair of UHF Translators and a single VHF unit, in a line, from Denton, Maryland to Rehoboth Beach, Delaware. Recently filed with the Commission were modifications of the original application, specifying "more exact" Translator locations and channel changes. The final link in the U-U-V circuit is a channel 9 VHF unit at Rehoboth Beach with an (amended) ERP of 8.85 watts.

FOR DXERS ONLY

(Continued from page 24)

mounted antennas plummeted 65 feet to the snowpacked Indiana soil.

In July it was a wind storm. In February it was an ice storm. *Suddenly we like California* and its rather complete lack of ice-snow and unduly heavy winds. Now (crossing our fingers) if we don't have any earthquakes all will be well.

P.S.—The eastern lab antenna is now being replaced... watch for a picture of the revised array.

DX PREDICTIONS

TV long range enthusiasts will keep a wary eye out for meteor scatter (meteor showers promised), tropics (springtime Gulf area tropics promised) and E skip during the next 6 weeks.

April 1-30—*Gulf Coast region*—Slow moving high pressure areas meandering north from the Gulf of Mexico promise to provide a bangup session of 500-1000 mile ground wave. Watch for signs of normally received fringe stations "dropping their snow" as your first clue conditions are improving.

April 10-30—*E SKIP*—Southern and western DXers will note this form of DX reception first as it appears around (predicted) April 15, 21 and 25-30. Watch channels 2-6, 4 P.M. to 8 P.M. LST.

April 21—*METEOR SHOWER*—Excellent annual *Lyrids* shower producing substantial burst reception (2nd best of the year) peaking the late afternoon of the 21st.

May 6 — *METEOR SHOWER* — Very good *Aquarids* shower (annual) peaking shortly after noon LST. This shower has been known to be misinterpreted as "weak E skip" because of its strength and frequency.
—R.B.C.

ALLOCATIONS CHANGES PROPOSED TO THE FCC

In a public notice dated March 17 the FCC announced the following "changes in existing allocations" as petitioned by various interested parties.

Terrytown, Nebraska

Radio station KTCI requests that a VHF channel be allocated in that city. Under the present allocations scheme no channel is available there. Three alternatives are proposed by KTCI. Under the first proposal channel 13 allocated to Alliance, Nebraska would be moved to Terrytown. Channel 21, also allocated to Alliance would remain in Alliance.

Alternate plan number two would place channel 8 in Terrytown, removing 8 from Laramie, Wyoming. Channel 18, also allocated to Laramie, would remain there.

Under complex plan number three channel 11 would be moved to Terrytown through a series of channel shifts that would affect present allocations as far west as Vernal, Utah!

Lexington, Kentucky

The National Educational Television and Radio Center, Washington, D.C. has requested that a non-commercial educational allocation be made in Lexington, Kentucky. The requested channel is 47, and the allocations moves would involve either "dropping in 47" in Lexington (plan A) or moving allocations in Richmond, Kentucky and Bristol, Virginia to add channel 46 to Lexington for educational purposes.

TWO "U's" REQUEST "V" ALLOCATIONS

Rockford, Illinois

Television station WTVO (39) requests that allocations in Madison, Wisconsin and Fond du Lac, Wisconsin be shifted to allow WTVO to operate on VHF channel 3. WREX-13 now operates in Rockford. Channel 3 would come from Madison which would be relegated to an all-UHF status under the proposal.

Milwaukee, Wisconsin

WXIX-TV, currently holding a license for channel 18 in Milwaukee, requests amendment of FCC rules to allow channel 8 to be used in Milwaukee. WXIX also asks that it be allowed to use both channels (8 and 18) indicating it would simulcast the majority of the day, "although a portion of the day on channel 18 would be donated to area educational TV proponents.

FLASH!

CASTRO TAKES DELIVERY

... One Million Watt BCB Transmitter

Informed sources in Havana report to HORIZONS PUBLICATIONS a recent shipment of materials from Czechoslovakia including a one million watt medium wave transmitter. Castro has been repeatedly irritated over the activity of a "privately owned" station on Swan Island, in the Caribbean which has been violently anti-Castro. Fears for the sanctity of North America medium wave frequency allocations are increasing as Castro's super-power transmitter gears for 24 hour operation.

Details in the May DXing HORIZONS.

FM/Q 

ANTENNAE SYSTEMS

GET MORE FM STATIONS WITH THE WORLD'S MOST POWERFUL FM BROADBAND ANTENNAE

To be fully informed, send 30¢ for NEW Edition of "All About FM Antennae and Their Installations" by L.F.B. Carini. Contains Directory of FM Stations and Log.



FM/Q WETHERSFIELD 9, CONN.

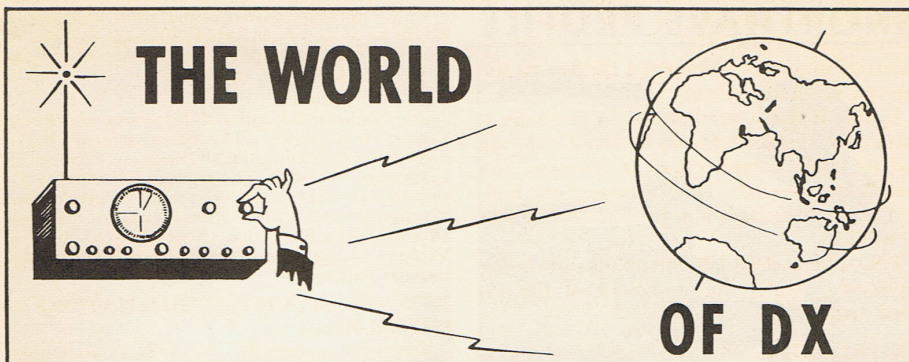

SHORTWAVE EDITOR in Charge . KENNETH R. BOORD, 948 Stewartstown Rd., Morgantown, West Virginia, U.S.A.
 CONTRIBUTING EDITORS A. R. "AL" NIBLACK, 420 Shelby Street, Vincennes, Indiana, U.S.A.
 STANLEY LEINWOLL, Radio Free Europe, New York, New York, U.S.A.
 MEDIUM WAVE EDITOR GLEN KIPPEL, 905 So. 2nd Avenue, No. 3, Sterling, Colorado, U.S.A.

FEAR NOT!

. . . DXing Horizons Will Continue

OK . . . so you like the name! Quite frankly *so do we*. Shortwave-medium wave readers are hereby informed your May issue of the magazine will continue the name "DXing Horizons" and be devoted entirely to shortwave-medium wave DXing AND Citizens Band Radio. Shortwave editor Ken Boord and his fine staff have their assignments . . . so watch out because DXing Horizons is about to be reborn! NOTE: Please do not write Horizons Publications about changing your subscription over, IF you have already contacted us. *The switch is automatic.*

The new DXing Horizons will be mailed May 10, so gauge your reception date accordingly.

MUCH-MUCH SHORTWAVE INTEREST
 . . . 100,000 strong!

A major manufacturer of fine business type shortwave receivers (general coverage and ham) is putting the finishing touches on a 64-page "Guide to Shortwave Listening." A must for every SWL (and it will be FREE!), so watch this page for further details.

WORLD RADIO HANDBOOK
 . . . Looking for Writers

Our friend O. Lund-Johansen, publisher of WRH and many other fine publications for DX fans is putting together a new GUIDE TO WORLD LISTENING. This one won't be free (like the previous item) but it will be well worth whatever the cost (always moderate with WRH publications). The important point is that Publisher Lund-Johansen is looking for

talented SWL types to prepare manuscripts for his new Guide. Write him at "Lindorffsalle 1, Hellerup, Denmark" if you qualify.

NEW HALLIE PRESIDENT
 . . . Robert F. Halligan



In Chicago, March 10, Robert F. Halligan was elected as president of the *Hallicrafters Company*, succeeding his father William J. Halligan, Sr. who founded the company in 1933! Robert F. joined the firm in 1950, has
 (Continued on page 35)

SHORTWAVE PROFILE

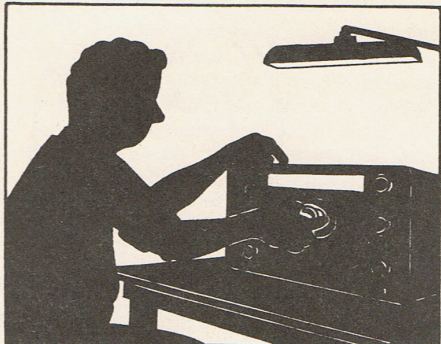

**Mr. Albert K. (Ab) Saylor
Quantico, Virginia, U.S.A.**

"I first became interested in radio in 1920, when Dr. Frank Conrad of WESTINGHOUSE in Pittsburgh was testing with music and voice transmissions over his 'ham' station with the call of 8XK," says Albert K. (Ab) Saylor, 301 Broadway, Quantico, Virginia, U.S.A., who is truly a "veteran" in the field of radio listening!

"We had to use crystal receivers of our own construction in those days, usually with coils made on oatmeal boxes," Ab continues. "Early in 1920, it was possible to buy crystal receivers from a department store in Pittsburgh, with which pioneer radio 'fans' could listen to 8XK. But the prices were rather high, I could not afford to buy one, so I built my own.

"I heard my first 'regular' radio broadcast from station KDKA, Pittsburgh, on November 2, 1920; this was the first broadcast put on the air from KDKA. It featured the election returns when Warren G. Harding was elected President of the United States.

"And I have been listening ever since! I have seen radio broadcasting develop from birth to its marvelous world-wide status of today! In the early days, all broadcasting stations had to operate on 360 meters. All 'hams' were found on 200 meters—and below.

"Of the early sets to come out after KDKA got going well, one by DeForest was a regenerative receiver using one Honeycomb Coil Tuner and two stages of Audio-frequency amplification. It sold for \$150, without accessories. Shortly after that, DeForest put out a set (Model MR-6) which operated on dry batteries, using four WD-11 tubes.

"I built a set similar to this one. And from then on I built many sets of different types—from crystal receivers to the large super-hetrodynes—including the Haines, LaCault Utradyne, and the E. H. Scott, the latter being far the best of them all.

"With such a receiver—constructed from the first kit that Mr. Scott sold to the public, I broke his own DX record. He visited Tasmania and while there had special broadcasts from America sent out for him to try to pick up—which he did. He heard the California stations, while I logged VK3ME, Sydney, New South Wales, Australia (on the broadcast band). Thus, this was better than Mr.



Truly a veteran radio listener is Albert K. (Ab) Saylor of Quantico, Virginia, U.S.A. He built his first (crystal) set back in 1920, and listened to the first regular radio broadcast from KDKA, Pittsburgh, Pa., in November 1921.

Scott did! This receiver used eight tubes—seven 201A, and one 112 tube. It employed dry batteries and a loop antenna.

"In the late 1920s, my best BCB reception was from Sydney, Australia, and New Castle, England.

"I have been in the shortwave listening hobby since it began. I prefer DXing on the low-frequency shortwave bands since stations in those bands offer a greater challenge; there's more 'fun' in dragging them in!

"My equipment today includes a HALLICRAFTERS SX-71, a HALLICRAFTERS SX-24, a RME DB-22A preselector, a WILCOX-GAY tape recorder, an all-wave crystal receiver and an antenna tuner, both of my own design.

"In point of years of listening, I believe that I am one of the 'oldest' shortwave listeners."

Although Ab does not mention it, he has rendered much assistance to shortwave stations (particularly Radio 4VEH, "The Evangelistic Voice of the West Indies," Cap Haitien, Haiti, West Indies), helping them to locate on more favorable channels. He has also given your DXH Shortwave Editor and many other SWLs valuable suggestions with regard to antennas, antenna tuners, and modification equipment.

It is with more than ordinary pleasure that your Shortwave Editor dedicates the April DXH Shortwave Department to this loyal friend and supporter—one of the world's top veteran radio listeners and reporters, Ab Saylor!

—KEN BOORD

IN MAY

... "ALL NEW" DXing HORIZONS

DX readers will find fascinating reading in the May issue of DXing Horizons, captained by our *new* very able *Managing Editor Tom Kneitel*, formerly with Popular Electronics Magazine. Watch for it! (Out May 10.)

MEDIUM WAVE

Edited by DXing Horizons
Medium Wave Editor
Glen Kippel

DXing HORIZONS

BCB PROPAGATION

During the past two months CRPL reports have indicated extremely low magnetic activity, a good DX sign. Reports indicate that the best conditions, especially on northern paths, have occurred the first weekend of each month. The next three weeks are known to be best for Down Under reception, but long-skip conditions are expected to deteriorate rapidly after the end of April. However, alert DXers should keep active throughout the summer months, for it is possible to log Australia in mid-summer (and it has been done!) as well as the usual LA's.

NEW DEADLINE...

With our new publication date of the 10th of each month, starting with the May issue, the deadline will be advanced. For the May issue, have your reports in Sterling by the 18th of April.

LA CONTEST...

Entrants in the Christmas DX Contest should immediately file with your Editor a list of eligible veries. Unofficial leaders are Millar, Washington, 93 points; Hauser, Okla., 99 points; and Tavares, Brazil, 85 points. Send your list of Xmas veries for an official standing!

Medium Wave Log Book

All times are in 24 hour EST. Please make your reports conform to the following standards.

AMERICA

- 638 SPAIN—RNE, Sevilla, heard arnd 1755 w-operatic music, vy clear on peaks. (Cox, Dela.)
- 640 Canada — CBN, St. John's, Newfoundland, hrd w-ex. level to s-off 2235. (Cox)
- 644 ANTIGUA (BWI)—Antigua B-C Serv. (NOT Barbuda as reported last month) irreg. arnd 1830, is 500 watts. (Cox, Dela.)
- 647 England—BBC, Daventry, ntd 2310 in Russian (Cox)
- 665 Syria—Damascus, tentative at 2340 on 3-2 and 1930 on 3-4, weak. (Cox)
- 692 Cyprus—Nicosia, tentative at 2350. (Cox)
- 735 Colombia—HJCU "R. Tricolor," Bogota, good at 1902 w-ID. (Cox)
- 750 Japan—JOIB, Sapporo, ID w-call, lady announcer, well atop WSB at 0530. (Millar)
- 770 Australia—3LO, Melbourne, weak at 0500 ID. (Millar, Wash.)
- 770 Colombia — HJDK, Medellin, strong 0555-0600. (Millar)
- 773 SPAIN — Valencia ntd weakly in Sp. from 1800. (Cox, Dela.)
- 820 NEW ZEALAND — 4ZA tentatively ID w-gongs and commercials in English 0600. (Millar, Wash.)
- 840 Australia—4RK, Rockhampton, logged 0500-0535, weak. (Millar)
- 870 JAPAN—JOLB, Fukuoka, good ID w-call at 0430. (Millar)

- 872 SPAIN—R. Zaragoza, good 1755-1800. (Cox, Dela.)
- 1040 CHINA—"R. Peking" outlet, possibly Shanghai, logged 0715-0800, weak but positive ID. (Millar, Wash.)
- 1052 LIBYA—Tripoli, ntd late as 1915 w-Ramadan prgms, poor sig. (Cox)
- 1097 CZECHOSLOVAKIA — Bratislava, ntd w-chime IS from 2258, ID by lady in native 2259, nx 2300, good. (Cox)
- 1133 SPAIN — EAJ28, Bilbao, in weakly 1800. (Cox)
- 1133 YUGOSLAVIA—Zagreb in at 2315, weak. (Cox)
- 1214 England—BBC Light Prgm., hrd w-Big Ben 0130, good. (Cox)
- 1304 MALI—Dakar, Senegal ntd w-tomtom IS from 0127, s-on 0130, then into native music. Fair on peaks. (Cox)
- 1370 Puerto Rico — WIVV, Vieques, s-on 0430. (Millar)
- 1484 LIBYA—Benghazi ntd w-Arab music and talks 1900-1930 also 0045, fair on peaks. (Cox)
- 1578 ITALY—Low power net (likely Ancona or Verona—Ed.) hrd w-Rome IS 0030, then opened in Italian. (Cox)
- 1586 Germany — NDR, Oldenburg, hrd 2300 w-time pips, ID, 20 over S9. (Cox)
- 1594 France—Nimes, weak 0045. (Cox)

ATLANTIC

- 730 TRINIDAD — VP4RD hrd 2150 w-cricket. S3. (Ericson)
- 1052 Libya—Benghazi hrd w-Ramadan serv. 2100, S7. (Ericson)
- 1097 SPAIN—New station EOP R. Popular de Albacete hrd several nites closing arnd 2000. Wants reports. (Ericson)
- 1115 SPAIN—EFJ19, R. Juventud de Murcia heard closing 2100, test. S8. (Ericson, Sweden)
- 1260 Canada—CFRN, Edmonton, hrd several nites lately 2200. (Ericson)
- 1286 Israel—Galei Zahal-Kol Israel hrd 1200-1215 w-Arabic news, S7. (Ericson)
- 1322 SPAIN—New EOP12, R. Popular de Murcia hrd every nite testing w-IDs and music. Address: Apartado de Correo 262. All reporters will have a record played. Hrd mostly 2000-2300. (Ericson)
- 1340 Iran—Teheran hrd nitely w-Ramadan festival, vy strong, after 2200. (Ericson)
- 1344 KUWAIT — Kuwait hrd nitely 2100 w-Ramadan, S6-7. (Ericson)
- 1493 IVORY COAST—Abidjan hrd 1800 w-French music, S4 w-QRM. (Ericson)
- 1500 HAITI—A new one hrd several nites arnd 2100, sounds like "Poste 4VGB Port-au-Prince, Haiti." Often has fine classical piano music. Who? (Ericson)
- 1594 MOROCCO — AFRS Morocco hrd several nites at 2200 w-DJ prgms. No clear ID as there are other stns on the freq, S-4-7. (Ericson)

(Continued on page 35)

ENGLISH LANGUAGE SW HORIZONS

"A monthly review of 'casts heard in North America in the English Language"

By
A. R. "Al" Niblack

MONTHLY LISTENING TIPS

The following listing consists of stations currently heard throughout North America during their ENGLISH language sessions.

(Times to tune are in the 24 hour GMT, frequencies in megacycles. EST subtract five hours, CST subtract six hours, PST subtract eight hours. E indicates for LISTENERS IN EAST COAST NORTH AMERICA AREA; C, IN THE CENTRAL U.S.A. AREA; and, W, IN THE WEST COAST NORTH AMERICA AREA.

0000-0100

WINDWARD IS. (Grenada) 11.955 (NEW), C
ITALY (Rome) 9.575, C

0100-0200

CEYLON (Colombo, 0130 s-on) 15.265, C
JAPAN, Tokyo, 0120 s-off) 17.725, 21.520, W
(acknowledgment to Balbi, Calif.)

0200-0300

CANADA (Montreal) 9.585, C
USSR (Moscow) 11.690A, C
CHINA (Peking, 0200, N-E) 11.945, C

0300-0400

BRITISH HONDURAS (Belize, 0330, N-E)
3.300, E (acknowledgment to Saylor, Va.)

ENGLAND (London) 6.100, C
SWEDEN (Stockholm, 0315, N-E) 11.705, W
(Balbi)

0400-0500

NEW ZEALAND (Wellington) 15.280, W
(Balbi)
SWITZERLAND (Berne, 0415 s-on) 9.535, C

0500-0600

NIGERIA (Kaduna, 0530, N-E) 3.326, E (acknowledgment to Cox, Dela.)
UNION OF SO. AFR. (Paradys, 0500, N-E)
4.810, E (Saylor)
(Paradys) 7.229, 9.680, W (Balbi)
NIGERIA (Enugu, 0530, N-E) 7.285, E (Saylor)
JAPAN (Tokyo, 0120 s-off) 17.725, 21.520, W
(Balbi)

0600-0700

NIGERIA (WEST) (Ibadan, 0600, N-E) 6.185,
W (Balbi)
UNION OF SO. AFR. (Paradys, 0610, N-E)
9.720, E (Saylor)

0700-0800

LIBERIA (ELBC, 0700, N-E) 3.255, E (Saylor)
GHANA (Accra, 0700, N-E) 3.365, E (Saylor)
NIGERIA (Lagos) 4.990, E (Saylor)
AUSTRALIA (Melbourne) 11.710, W (Balbi)

0900-1000

NEW ZEALAND (Wellington) 6.080, 11.780,
W (Balbi)

1000-1100

AUSTRALIA (Brisbane) 4.920, C

1100-1200

SINGAPORE (FBS, 1100, N-E) 5.010, W (Balbi)
INDONESIA (Djakarta, 1120, N-E) 11.795, E
Saylor)



The "SWEET SIXTEENS" songbirds of Holland (directed by Lex Korsemeier) taking a cue from the colorful and well-known Edward Startz (seen in lower right hand corner) in the "Happy Station" studio of Radio Nederland, Hilversum, Holland.

1200-1300

KOREA (NO.) (Pyongyang, 1230, N-E) 6.250,
E (Cox)

1300-1400

AUSTRALIA (Melbourne, 1315) 11.710, W
(Balbi)

1400-1500

PAKISTAN (Karachi, 1445, s-on) 6.235 (NEW),
7.275 (NEW), 11.674, W (Balbi)
SWEDEN (Stockholm, 1445, s-on) 15.240,
17.845, W (Balbi)

1500-1600

JAPAN (Tokyo, 1525, s-on) 15.235, W (Balbi)

1600-1700

AUSTRALIA (Melbourne, 1615) 11.710, W
(Balbi)

1700-1800

WINDWARD IS. (Grenada) 15.395A, C

1800-1900

YUGOSLAVIA (Belgrade, 1830, N-E) 9.505,
E (Cox)
GHANA (Accra) 11.797AV, E (Cox)
MOROCCO (Rabat, 1830, requesting reports)
11.735, C

1900-2000

MONACO (Trans-World Radio) 6.115, E (Cox)

2000-2100

IRAN (Teheran, 2045, N-E) 7.032, E (Cox)
BELGIUM (Brussels, 2030, N-E) 11.840
(NEW) C

KATANGA (Elisabethville, 2025, N-E) 11.866,
C

GERMANY (FED.) (Cologne, 2000, ENGLISH
ID during Arabic session) 11.895 (NEW), C

2100-2200

HOLLAND (Hilversum, 2115, s-on) 11.730, C

2200-2300

NEW ZEALAND (Wellington) 15.280, W
(Balbi)

2300-2400

BULGARIA (Sofia) 9.700, C
ARGENTINA (B. Aires) 11.730 (seemingly on
irregular schedule) C
CANADA (Montreal, 2305, Mailbag on SUN-
DAYS) 11.760, 15.190, W (Balbi)

Change of the seasons from winter to spring should bring an improvement in propagation conditions and signals from many parts of the world will increase in strength. Longer days indicate that your DX efforts should soon be concentrated on the frequencies above 6.200 mcs. —A.R.N.

AT FADE-OUT

(The following pages of DX News represent the combined listening and reporting efforts of DXing Horizons SW readers in 73 countries, detailing the very latest available SW DX news. All times are in GMT.)

According to word direct from Hardy Hayes, International Service Director, HCJB, Quito, Ecuador, the station's "Party Line" feature is to be REDESIGNED shortly especially for DXers. Details will be announced as soon as they are available. "Party Line" is the first hour-long feature of the "Ecuadorean Echoes" session beamed to the Americas on 15.115, 11.915, 9.745 on the FIRST TUESDAY OF EACH MONTH beginning at 0200.

Now for this month's reports (GMT):

AFGHANISTAN—R. Kabul, 9.705, hrd 1900 in ENG. (B. Hankins, Pa.) Has Fr. 1830. (Pearce, England) Seems to have DROPPED 5.006; observed on OLD 4.750 w-ENG. 1600-1630, N-E 1600. (Jensen, Denmark)

ALBANIA—R. Tirana, 7.157, noted 2230-2245 w-N-E; s-off 2300. (Saylor, Va.; Rowell, Minn.) Observed on 7.851 Mat 1915 w-N-Ar. by woman; weak. (Cox, Dela.)

ANGOLA—R. Diamang, 9.475, Dundo, noted s-off 1930 w-"A Portuguesa." (Schwartz, Berg, Conn.) Veri rcd via registered airmail from this one. (Washington, N.Y.) CR6RZ, Luanda, hrd well 2100-2230 on NEW 17.705, REPLACING 17.795; also noted parallel on 4.955. (Legge, Va.; Rowell, Minn.; Balbi, Calif.) R. Benguela, 5.045, hrd 1330; veries by QSL cd. (Parker, Va.)

ARGENTINA — LRA, 11.730, Buenos Aires, noted w-ENG. 2300-2400. (Lund, Iowa; Pearce, England)

AUSTRALIA—VLC11, 11.710, has REPLACED 11.810 to WCNA 1514-1615. (Balbi, Calif., others) Hrd well in W. Va. (KBLP) And in Minn. (Rowell) Brisbane, 4.920, hrd 1230-1300 w-pop mx, N-E Perth, 9.610, noted 1400-1445 w-pop mx, excellent sig; Melbourne, 6.150, hrd 0900-0930 w-N-E, pop mx, excellent level. (Santos, Calif.)

AUSTRIA—NEW sked as ANNCD by R. Austria is 6.155, 0500-0800, 1400-1600, 1800-2100; 7.155, 0800-1000, 1200-1400; 7.200, 1000-1200; 9.770, 1600-1800. (Pearce, England) Hrd recently on 9.540A at 0045 w-ID in ENG., Ger., Fr. arnd 0100. (Bohac, N.J.)

AZORES—CSA97, 4.865, Ponta Delgada, noted 2236 w-N-Pt.; light mx 2253; hrd to 2300; fair in Mo. (Buchanan)

BARBADOS—Barbados Radiodiffusion, Bridgetown, was hrd on certain SATS. in LATE FEB., EARLY MARCH over ZNX32, 7.547, fading in arnd 2000, vy gud by 2100; had horse races, pop mx. (Bohac, N.J., others)

BELGIUM—Xmsns to N. AM. frm Brussels are now 1700-1745, 2115-2300, 15.335; 2315-0100, 11.850; ENG. 0045-0100. (Legge, Va.) Noted on 11.840M, strg, w-N-E 2030-2040; hrd on NEW channel 15.435 to 1745 s-off, mx and lang. (Niblack, Ind.)

BRAZIL—R. Cultura de Sao Paulo noted on NEW 17.815 fq 1800-2200; R. Globo, Rio de



The TRUTH about RADIO SWAN

On page 38 in the March DXing Horizons—Horizons Publications' promised the first photos (exclusive!) of Radio Swan. The single photo above is the only one ready at press time for public showing.

However, in the May issue of the "all new DXing HORIZONS" the cover feature story "The Truth About Radio Swan" will reveal in shocking reality "who operates Radio Swan," and "why Radio Swan doesn't need to make money as a "commercial" radio outlet.

Spread the word . . . this story promises to be the most exciting shortwave reading in a decade!

Janeiro, is ACTIVE on 11.805, w-normal s-off 2230, but is hrd irreg to 0300. (Legge, Va.)

BULGARIA—R. Sofia, 9.700, 11.850, hrd w-N-E 2130; had MAILBAG 2145. (Lund, Iowa)

CAMEROON REP. — R. Yaounde, 4.973, hrd 1700 w-N-Fr., weak sig in Va.; R. Doula, 6.115, hrd 1045 w-N-Fr., weak; R. Garoua, 5.010, noted 1815 w-N-Fr., weak. (Parker)

CANADA—VFG, 8.828.5, Gandier Radio, Newfoundland, hrd 2235, 2305, 2355 and other times giving wx rpts in ENG., straight speech. (Stephenson, Okla.)

CANARY IS.—R. Ia Palma, 7.345, noted 2230-2300, mx, Sp. (Rowell, Minn.) R. Atlantico, 7.000, hrd 2215 w-Sp. mx. (Parker, Va.)

CEYLON — Commercial Serv. of R. Ceylon, 15.265, Colombo, hrd well 0240 tuning to 0330 in ENG. to Asia; excellent sig in Ont. (White, Canada) Vy gud in N.J. s-on 0130 w-pop records. (Bohac) Hrd on 9.520 at 0130-0400 w-native-type prgm; at times has QRM frm Denmark, same channel. (Rowell, Minn.) National Serv., 11.770, usually is FB sig w-native mx 1600-1730 c-d; NO LONGER uses "Strike Up the Band" at c-d, but a march tune. Commercial Serv., 9.520, uses same sig tune at c-d 1645. (Kippel, Colo.)

CHINA—H. Serv., 4.980, Fukien, noted 1234 w-talk by YL in Chinese. (Buchanan, Mo.) R. Peking, 7.330A, hrd 2300 s-on in oriental lang; overrode CHU, Canada, 7.335. (Bohac, N.J.)

CLANDESTINE—R. Independiente, 6.950, hrd 2000-2330 w-Sp. talks. (Saylor, Va.) Noted in N.J.

on 10.110 at 2200-2400 w-Sp. talks, SINPO 44444. (Newhart)

COLOMBIA—HJEX, R. Pacifico, 6.054, Cali, QSL'd w-white cd, showing man in green shirt smoking a pipe, turning radio dials; all stns of RCN Net listed, w-checkmark at appropriate outlet hrd; enclosed pink, red, and blue pennant w-2-page hand-written ltr in Sp. R. Sutatenza, 5.075, Bogota, hrd 0100-0310 w-mx, talks in Sp. (Stephenson, Okla.)

CONGO REP.—R. Brazzaville, 11.725, noted 0715-0730 w-mx. (Alcock, Fla.) Hrd opening 2315 in Fr.; N-Fr. 2330; has ENG. 1700-1730. (Pearce, England) Observed on 15.190 at 2015-2100, Fr., mx. (Rowell, Minn.)

(REP. OF) THE CONGO—Accdg to skds crd frm Radiodiffusion Nationale, Leopoldville, 11.755 is used to EUR. DLY 1900-2330, W-N-E 2145, to N. AM. DLY 0000-0230, w-N-E 0045; QRA is Box 7699. (Sisler, W. Va.; Rowell, Minn., others) Hrd s-off to EUR. 2300. (Balbi, Calif.) Accdg to ANNCMT hrd, is using the OLD OTC xmtr w-50 kw., but said 100-kw. xmtr will go into operation SOON, at which time the N. AM. SERV. will be EXTENDED. (Berg, Conn.)

COSTA RICA—R. Relej, 6.006, hrd 0510 w-mx, commercials in Sp. (Neves, Calif.)

CUBA—A stn ID as Cuba was hrd 0200-0315 on 11.700A; started w-propaganda songs in Sp., and said was "testing." All-Sp. (Ford, N.J.) Havana's 11.762A outlet noted MOVED to 11.772V, opening arnd 0000 and hrd to AFTER 0500. (Rowell, Minn.) QRA is Box 7026, Habana, Cuba. (WRHB)

CZECHOSLOVAKIA—R. Prague noted MOVED frm 7.340 to 7.345 recently to N. AM frm 0300A. (Bohac, N.J.) Noted on 9.550 at 1700-1727 s-off in Eur. langs. (Rowell, Minn.)

DENMARK—R. Denmark, 15.165, noted 1630-1700 w-mx, N-E. (Rowell, Minn.)

DOMINICAN REP.—R. Caribe, 3.322, 9.485 noted DLY 2300-0400. (Rowell, Minn.) R. Caribe now has ENG. ID each 10 min; says, "This is Radio Caribe. We are broadcasting from the Happy Studios in Ciudad Trujillo in the Dominican Republic." Noted now at least to 0700 on 3.322, 9.485. (Cushen, N.Z.)

DUTCH NEW GUINEA—R.O.N.G., 6.070A, Biak, now b-c a feature called "Islands Listeners Club," in ENG., Dutch, Indonesian SAT. 1245-1315. (Tabuchi, JSWC)

EGYPT (UAR)—R. Cairo, 17.920A, hrd 1645; all-Ar.; strg sig. (Neves, Calif.) Noted in Colo. fine sig but w-some QRM frm Dutch CW stn 1628-1655 c-d; dance and Ar. mx; multi-lingual ID 1650; in ENG. ID as "United Arabic Republic Amharic program, Cairo." (Kippel) Cairo noted on 7.050 at 1930 w-Ar.; N-E hrd 0630-0700. (Saylor, Va.) Hrd on 17.892 at 1710-1740 in Swahali. (Rowell, Minn.)

EL SALVADOR—YSU, 6.187, San Salvador, noted 0000-0500; ANNCD in ENG. 0400, aksed for rpt; YSU plus YSS, 9.552, seem to be the only ACTIVE YS stns now. (Legge, Va.)

ETHIOPIA—R. Addis Ababa, 11.955, noted in ENG. 1810-1830, Fr. 1830-1849A c-d-for WN. EUR.; ANNCS 17.775 parallel for W. AFR. (Rowell, Minn.; Pearce, England, others)

FINLAND—Frm April 1, sked of Helsinki to N. AM. was CHANGED frm 1130-1400 to USUAL SUMMER hrs 2030-2300 on 15.190, 17.800. (Legge, Va.) Helsinki, 11.960, hrd opening 1600, c-d 1830. (Pearce, England)

GERMANY (WEST)—NEW fqs used by DW, Cologne, are 6.145, 0145-0445; 11.895, 1715-2015; 21.730, 1245-1545. (Legge, Va.) DW noted on 6.145, parallel 5.980, 9.735 at 0145-0445; the 6.145 outlet has hvy QRM frm PRL9, Brazil, to 0415, then is clear; accdg to ltr rcd. is beamed to W. N. AM. experimentally, but carries C. AM. prgm. (Woltjen, Utah)

GHANA—R. Ghana, Accra, noted on NEW fq 7.295 at 2100 w-N-E. (Roth, Conn.) R. Ghana, 11.797V, hrd TESTING 2130-2220, N-E 2215. Noted DLY EXCEPT SAT. on 9.640 frm 0700. (Balbi, Calif.; Pearce, England) Hrd w-N-E 2000-2005 on the 11.797V outlet. (Niblack, Ind.; Bohac, N.J., others) Accra, 4.915, noted 0615 w-relay of BBC's "Radio Newsreel"; gud sig in Ont. (Bromley, Canada) Hrd on 3.366 at 0600 w-local N-E, fine sig in Mo. (Combs)

GREECE—R. Athens has Fr. 1720, ENG. 1730 on 9.605. (Pearce, England) VOA, THE COURIER, 9.530, Rhodes, noted 2200 w-N-E and ID 2215, then talk; ID, s-off 2230. (Buchanan, Mo.)

HAITI—4VEH, Cap Haitien, is widely rptd hrd on its NEW 100-w outlet 21.520 arnd 2245 OR EARLIER to 0430, parallel 6.121, 9.773.

HONG KONG—ZBW, 3.940, fair 1330-1400 w-Am. rcdgs, annrc in Chinese. (Balbi, Calif.)

HOLLAND—R. Nederland's recent TESTS to N. AM. 2000-2015 on 17.810, 15.445 were rcd w-excellent sigs. (Balbi, Calif.; Niblack, Ind.; Rowell, Minn., others) Hrd to N. AM. 2115-2205, 15.445, 11.730, both gud level in Calif. (Balbi) ADDITIONAL N. AM. skeds include 0130-0230 (MON. 0200-0330), 6.025, 9.590 in ENG.; 0130-0320, 9.715, 11.730, in Dutch. (Legge, Va.) Noted on 25.610 at 1500-1530 in Dutch to AFR.; observed DLY now on UNLISTED 11.710 channel w-Dutch, mx. (Rowell, Minn.)

HONDURAS (BRT.)—R. Belize, 3.300, noted 0300-0315 w-VOA N-E. (Saylor, Va.) Hrd in Texas 0145. (Hathaway)

INDIA—AIR, 11.790, Delhi, hrd 1230-1315 in Tibetan. (Tully, Ont., Canada) Hrd on 9.640, 11.890 at 1945-2045 in ENG. (B. Hankins, Pa.) CURRENT sked for Delhi's External Serv. in ENG. includes 0030-0040, 9.525, 11.895; 0430-0440, 17.855, 21.620; 1000-1100, 15.160, 15.310, 17.705, 17.725, 21.615; 1330-1430, 17.705, 21.560; 1545-1555, 15.105, 17.830; 1945-2045, 9.640, 11.790, 11.890, 15.240. (Legge, Va.)

INDONESIA—YDG3, 4.875, Surakarta, RRI, noted 1236 w-N-Indonesian; fair level. (Buchanan, Mo.) Excellen w-N-E 1120-1125, then mx, parallel 9.585. (Saylor, Va.) Hrd opening in ENG. 1900 on 9.585, 11.710A. (Pearce, England) The 25-m. outlet w-ENG. 1430-1530 is 11.793M, NOT 11.785 as listed in WRH61. (Cox, Dela.)

IRAN—R. Teheran hrd w-fair strgth on 7.030 at 0230-0500, after it tried several other fqs in 41-m.b. (Legge, Va.) MEASURED 7.032 when opening in ENG. 2045, ID by woman, then N-E; strg but w-CWQRM. (Cox, Dela.)

IRAQ—YIH62, R. Baghdad, 6.030, during Ramadan was tuned w-special prgm in Ar. 0100; much strgr on parallel 7.180. (Berg, Conn.) Hrd opening ENG. 2030 on 6.030; polittical commentary, nx. (Pearce, England)

ISRAEL—Tel Aviv, 9.009, hrd in ENG. 2015-2045. (B. Hankins, Pa., others)

ITALY—R. Roma is again using 11.905 at 2230-0325 to N. AM., REPLACING 6.010; ENG. 0030, 0305. (Legge, Va., Rowell, Minn.)

IVORY COAST—R. Abidjan, 11.820, strg 2100-2400 but w-QRM frn XEBR, Mexico; also observed 0630-0800 parallel 4.940, w-N-Fr. 0645, 0730. (Balbi, Calif.) Noted w-"powerhouse"-like sig 1800 w-N-Fr., but was "wiped out" by another stn 1830. (Berg, Conn.) Hrd in Va. 1745-2330, w-severe QRM frn BBC AFTER 1830; is 100 kw. (Legge) Noted w-N-E 1845-1900, then pop mx to 1915, gud level, but w-some QSB. (Roth, Conn.)

JAMAICA — Cable & Wireless, Ltd., 12.050, Kingston, observed TESTING in ENG. 2050. (Niblack, Ind.) Hrd 0255-0315 on 5.205A, 5.915A w-SSB TEST xmsn. (Bohac, N.J.)

JAPAN—R. Japan began xmsn to AFR. April 1 in ENG., Fr., Japanese 1930-2030, 11.705, 9.525. (R. Japan via Balbi, Calif.) Is using 21.520, 17.725 (REPLACING 17.855), 15.135 to ECNA 0030-0130; 9.525, 11.800, 15.235, 17.825 (NOT AUDIBLE) to WCNA 0500-0700. (Balbi, Calif.; Legge, Va.; Rotech, Ill.)

JORDAN—Latest sked of Amman is 0300-0600, 7.155, 11.710; 0615-0805, 9.530, 11.710; 1100-1305, 9.530, 11.710; 1400-2200, 7.155, 11.710. (R. Australia, others) However, the 25-m.b. outlet MAY be 11.810 instead of 11.710. (Ed.) Hrd in Minn. 0330-0615. Is noted STILL on 11.810 frn arnd 2030 (AFTER Rome s-off its session in Ar., It. to S. Asia) to 2200. (Rowell, Minn.)

KATANGA — R. Katanga, 11.866, Elisabethville, hrd w-N-E 2015. (Bohac, N.J.; Niblack, Ind.; Saylor, Va., others) Said recently would have PRINTED QSLs son. (Bohac) Also hrd w-N-E 0700; noted c-d 2100. (Balbi, Calif.)

KOREA (NO.)—R. Pyongyang, 6.251, fair 1230 w-chimes IS, ENG. ID by man, and then N-E. (Cox, Dela.)

KOREA (SO.)—Seoul is noted 0530-0630 to WCNA, 15.125, 11.930; 0730-0830 to Hawaii, 15.125; 1430-1530 to U.S.A., 11.930; 1600-1700 to Hawaii, 11.930; also noted 2200-2300 on 11.930. (Balbi, Calif.)

LAOS — Radiodiffusion Nationale Lao sked, accdg to ltr, is 2330-0100, 0500-0630, 1100-1345, 6.130, 6.150, 7.145. (WRHB)

LIBERIA — ELBC, 3.255, Monrovia, observed 0700 w-N-E. (Saylor, Va.) ELWA, 21.535, Monrovia, noted 1920 w-religious prgm in lang; 1930 ID in ENG.; c-d 2229. (Ferguson, N.C.) ELWA has ENG. 0600-0745, 11.980; 0630-0830, 4.770, 21.535; 1100-1145, 11.825; 1415-1430, 15.085; 1630-1730, 11.825, 21.535; 1930-2000, 15.085; 1945-2045, 4.770; and to N. AM. WED. ONLY 0100-0345, 11.825, 21.535. (Balbi, Calif.)

LUXEMBOURG—R. Luxembourg is again ACTIVE on 15.335, hrd w-fair sig 1200-1700. (Legge, Va.)

MALAGSY REP.—Stn hrd on 7.153A w-native songs, annmts in Fr. to 0445 fade-out, w-hvy QRM frn Amman, Jordan, 7.155, is believed to be R. Tananarive. (Washington, N.Y.)

MALI REP.—R. Bamako, 7.075A, noted 0700 w-native prgm; 0800 N-Fr.; ID w-"Ici Radio Mali, Bamako." (Saylor, Va.) Observed on 4.835 at 0645-0715. (Roth, Conn.)

MAURETANIA — R. Mauretanie varied w-accurate and most complete ltr, along w-what must be a NEW tan-and-yellow SOROFOM cd and a set of beautiful Senegal stamps; LISTED 7.245, instead of 9.610, for its (local) mid-day xmsn. (Washington, N.Y.)

MEXICO—XDA232, 21.717, Mexico City, hrd 1700-1900 w-tuning and ID speech recording over-

and-over in Sp., under it' called Paris in ENG. (Stephenson, Okla.)

MONGOLIA (OUTER) — Ulan-Bator is sked 2300-0200, 0200-1100, 5.960, 10.910; 1100-1500, 5.067.5, 5.960; 0900-1400, 5.232, 6.383. (WRHB)

MONTE CARLO — Trans-World Radio, 9.705, strg, hrd irreg to Britain 0730-0830 in ENG. xmsn. (Balbi, Calif.) Noted TESTING on 11.720A at 1630 in Ar., w-call "Huna Monte Carlo"; asked for rpts to Box 141, Monte Carlo, Monaco. Vy strg in Calif. (Neves) Noted on 6.115 at 2000-2030 w-"Back to the Bible" session, organ mx 2030-2100 s-off. (Roth, Conn., others) This one excellent frn 1955 w-organ mx, ENG. ID 2000 and requested rpts; hrd on 9.690 frn 1835 w-religious songs in lang; ID 1852, then s-off. (Cox, Dela.)

MOROCCO—Rabat, 11.735, noted asking for rpts when closing ENG. xmsn 1830; some days is quite fair level in Ind. (Niblack) Also observed in Fla. (Alcock) Asks for rpts to Radiodiffusion Marocaine, Rabat, Morocco. (Pearce, England)

MOZAMBIQUE—CR7BG, 15.147A, noted 1550-1800; has IS on gong about every 15 min; peaks arnd 1700-1800; features world N-Pt. 1630. (Rowell, Minn.)

NEW ZEALAND—NEW sked of R. New Zealand is 1700-1945, 9.540; 1700-2230, 15.280; 2000-2245, 11.780; 2245-0545, 15.280; 0600-0845, 11.780, 6.080; 0900-1130, 11.780, 6.080; SPECIAL xmsn to Antarctica SUN. ONLY 0815-0845, 11.780. (Cushen, N.Z.; Balbi, Calif.)

NIGERIA — Ibadan, 6.185, has REPLACED 6.050, noted 0600-0730. (Saylor, Va., others) Ibadan, 7.285, noted 0600 w-BBC N-E Kaduna, 3.326, noted 0700 w-N-E Lagos, 7.255, hrd 0615 w-native mx, annmct in ENG. (Saylor) Ibadan, 6.185, noted in Calif. 0500-0800, w-N-E 0600, BBC N-E 0700. (Balbi) Enugu, 4.855, hrd 0600 w-BBC N-E, gud sig in Ont. (Bromley, Canada) Lagos, 4.990, noted in Calif. 0620 in ENG. (Riggs)

NORWAY—The wkly feature in ENG., "Norway This Week," is aired by R. Norway, Oslo, to N. AM. MON. 0200-0225, 0500-0525 on 6.130, 9.610, 11.850, 15.175. (KBLP) Also noted on NEW 21.730, REPLACING 21.670, at 1100-1220, 1300-1420, 1600-2100. (Legge, Va.)

PAKISTAN—Currently, R. Pakistan's 11.674A fq has FB sig in W. Va. 1815-1900 in beam to Turkey. (KBLP) Hrd also in N.J., ANNCS 7.010 as parallel. (Bohac) Hrd w-N-E 1445-1500 on 6.235, 7.275, 11.674A, latter BEST fq in Calif. (Balbi) Karachi noted on NEW 15.195, REPLACING 15.155, at 1345-1515; ENG. 1445. (Legge, Va.) The 11.674A outlet noted opening 1530 w-N-E at slow speed. (Rowell, Minn.) Karachi, 15.195, strg 1455 w-N-E by man, ID for "Home Service" 1500. (Cox, Dela.)

PERU—OCB63, 20.850, All America Cables & Radio, Lima, varied with white cd, printed in black; top center has globe w-legend "A. C. & R. Serves the World By Cable and Radio"; power is 10 kw., antenna is a rhombic, directed to Mexico. (Stephenson, Okla.)

PHILIPPINES—FEBC's DX18 noted on 21.515, REPLACING 21.495, hrd irreg arnd 0100; MAIL-BAG noted on MON. 1500 on DZF2, 11.920, DZH7, 9.730. (Balbi, Calif.)

POLAND—Accdg to ltr from R. Warsaw, stn has had NO xmsn to U.S.A. since Dec. 1, 1960. (Huff, Calif.) R. Warsaw noted w-N-E 0730, 0830 on 11.800, gud; ANNCD 15.275, 17.800 as parallel. (Balbi, Calif.) Hrd in ENG. 1830-1900, 6.195;

at 1930 on 9.540, 7.125. (Pearce, England)

PORTUGAL—Lisbon, 17.880, 17895, hrd 1930; on at 2100 over NEW 11.915 fq in Pt. (Balbi, Calif.) Excellent 0045-0400 to E. N. AM. on NEW 6.025, also 0000-0400 on 9.740, and on W. N. AM. beam 0200-0400, 9.635; is again using 21.495, REPLACING 15.380, 1000-1730. (Legge, Va.) Observed on the NEW 11.915 fq at 2355, strg in usual Pt. prgm; "smeared" 0000 by HCJB s-on, same fq. (Niblack, Ind.) More recently, appeared to have RETURNED to 11.840 frn 11.915 at 2100-0400. (Rowell, Minn., Balbi, Calif.)

RHODESIA—Salisbury, 3.396, noted 0404 w-annmnts in ENG. and pop mx; poor sig. (Buchanan, Mo.) FBC Afr. Serv., 4.828, Lusaka, noted 0425 w-mx requests and ENG.; N-E 0500. (Cox, Dela.)

RUANDA-URUNDI — R. Usumbura is using 6.195 w-10 kw.; sked 0430-0530, 1000-1130 (SUN. 0700-1130); 1500-2015 (SUN. 1430-2015). QSL came frn Box 1400, Usumbura. (Cushen, N.Z.)

RUMANIA—R. Bucharest, 7.195, excellent 0245 in lang; went into ENG. 0300 for N. AM.; ANNCS 11.810, 9.570, 9.510, 7.225, 7.195, 5.980. (Bohac, N.J.; Rowell, Minn.) Noted on 7.225 at 0130 w-N-E. (Saylor, Va.) And 0430. (White, Ont., Canada)

SARAWAK—R. Sarawak, 4.950, hrd 1445-1500 w-mx; c-d 1502 w-"GSTQ." (Balbi, Calif.) Noted in Mo. 1259-1338; at 1300 had ID, time pips, BBC N-E, then variety mx; fair sig but w-hvy QRN. (Buchanan) Hrd at excellent level 1300-1400 w-classical mx, talks in ENG. (Santos, Calif.)

SENEGAL—R. Senegal, 7.210, Dakar, hrd 0615 w-N-Fr., also 2245. (Saylor, Va.) Dakar, 4.950, noted 0640 at gud level in Ont. (Bromley, Canada)

SIERRA LEONE—Freetown, 3.316, hrd 0700 w-BBC N-E; weak, much QSB, but readable. (Alcock, Fla.)

SINGAPORE — BBCFES, 11.855, occasionally appears arnd c-d 1655, parallel 9.690. (Kippel, Colo.) Noted on 11.955 at 1500-1645 s-off in ENG. (Rowell, Minn.) R. Singapore has been TESTING arnd 1030-1430, including ENG. 1230, on various fqs, such as 7.250, 6.175, 6.015: ADDITIONAL TESTS were to be carried also on 4.820. The 7.250 outlet has been hrd by Balbi, Calif., 1400-1430 c-d, at rather weak level, and on 6.175 in Malayan 1330-1430 s-off, fair. Rpts should go to Head of Broadcasting Division, Ministry of Culture, Box 1902, Singapore.

SPAIN—RNE, 7.105, Madrid, noted 2020 w-ENG.; 0300-0320 w-Russian. (Saylor, Va.)

SWAN IS.—R. Swan, 6.000, noted 0000-0030 w-"Back to the Bible" session, then N-E. (Saylor, Va.)

SWEDEN—R. Sweden, 11.805, HAS REPLACED 9.725, to N. AM. 0100-0215, 0230-0345. (Balbi, Calif.) Hrd well on NEW 17.845 channel 1230-1345, 1445-1600; however, the 1400-1430 N. AM. xmsn is STILL on 17.840 w-severe QRM. (Legge, Va.)

SWITZERLAND—The International Red Cross, Geneva, TESTED in late March on 7.210 at 0600-0700, 1130-1230, w-100 kw., and 1500-1600, 2100-2200 w-25 kw. (WRHB)

SYRIA (UAR)—During Ramadan, R. Damascus, 5.704, was noted irreg w-xmsn in Ar. arnd 0230. (Berg, Conn.) UAR Administration Receiver Adjustment Station, 11.905, Damascus, hrd TESTING in ENG. 1615, excellent level in Dela. (Cox)

TAIWAN (FORMOSA)—BED56, 17.785, Tai-

pei, hrd 0130-0159 to N. AM. and HAWAII and ANNCD other fqs parallel as 11.860, 7.255, 6.095; gud to c-d. (Ferguson, N.C.; Rowell, Minn.)

TANGANIKA—TBC, 5.050, Dar-es-Salaam, hrd 0413 w-N-E; poor level w-bad L. Am. QRM. (Buchanan, Mo.) Hrd in N.J. on a SUN. 0330-0430; ENG. ID 0410, "This is the National Network of the Tanganyika Broadcasting Corporation"; N-E to 0415, then Afr. mx; excellent arnd 0345 but w-QRM at times; fades arnd 0430. (Bohac)

TURKEY—TAS, 7.285, R. Ankara, noted in ENG. 2145-2230 s-off; nx commentaries, talks, classical mx. (Bohac, N.J.; Alcock, Fla.) TAT, 9.515, excellent to N. AM. in ENG. 2315-2400. (Lund, Iowa, others) QSL'd w-light-yellow cd, printed in black, w-small crescent and star in center top; one side has fq, other has veri message. (Stephenson, Okla.)

UNION OF S. AFR.—NEW sked of SABC's Afr. Serv. is 25.800 (REPLACING 21.495), 1100-1700; 17.855, 1700-2000; 15.235, 1100-1600; 15.300, 1600-2000; ENG. on TUE., THURS., SAT., Afrikaans other days. (Legge, Va.) SABC's Commercial Serv. strg on 7.185 at 0445; Afrikaans Serv. strg on 7.285 same time. (Washington, N.Y.) SABC, 7.185, noted 0500 w-nx; hrd on 7.295 at 0500 w-nx. (Saylor, Va.)

UPPER VOLTA—R. Haute-Volta, 4.815, noted frn arnd 2100, mostly mx w-occasional annmnts; s-off wkends is 2300, but is heavily QRM'd by then. (Berg, Conn.) Noted in Calif. w-N-Fr. 0630, fair sig; often has CWQRM. (Balbi)

U.S.A.—Latest sked frn WRUL, New York, is ENG. to EUR.-AFR. 1930-2200 (SAT., SUN. 2215), 17.750, 15.380, 11.790; ENG. to L. AM. 2200-2400, 17.845, 11.830, 15.380, 17.750; Sp. to L. AM. 0000-0300, 17.750, 17.845, 15.380, 11.830. LISTS DXH newscast THIRD SAT. OF MONTH 1945, 2330.

USSR—R. Kiev, Ukrainian SSR, is sked 0130-0330, 11.960, 11.735, 9.665, 9.605; REPEAT 0400-0600, 9.605; all-Ukrainian to N. AM. (Roth, Conn.) R. Tashkent, 11.695, noted w-N-E, "MAILBAG" 1400-1430; SAID also on 9.600. (Pearce, England)

VATICAN—HVJ, 11.740, s-on in lang 0830; noted in Fr. 1145, strg. (Balbi, Calif.) Observed on 7.250 at 2245 w-Sp. religious session. (Saylor, Va.) HVJ, 9.645, hrd opening 0030 in Sp. to L. AM., c-d 0044, parallel 11.740. (Ferguson, N.C.)

VENEZUELA — R. Nacional de Venezuela, Caracas, is AGAIN ACTIVE on 6.170 after an absence of YEARS; hrd w-gud sig 1130-1200. (Legge, Va.)

VIETNAM (NO.) — R. Hanoi, 11.840, noted 1135 w-native-type prgm, fair level in Va. (Saylor) ENG. is sked 0200-0230, 0830-0930 (dictation-speed N-E), N-E 1330-1400 on 11.840, 9.840; ALL MAIL TO HAOI "MUST" BE SENT VIA R. PEKING. (Roth, Conn.)

VIETNAM (SO.)—Saigon, 9.620, gud in Fr. 1400-1430; ID 1420; went into another lang 1430. (Riggs, Calif.)

DEADLINE—Due to space limitations, please send ONLY your TOP-NOTCH items to REACH ME BY APRIL 17 for the MAY issue. Thanks for your FB cooperation! QRA is Ken Boord, 948 Stewartstown Road, Morgantown, West Virginia, U.S.A. See YOU next month?
... K.B.

SOUTH AFRICA-- ULTIMATE BCB DX

By RAY MOORE

Last month I outlined past reception of South African stations by North American DX enthusiasts. This month my predictions for better things to come from the "dark continent."

I believe there will be many instances of South African reception within the next five years, possibly this next fall, and in particular on the east coast. Experience with South African reception on frequencies that border medium waves, such as the 80 meter amateur band, indicate a peak in reception should occur between 2100 and 2300 EST. The commercial service of the SABC, "Springbok Radio" operates on a schedule of 2200-1700 EST weekdays. A Swedish DXer reported in the June 18, 1960 issue of the National Radio Club bulletin "Springbok Radio" was then running from 1700 to 2200 EST on Friday nights and he has heard the program from 1900 to 2000 EST on 1286, 1268 and 1178 kc., in English and Afrikaans.

Therefore I would list the following as "best bets" for anyone wanting to give a try to South Africa reception.

Time—2200-2230 EST weekdays.

Season—September through October, February through April.

Other stations which carry the commercial service are:

575 kc.	10 KW.	Johannesburg
728 kc.	10 KW.	Capetown
782 kc.	—	Bloemfontein
800 kc.	5 KW.	Durban
809 kc.	10 KW.	Grahamstown
845 kc.	10 KW.	Pietermaritzburg
908 kc.	2 KW.	East London
962 kc.	.6 KW.	Kimberley
989 kc.	5 KW.	Pietersburg

Horizons Publications is extremely interested in hearing from any medium wave DX fans who have reason to believe they have logged a South African station . . . as after all, it is THE ULTIMATE BCB DX!

THE WORLD OF DX

(Continued from page 27)

been active in all phases of management for the past decade. Hallicrafters, incidentally, will have two real bang-up surprises for the shortwave listener set in the next six months. We would love to tell you about them . . . but can't just yet!

JONES LOG

. . . We Like it!

Vane Jones, long-time editor-publisher of the "Jones Radio Log" has a brand new edition out. We like it so much that we heartily recommend it be on your shack bench before the month is out. Log consists of all AM, FM, and TV stations in North America, broken down

by frequency, call letters, states and so on. Included is the first FM listing by frequency. Price is \$1.00 from Vane A. Jones Co., 3749 N. Keystone Avenue, Indianapolis 18, Indiana. Frankly, you can't afford to be without it!

NEW KNIGHT RECEIVER

. . . Kit Model R-55

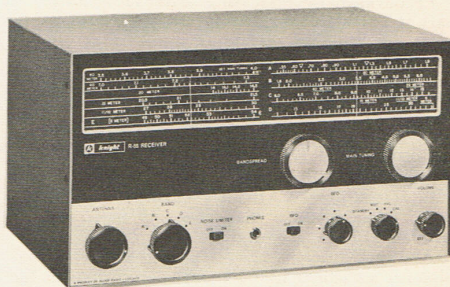

Coverage from 530 kc. to 36 mc. and 47-54 mc. is provided in the new Knight-kit model R-55 "do it yourself" receiver package. Receiver features budget price (\$67.50), selective super het circuit, two IF stages, and electrical bandspread on amateur bands from 80 to 6 meters. Also included—BFO with adjustable pitch, AVC, noise limiter and much more. As will all Knight-Kits the unit comes complete with wall mounting construction diagrams and even the solder. WE DO RECOMMEND IT . . . although we don't see how Allied can put it out for just \$67.50. (Contact Allied at 100 N. Western Avenue, Chicago 80, Illinois.)

MEDIUM WAVE HORIZONS

(Continued from page 29)

PACIFIC

- 625 Costa Rica — TIDCR "R. Internacional de Costa Rica" s-off 0204 3-11. (Robinson)
- 850 Alaska—KICY, Nome, s-on 1200 with India QRM. (Robinson, N.Z.)
- 1007 Greece—Corfu at very good strength arnd 1330 daily. (Robinson)
- 1000 New Zealand—1ZD, Tauranga, 10 kw. took the air on RS 2-25, uses same XR site as 1YZ-800. (Robinson)
- 1020 Tonga—ZCO, Nuku'alofa testing most mornings to 0300. Verie in via air from R. G. Hagggett, Manager, Tonga Broadcasting Comm. (Robinson)
- 1223 Bulgaria—Stara Zagora hrd most days 1330-1400. (Robinson)
- 1322 East Germany—Leipzig hrd w-Moscow relay in German 1300. (Robinson)
- 1304 Poland — Szczecin logged 1245, also hrd Krakow-1502 at same time. (Robinson)
- 1511 Belgium—Brussels III hrd w-nx in Flemish 1300. Included excerpts from President Kennedy's news conference in English. (Robinson)
- 1511 Greece—Chania logged under and over Brussels at same time. (Robinson)

TRANSLATOR TOPICS

(Continued from page 19)

mally the Commission will OK the experimentation for a period of ten days, or so, and if instructed advise you of your authority to conduct antenna tests (or whatever) by return-collect telegram.

TRANSLATOR ACTIVITY SPREADING

... Three New States!

Encouraged by increasing sales activity on the part of Translator manufacturers, Translator applicants are filing in increasing numbers across the nation. During the month of March "initial applications" were filed in three states where no known VHF Translator activity had previously been recorded.

In Missouri the City of Cabool has filed for a channel 6 VHF unit with an ERP of two watts to repeat KTTS Springfield.

In Mississippi WABG-TV channel 6 in Greenwood has filed for a channel 9 unit in Greenville with an ERP of 12.26 watts.

And in Connecticut WNHB-TV, channel 30 has filed for a channel 12 VHF Translator to cover the city of New Haven. Unit would operate with an ERP of 5.4 watts. This is the first example of a UHF broadcaster filing for a VHF Translator.

Broadcaster entry into the VHF Translator field continues. KHSL-TV channel 12 in Chico, California has filed for a channel 2 VHF Translator in Weaverville, California.

TRANSLATOR CONFERENCE

(Continued from page 18)

vision." In his 15 minute address the founder of *Blonder-Tongue* pointed out "VHF Translators must be recognized as only an interim device in light of FCC interest in the UHF spectrum." Mr. Blonder was quick to point out that "within the conceivable future" the fringe area will not disappear, but rather it will grow before it shrinks.

Following the keynote address your editor made a bold prediction that within the next ten years, *the allocations picture willing, the FCC willing, and the manufacturers willing*, this nation may well see 10,000 Translators in service! This immediately drew response from broadcasters in attendance (see photo, page 7).

Special thanks go to Mr. Allen Cordon and Harold Kelly, of the FCC—Washington. Cordon is in charge of Translator applications, while Kelly spends considerable time with type acceptance procedures.

Both Messrs. Kelly and Cordon asked *Horizons Publications* to pass along their gratitude and thanks to the Translator operators in attendance for the fine cooperation. Not quite convinced they wouldn't be lynched when they arrived, both went home confident the FCC had won many new friends and perhaps even "influenced a few people."

EITEL ELECTRONICS

PRESCOTT, ARIZONA

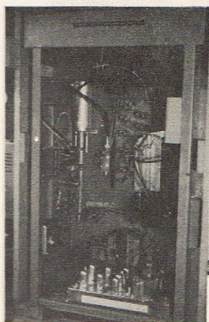

UHF-TR-10 20 WATT TRANSLATOR

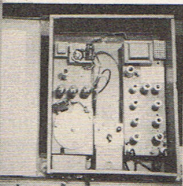

VHF-TR-10/1 TRANSLATOR

Specializing in UHF and VHF, Manufacturing Translators and All Associated Equipment, Antennas, Preamplifiers, Converters—UHF and VHF

EITEL UHF-TR-10 TRANSLATOR \$2,500
EITEL UHF-TR-100 TRANSLATOR \$5,500
EITEL UHF-PA-100 FINAL AMPLIFIER \$3,800
UHF-CL-4A UNIVERSAL ANTENNA—Each . . . \$ 200

The smallest and most efficient—complete VHF Translator!
EITEL VHF-TR-10/1, w/APC \$1,000

EITEL ELECTRONICS

PRESCOTT, ARIZONA

P. O. BOX 830

PHONE HI 5-0691



KNOWN AS MR. BENCO to literally hundreds of users of Benco, Ltd. (Toronto, Canada) equipment, Les Farey was one of our favorite new acquaintances at the Salt Lake "Western Translator Conference." Les personally supervised all of the Cable TV installations in western Canada for Benco in years past, and is now Director of Sales for Video Utility Company in Seattle. —R.B.C.

DON'T Be The Weakest Link in the TV Network!

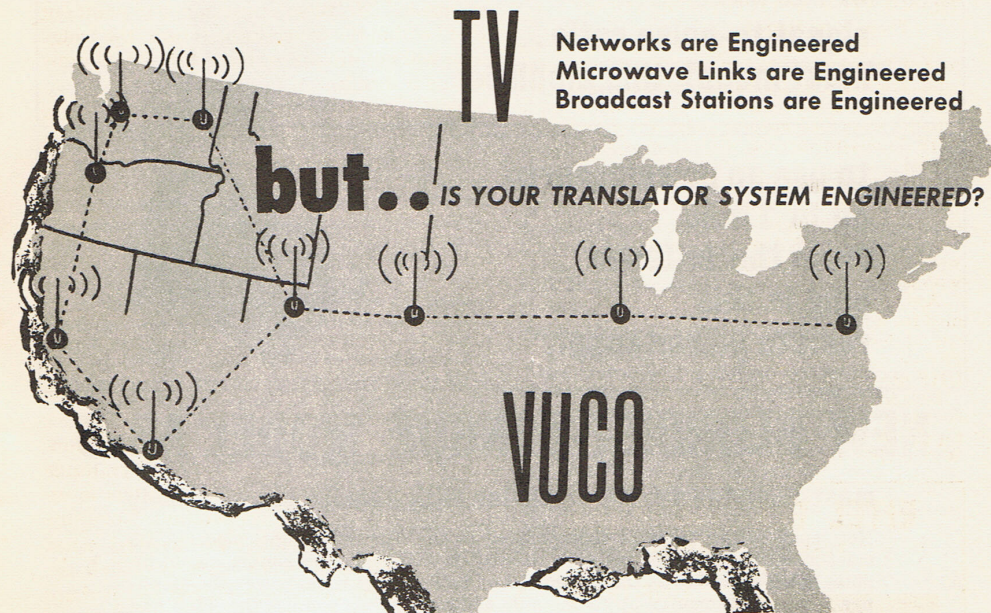

Let's make Translators a STRONG LINK in the TV Network

Call or Write Before June 1st!

Complete Field Survey Assures

- ★ Proper Site Selection
- ★ Improved Signal Reception
- ★ Maximum Signal Reception
- ★ Broadcast Quality Reception

VIDEO UTILITY CO. Has the answers plus

THE PRICELESS EXTRA OF EXPERIENCE

Community
Education
Industry

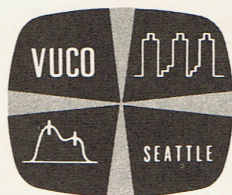

2444 Market St. • Seattle 7, Washington • SUnset 4-1111
Dedicated to the Advancement of Low Power Television

to take advantage
of the best
signal-to-noise ratio ...
mast mount this amplifier



AB-3

to use ac power source
up to 1 mile
from the antenna...
plug in this
remote power supply



RP-3

NEW BLONDER-TONGUE MODEL AB-3

mast-mounted TV/FM amplifier with remote power supply

New engineering features incorporated in the Blonder-Tongue model AB-3 mast-mounted amplifier make it possible to utilize the maximum signal-to-noise ratio available at the antenna, and at the same time, power the amplifier from an AC source up to one mile away. Whether you use the AB-3 and its remote control power supply (RP-3) in a fringe area home installation, or as a pre-amplifier in a master TV system—by locating the amplifier close to the antenna, you take advantage of the best available signal with noise picked up by the down lead minimized.

The remote power supply sends AC power up to the mast mounted amplifier on the same down-lead that carries the antenna signal down. What's more, the remote power supply provides the correct power to the amplifier for any length of connecting cable up to one mile (when open twin-lead is used.) The RP-3 also serves to isolate the antenna signal from the AC and to provide an excellent impedance match for either 75 ohm or 300 ohm cable. This new amplifier employing a low noise frame-grid tube provides 22db (almost 13X) gain on VHF-TV and FM stations.

other features include:

MAINTENANCE FREE OPERATION — Matched remote power supply provides correct voltage for any length of down-lead, assuring longer tube-life.

EASY INSTALLATION WITH 300 OHM TWINLEAD OR 75 OHM COAX—Stripless terminals for 300 ohm twinlead; solderless "quick-disconnect" terminals for 75 ohm coax. No balun is needed because the input is matched to 300 ohm antennas.

CHOICE OF MANUAL OR AUTOMATIC OFF/ON SWITCH — Turns AB-3 on and off automatically when used with most TV sets.

Model AB-3 (including RP-3 remote power supply) **\$104.50.**

Available through distributors.

Free System Layout Aid Available For Master System Installations. Write Dept. HC.

engineered and manufactured by

BLONDER-TONGUE

9 Alling St., Newark, N. J.

Canadian Div.: Benco Television Assoc., Ltd., Toronto, Ont. Export: Morhan Export Corp., New York 13, N. Y.
home TV Accessories • UHF converters • master TV systems • FM-AM radios

CHANNEL 1

(Continued from page 1)

trict' laws. The laws, in many varied forms, would allow local Translators (VHF or UHF) to maintain their installations (and in some instances pay for the installations) through tax monies raised through local assessments. A special report to *Television Horizons'* readers is planned on the subject for May.

OREGON BROADCASTER TO TAKE OVER TRANSLATOR OPERATIONS

... Servicing and Maintenance

In an informal agreement yet to be ratified by the Board of Directors of both corporations involved, an Oregon broadcaster and the motivating force behind a series of northeastern Oregon UHF Translators agreed during the Salt Lake City "Western Translator Conference" to put the future maintenance and servicing of a series of Translators under the auspices of the broadcaster. Under the agreement the broadcaster will install a series of "relay UHF units" to feed the signal from his present coverage area into the now isolated northeastern region of Oregon. Translators will operate using the broadcaster's signal, and all future maintenance will be done by the broadcaster. None of the UHF units now use the signals of the broadcaster involved... some switching and soul searching is bound to result.

EDUCATIONAL TV FOR EVERY STATE

... Zimmerman in Washington

Mort Zimmerman, President of the Electron Corporation (Dallas) told a Senate Interstate and Foreign Commerce Communications sub-committee "each state in the union can install 20 educational television stations by matching dollar for dollar federal grants of \$1,000,000 per state if Senate Bill 205 is passed."

Zimmerman, pioneer and well healed expert on the subject of low power telecasting operations, told the sub-committee a complete educational television station can be installed for \$100,000. He cited the successful operation of Richardson, Texas educational low power outlet KRET-23 which has been telecasting five hours per day for 16 months as proof of his statements.

SALT LAKE TRANSLATOR CONFERENCE

... a Huge Success!

Apparently everyone in attendance at the Salt Lake City Horizons Publications sponsored "Western Translator Conference" went home well pleased with the entire affair. Reports filtering back to this office range from "the show put us in business in a big way" to "we never learned so much about ANYTHING in two days."

Conference was attended by 240 paid enthusiasts representing 24 states, Canada (see full report page 6). Horizons Publications is already making plans for '62 with a full scale Conference covering all phases of Translators (UHF and VHF) and low power origination television. It looks like Salt Lake will get the nod once again... but during a warmer period of year!

BENCO ANNOUNCES "SUPER LOW NOISE PRE-AMP"

... We Like It!

Benco TV Ltd. of Toronto appears to be heading in the right direction with all channel TV pre-amplifiers. Company has just announced the model

PA-LN unit which boasts the G.E. 7077 ceramic triode in the front end. Use of the military and missile type tube gives a net noise figure of "not more than 3 db on the low band (2-6) and not more than 4 db on the high band (7-13)." 7077 is backed up with a single 6DJ8 (6922 type) and five type EF95s. Gain is listed as "66 db minimum." Input and output matches 75 ohm lines and output will vary less than 3 db with a 20 db input variation, with inputs of 50 to 1000 uV.

TV PIX NAMED TO HANDLE EMCEE

... Fiberglass Shelter Too!

TV PIX, Inc. of 179 Social Hall Avenue, Salt Lake City, has been named as exclusive intermountain distributors for the EMCEE line of Television Translators. With the announcement by Dr. B. W. St. Clair, President of EMCEE during the Western Translator Conference, came a further disclosure that Garr N. Johnson will serve as Sales Engineer for eastern and central Utah and McKay Larson of Dixie TV Service Company will handle EMCEE engineering in southern Utah and western Nevada.

ZENITH TO GO TRI-GUN ROUTE

... Color TV in Fall

Zenith Radio Corporation will introduce a line of "completely new and unique color receivers this fall" according to a recent announcement by Hugh Robertson, Board Chairman for the Corporation.

Complete details of the "unique approach" will not be unveiled until the sets are ready for distributor showing late this summer. Zenith receivers have long been favorites of deep fringe viewers who have discovered the line consistently produces better pictures than many competitor brands.

JERROLD APPOINTS NEW SALES MANAGER

... Robert H. Beisswenger

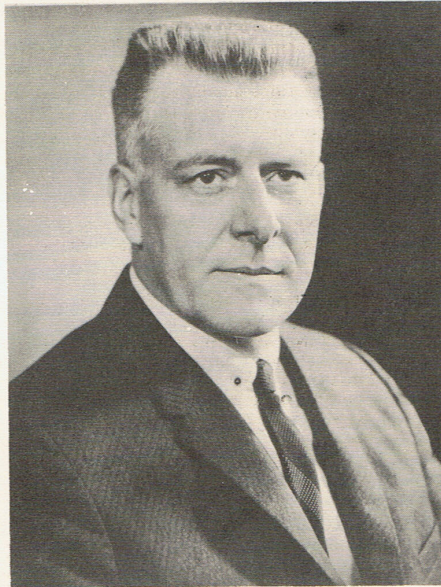

Milton J. Shapp, President of the Philadelphia housed Jerrold Electronics Corporation has an-

nounced the appointment of Robert H. Beisswenger as new General Sales Manager. Beisswenger will coordinate the four expanding sales divisions, which include marketing to industry, government, educational and industrial communications, and cable TV companies and installation firms.

Beisswenger was formerly Vice-President and General Sales Manager of Whitney Blake Company (New Haven, Connecticut) a firm specializing in telephone and power cables.

A BALUN IS A BALUN IS A BALUN

... Opps!

Reference is made to March DXing Horizons page 5, under the article entitled "Corner Reflector Transmitting Antenna ... for VHF Translators." Paragraph two, page five, mentions diagram three, a balun for transforming 300 ohm impedance lines to the vicinity of 75 ohms. The diagram was not printed. It appears below for your edification.

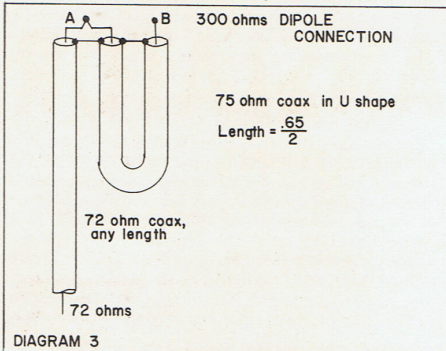

Our thanks to numerous individuals, including Ed Schultz of Estes Park, Colorado.

CANADIAN BBG GRANTS MORE TRANSLATORS

... More Work for Benco

The Canadian Board of Broadcast Governors held its 17th public hearing February 22 to 24 in Ottawa and announced approval of the following Translator and satellite TV station applications:

SALMON ARM, B.C.—Okanagan Valley TV, 5 watts on channel 5 to repeat CHBC-TV, Kelowna, B.C.

EASTEND, SASK.—CFJB-TV, 5 watts on channel 2 to repeat CFJB, Swift Current, Sask.

VAL MARIE, SASK.—CJFB-TV, 5 watts on channel 2 to repeat CJFB, Swift Current, Sask.

CARLYLE LAKE, SASK.—CKOS-TV, 5 watts on channel 7 to repeat CKOS, Yorktown, Sask.

EDMUSTON, N.B.—Lwr St. Law. Radio Ltd, 715 watts on channel 13 to repeat CJBR-Rimouski, P.Q.

HARRISON BROOK, P.Q.—Moncton Bcst. Ltd, 865 watts on channel 7 to repeat CKAM-TV.

Bon Accord, N.B.—CHSJ-TV, 54.7 kw. on channel 6 to repeat CHSJ-TV.

FM Station Power Increase—CHFI-FM received approval to increase its ERP from 9.4 kw. to 210 kw. on 98.1 mc.

PEMBINA KCND-TV RECEIVES REPRIEVE ... in Winnipeg

KCND-TV, channel 12 Pembina, North Dakota puts a fair signal into Winnipeg, Manitoba. Recently CKY-AM Winnipeg applied for use of frequency 103.1 mc. for a 72 kw. FM station.

FM transmitters are notorious for their second harmonics within a ten mile radius of the FM transmitter. The CKY-FM application was turned down by the BBG following a landslide of mail from Winnipeg TV viewers who feared the CKY-FM second harmonic would wipe out KCND in downtown Winnipeg. In turning down the CKY-FM application BBG stated "it is important that it should be clearly understood by all concerned that ... this not be interpreted ... as Canada relinquishing its rights to use of channel 276 (FM 98.1) in the general area of Winnipeg ... at any time in the future."

SHERIDAN WILL CONTINUE

... Special Assistant to Minow

James B. Sheridan will continue as a Special Assistant to the Chairman of the FCC, a post he has held since April, 1960, when Commissioner Ford was at the helm. Sheridan has been reported responsible for a good deal of Comm. Ford's thinking in the CATV field and he spent considerable time touring the western states in 1960 gathering first hand knowledge of western TV reception problems.

BROADCASTER AWARENESS OF TRANSLATORS

... Confidential Memo

A memo dated March 14 from the head of the engineering department to a chain of TV broadcasting station engineers (under common ownership) had considerable to say about his reactions to the Western Translator Conference, which he attended.

Wrote the engineer "The amount of Translator and booster activity in the west is quite phenomenal ... estimates are for the number of Translators to increase to around 10,000 in a matter of years. The (SLC) meeting was well attended by both broadcasters and individuals responsible for the operation of these Translators ... apparently the Commission intends to license these quite freely and in my opinion a multitude of VHF boosters on the air could some day cause havoc with reception in many areas. As a matter of fact, I view it almost like the monster created by Citizens' band radio."

The CE notes "Certainly it (Translator activity) bears watching because through this system other stations are capable of encroaching on what is rightly our coverage area."

About Cable TV the CE concludes "I believe the best way to fight off the cables is to provide free reception through the use of Translators."

WEAK SIGNAL BOX SCORE

"Status of Operating Systems, Units"

To March 25, 1961

VHF TRANSLATORS	
Licensed (on the air)	1
CP's Pending (346 filed)	185
STA (on the air—347 filed)	879
Illegal—Operating	207
UHF TRANSLATORS	
Licensed (on the air)	396
CP's Pending (346 filed)	32
CP's Outstanding	41
CABLE TV	
U.S.—Systems Operating	1140
U.S.—Systems Under Construction	41
Canada—Systems Operating	232
Canada—Systems Under Construction	9

TITANCO

RUGGEDIZED YAGIS

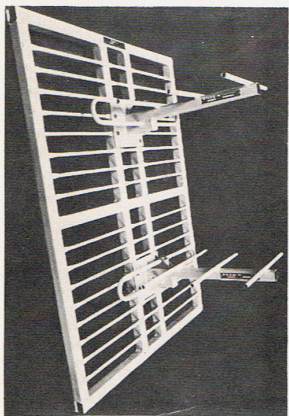

Multiple ruggedized yagi array mounted on screen reflector for maximum front-to-back ratio.

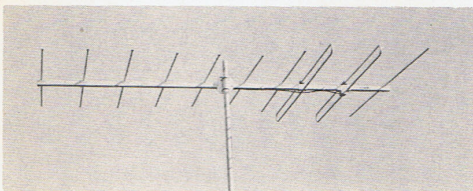

High gain ruggedized yagi with twin-driven elements. Taco yagis pay for themselves after the first storm . . .

EXTRA RELIABLE

HIGH GAIN FOR

TRANSLATOR

OPERATIONS

All-Welded Aluminum Ruggedized yagis available for all TV channel frequencies. Built-in balun assures optimum impedance match for maximum transfer of energy from antenna to transmission line. Double-section construction at all vital points minimizes crystallization of aluminum which usually results from resonant vibrations.

Available in 4, 5, or 10 element designs with dipole or screen reflector. Also, single or multiple driven elements. Standard coaxial connector termination. All types of mounting hardware available.

WRITE FOR CATALOG . . .

TITANCO

TECHNICAL APPLIANCE CORPORATION
SHERBURNE, NEW YORK.

HORIZONS UNLIMITED*

CATV BUYERS

CATV OWNERS

You Reach the Widest Range of Prospects through

DANIELS & ASSOCIATES, Inc.

PIONEER CATV BROKERS

EXCLUSIVE CATV BROKERS

BUYERS

- Let us show you investments with three to five years short term complete return of capital.
- Be on the ground floor for the expanding future in CABLE TELEVISION.
- Check with us for appraisals of existing systems.
- Let us outline an investment program in the field of CABLE TELEVISION.
- Management is no problem with our system of personnel selection and recommendation.

OWNERS

- Capital gains is often the only answer to depreciation problems.
- In selling you must contact the broadest possible market to obtain the best price.
- You gain the best advantage before selling by obtaining the appraisal of independent experts.
- Our job . . . to find buyers of competent ability and financial responsibility.

For discreet representation, sound advice and quick results — contact the CATV authority recognized throughout the United States and Canada. More than 90% of the CATV system sales to date, have been handled by DANIELS & ASSOCIATES, Inc.

DANIELS & ASSOCIATES, Inc.

BILL DANIELS CARL WILLIAMS ALAN HARMON FRED METCALF
The Daniels Building, 3rd Avenue and Milwaukee, Denver 6, Colo., Dudley 8-5888
Canadian Headquarters — — — 31 Quebec Street, Guelph, Ontario, TAylor 2-2030

**Number six of a series. Massive experimental horn antenna during installation at the Florence Shoals, Alabama CATV system. This antenna, still in operation today, was designed for maximum rejection of co-channel interference in a region of the United States where overlapping signal areas cause frequent reception problems.*