

HAND ASSEMBLED No. ONE  
2-60 (1-25-60 - 1:55pm) (2)

FEBRUARY 1960  
40 CENTS

**TV-FM**

# **DXing HORIZONS**



**30 FOOT PARABOLIC DISH AT NORTH BAY, ONTARIO**

VOLUME ONE

NUMBER TWO

**Late News of VHF Booster-Translators!**

PAGE 3

# Attention . . .

## MANUFACTURERS-DISTRIBUTORS

1. of weak signal Television-FM equipment
2. of master TV system, re-radiation systems
3. of shortwave receivers, antennas, parts and assemblies.

Your advertising message in these pages reaches 600 community TV system operators, several hundred present and potential operators of UHF translators, nearly 1,000 operators of VHF booster-repeaters, more than 500 U.S. and Canadian television stations, and TV DX enthusiasts numbering in excess of 4,000 . . . and GROWING.

## Plus . . . From March On

Your message in these pages will reach an estimated 5-10,000 shortwave listening enthusiasts, and be read by the operators of 850 of the world's outstanding international shortwave broadcasting stations.

***Your Advertising-Sales Message on These Pages  
is Your Best Guarantee of Reaching Your Market in 1960***

DXing HORIZONS . . . Controlled and paid circulation only . . . No give away magazines. Full rate card on request.

No. of Insertions: (per 12 months)

Insertion Size	1	6	12
1/8 Page	\$ 25.00	\$ 20.00	\$ 17.50
1/4 Page	45.00	35.00	30.00
1/2 Page	70.00	60.00	50.00
1 Page	120.00	100.00	80.00
Center Spread (two pages) plus Bonus 2/3 of Outside Back Cover, above			
Addressing Area	300.00	250.00	220.00
Inside Front Cover	165.00	140.00	120.00
Inside Back Cover	165.00	140.00	120.00

**DXing HORIZONS, Post Office Box 3150, Modesto, California, U.S.A.**

## At Sign Off

### SQUEEZE PLAY ALONG THE BORDER

With the American FCC taking a close look at minimum mileage separations for stations operating on the same channel, it is interesting to see Canada's Department of Transport (Canadian version FCC) thinking along similar lines, and even proposing to act . . . probably before our bureaucracy gets the muddle straightened out. The facts are clear; neither the DOT or FCC want to allow licensed stations to become dominant on any given channel. Because of the nature of wave propagation at VHF and UHF frequencies, they would rather see low power booster or "Filler Stations" operating in the dead spots VHF stations are not covering with Grade A or B signals. There are many towns along the southern border of Canada which are receiving at least Grade B service from U.S. stations but are not within range of Canadian stations. This is a matter of national pride . . . and the DOT feels the Canadians should be watching Canadian programs. So the DOT proposes to reduce mileage separations along the Canadian-U.S. border. And they plan to shift some of the present allocations. Right off the bat a shift will leave Ottawa without an additional channel for a private station (CBOT, CBOFT there now). Here is what the DOT proposes to do:

1. Cut minimum co-channel separations from 220 miles (present standards in Canada) to 190 miles on 2-6, and 187 miles on 7-13.
2. Allow additional assignments for mileage separations even less than these IF antenna height and power of one station (or both) is cut back. (For instance . . . a one KW station could locate within 120 miles of another one KW job.)
3. Protect existing stations to their grade B contours (100 Mu low band, 220 Mu high band).
4. Change adjacent channels spacing according to a new formula (not yet released).

While these changes would not create a great deal of new TV activity in Canada overnight, it would allow a large number of new station applicants to appear before the DOT for hearings. While these are Canadian proposals, the DOT is morally bound to solicit the U.S. FCC approval of the plan since it would have some affect on currently operating, and planned U.S. Stations along the border. Most Canadian broadcasters have been silent so far although some feel this plan the DOT proposes would produce chaotic reception conditions along the International border.

### SWAPING TIME

One huge three-way swap is underway, the ultimate aim of which will give NBC an O and O station (owned and operated) in San Francisco. RKO Teleradio will take NBC's WRCV (AM-TV) Philadelphia in tax free exchange for WNAC (AM-FM-TV) Boston. Then RKO will turn around and buy WRC (AM-FM-TV) Washington (now NBC owned) for reported \$11-12 million. NBC, with only one station gained while losing two, will seek to return to five VHF's owned (maximum limit) by buying into San Francisco. Likely target is KTVU-2, Bay City. Possible side affects . . . Boston

NBC outlet is WBZ; San Francisco NBC outlet is KRON. Could be both cities would have massive affiliation swaps following NBC negotiations.

### FCC COMMISSIONER T. A. CRAVEN SPEAKS FOR UHF

Returning from the recent world-wide Geneva conference on frequency allocations, FCC man Craven said he sees future shift to UHF for all TV in Europe, perhaps in "ten or fifteen years." BBC and other government bodies have expressed great interest in moving all European TV to the ultra highs. In fact Germany (western) has gone one further with a request to move its TV to the 11,700-12,700 megacycle region, claiming they have developed a superior system of TV for this ultra-ultra high range!

### FRENCH MICRO WAVE

Scheduled for June 1960 completion, a new microwave link to bring French language TV programs to NEW — New Carlisle, Quebec, CHAU-TV-5, from CJBR-TV, Rimouski, Quebec. This will be the only French speaking station on Channel 5, from Canada (note E skip fans).

### FM TO SERVE AS RELAY SERVICE

NBC recently announced they are laying groundwork for using FM station affiliates as background medical service to doctor's offices, providing medical bulletins, background music, etc. ABC now says they would like to use FM as a means of criss crossing the country in lieu of expensive interconnecting cable lines (relaying programs from station to station via off the air pick up). ABC says this would be a true "High Fi Network" to serve both hi brow FM listeners, and AM affiliates to the FM outlets.

### AIRBORNE EDUCATIONAL PLANS

#### GIVEN FCC O.K.

Plans are now in the final stages to begin broadcasts from a DC7 Strato Cruiser on UHF Channels 72, 78, 75 and 76 next fall, as the plane circles above Montpelier, Indiana at 23,000 feet. The educational type programs, coming from the studios of the U. of Indiana will be aimed at 13,000 schools and five million students in the five state area. The project is financed by the Ford Foundation and others. The plane will receive broadcasts from U. of I. on Channels 41, 47, 53 and 59, and rebroadcast through four transmitters. From such an altitude, these UHF transmitters should make good DX targets. We will cover this story in detail prior to the September '60 broadcasts.

### FCC "FORMALLY PROPOSES"

#### INTERIM DROP INS

The FCC has asked for comments, prior to February 19, on its proposal to assign VHF channels to several major markets (undesigned as of yet) in the United States where only one or two VHF's are currently operating. The new channels would not meet existing FCC mileage separations. The proposed drop ins (so called because they do not meet mileage separations between stations on the same channel) reportedly will not go in where UHF stations are now operating. The FCC also proposes to reduce adjacent channel separation to 40 miles from the existing 60 mile spacing.

### MAJOR E SKIP SESSION

A series of E skip sessions January 8-11 brought several hours of E skip to many sections of the country, with skip as high as the FM band reported in some instances. Check DXers Report (page 18).

TV-FM

FEBRUARY 1960

# DXing HORIZONS

"A monthly publication devoted to active long range Television-FM enthusiasts throughout the world. Published the second day of each month in Modesto, California. DXing HORIZONS is the copyrighted title registered to Robert B. Cooper, Jr."

"DXing HORIZONS is aimed at the 25,000 long range TV and FM enthusiasts and the 3,000 operators of TV translators, VHF boosters, and master distribution systems throughout the world. Advertising rate card upon request. DXing HORIZONS accepts advertising ONLY from bona fide manufacturers and distributors of new electronic equipment, parts and assemblies. DXing HORIZONS is the only magazine in its field . . . reader acceptance guaranteed."

**DXing HORIZONS**  
P. O. Box 3150  
Modesto, California

Publisher-Editor:  
**Robert B. Cooper, Jr.**  
(Amateur K6EDX)

Circulation Manager:  
Carole Buchanan

FM DX Editor: Bruce F. Elving

Every effort is made to assure the authenticity of material appearing in DXing HORIZONS. The publisher cannot be responsible for inaccuracies which may arise in the normal publishing and editing duties. The staff does make every effort to enforce regulatory measures over editorial content however.

All rights to material in DXing HORIZONS are reserved by the publisher. Reprint permission available on an individual request basis.

## SUBSCRIPTION INFORMATION

### Canadian-U.S.A. Rates:

One Year ..... \$ 4.00  
Two Years ..... 7.00  
Three Years ..... 10.00

**Airmail** — One Year ..... 7.00

### Foreign Rates:

One Year ..... 4.00  
Two Years ..... 7.50

Full subscription information . . .  
back inside cover.

**IN MARCH . . .  
36 PAGES AND SHORTWAVE.**

## FEATURES

Page

PRESS TIME BOOSTER FILINGS . . . . .	3
TALL TOWER TALLY . . . . .	4
70.6 HOURS OF E SKIP . . . . .	7
NORTH BAY PROJECT (Part One) . . . . .	10
FM DXers REPORT (Elving) . . . . .	14
WEAK SIGNAL INDUSTRY . . . . .	15
TV DXers REPORT (Staff) . . . . .	18

## DEPARTMENTS

AT SIGN OFF (Last Minute News) . . . . .	1
INTERNATIONAL DXing HORIZONS . . . . .	19
TECH NOTES . . . . .	22
FCC ANALYZED . . . . .	24
417A BOOSTER . . . . .	24

# Press Time Booster Filing

WASHINGTON, D.C.

The deadline in the FCC Washington office for filing comments on FCC Docket 12116 (proposing to legalize and establish VHF translators) has drawn a multitude of comments as we go to press. Comments reportedly have been filed by nearly two dozen Montana repeater operators, at least two television stations (KXLF, KCPX), the National Community Television Association (NCTA) and the largest booster organization, the Tri-State TV Repeater Association. In the limited space available on this page, DXing HORIZONS summarizes some of the highlights of the petitions filed by the various groups.

## NCTA-REPEATERS O.K. . . . FOR FIVE YEARS

The NCTA went on record as being in favor of VHF repeaters, only because they believe repeaters will continue to operate as they have for the past four to five years. However the cable TV group feels repeaters should be carefully licensed, with a licensing period to last no longer than five years. Then says the NCTA, the cost of the presently operating repeaters will have been justified, and they can be replaced with UHF units, which the NCTA feels is the ultimate answer to the fringe area problem. In their brief filed with the FCC January 11, the NCTA made it clear it is still not on speaking terms with booster operators. This is understandable because mountain state boosters have been known to pick an occupied channel for rebroadcast purposes, causing bad interference to local community antenna installations. In part, the text of the NCTA brief states: "The following recommendations are (accordingly) urged upon the commission:

1. That upon passage of the necessary legislation, the commission accept applications under oath for licenses from all operators of VHF repeater stations IN OPERATION as of the date of adoption of a final report and order in Docket No. 12116, (and) such licenses (are) to identify, in addition to the operator, the location of the repeater, the area and the number of families served.

2. That the commission grant all applications received within a specified time following public notice of the final report and order, and issue licenses for a period of up to five years subject to the following conditions:

- (a) One watt maximum output power.

- (b) That (the operation causes) no electrical interference (exists) to television reception whether by means of CATV systems of standard receiving antennas, or to reception and rebroadcasting by translator of satellite television broadcast stations . . . and subject to the further condition that any (subsequent) interference shall be eliminated immediately or the repeater (unit) shut off.

- (c) The applicant agrees as a condition precedent to obtaining license that it will convert within the five year license period to an approved service (Note: Here the NCTA recommends UHF translators).

3. (Paraphrasing for brevity) No repeaters shall be established after the initial licensing period (suggested period . . . 60 days after law goes into

affect), and any which do come on, shall be considered illegal, and shut down immediately.

4. Persons who attempt to build and operate new units after the regulations become law shall be prosecuted (vigorously).

## SUMMARY

The NCTA brief runs to 31 typed pages, and adequately covers the entire booster question, from the standpoint of the cable operator. The NCTA has taken steps in its brief to point out to the commission the inherent problems involved in the operation of repeaters, including interference (through re-radiation) to CATV systems.

## THE BOOSTER SIDE OF THE STORY

Speaking for 99 Montana boosters, 38 Wyoming boosters, and 25 Idaho boosters, James Beamer, secretary of the Tri-State TV Repeater Association, pointed out strong points in his group's brief, filed January 11th in Washington, D.C.

Tri-State believes a committee should be formed to deal with the booster licensing on an individual basis. The committee should be composed of members of the FCC technical engineering staff and of the TV repeater association. Tri-State asks that all adjacent channel mileage restrictions (currently 60 miles separation for station on adjacent channels) be done away with when issuing licenses to VHF boosters. Tri-State further asks that the question of interference (where a booster station is said to be causing interference to the off air pick up of a station) be solved by limiting boosters to operation outside the 100 microvolt contours of existing stations. (Low and high band) Tri-State says they do not believe signal levels lower than 100 microvolts should be protected from interference.

## POWER LIMITATIONS

Tri-State points out several instances where the one watt power limit would be a definite hardship on the successful operation of a booster unit. One example cited is the Saunders, Arizona booster, running ten watts output, and covering an area of 340 square miles! If this unit had to reduce power to one watt engineers stated it would take four boosters at one watt output to cover the same area. And yet this area is populated by only 80 television receivers.

## REPAIRS

Tri-State agrees with FCC repair proposals, in which the FCC would limit repairs to first and second class license holders. However Tri-State asks that licensed monitors (probably third class license holders) be allowed to change tubes, if no further adjustment of the unit is necessary.

## EQUIPMENT

Tri-State asks that various "brands" of FCC approved equipment be allowed to be inter-mixed, pointing out that some installations require the various features found in different brands of booster-repeater equipment. (The FCC has indicated they will test and pass judgment on equipment to be sold for booster purposes.)

## FCC PROPOSAL

For a complete discourse on the FCC proposal relative to booster-repeaters, see "Weak Signal Industry," page 15 this issue.



Tallest in the World — TV Tower of WGAN-13, Portland, Maine

# Tall Tower Tally

Twice as tall as the Eiffel Tower, 154 feet taller than the Empire State Building, as tall as an 180 story office building . . . that's how tall the world's highest man made structure . . . the WGAN-TV tower, Portland, Maine, stands. 100 acres of land and 4½ miles of guy cable hold its 1,619 foot surface against winds to 150 MPH.

Much has been said by weak signal enthusiasts concerning the use of tall towers by television stations throughout the United States. Since the first 1,000 footer appeared at WHIO, Dayton, tall tower builders and stations alike have worked steadily to push back this magical frontier in the sky. The current king of the tall sticks belongs to New Englander WGAN-13, Portland, Maine. The WGAN tower, completed early this fall, stretches to 1,619 feet, the previous tall topper belonged to KSWB, Roswell, New Mexico. And even the WGAN tower's days as the world's tallest man-made structure (tower or otherwise) is scheduled for a short rein. KFVS-12, Cape Girardeau, Missouri will bring momentary fame to that Southern Missouri town with a 1,676 footer under construction.

How high can towers go? How effective is height? And what are FCC regulations concerning tower height?

Once a station has reached the maximum power, the only way to increase coverage is by increasing the height of the transmitting antenna. But even here the FCC has imposed rules and regulations to limit stations in their quest for greater heights and more coverage area. FCC regulations state that if a station chooses to build a tower above a specified height they must cut back their transmitter power accordingly to compensate for the additional height. Actually antenna height is not measured in height above ground but rather by height above average terrain. The FCC Rules state in part (Section 3.614 Power and Antenna Height Requirements):

(1) In Zone One, on Channels 2-13, inclusive, the maximum powers specified for these channels may be used only with antenna heights not in excess of 1,000 feet above average terrain. Where antenna heights exceeding 1,000 feet above average terrain are used on Channels 2-13, or antenna heights exceeding 2,000 feet above average terrain are used on Chan-

nels 14-83, the maximum power shall be based on the chart designated as figure 3 of Section 3.699. (The chart, not reproduced here, shows decreasing maximum powers as antenna height above average terrain increases.)

Thus there are limitations to practical as well as legal heights. Practical heights can perhaps be judged by the tallest tower currently in the air. In this case the WGAN 1,619 footer. As technical know how and guying practices become more advanced there can be little doubt that TV towers will climb towards the 2,000 foot mark with increasing speed.

In Section 3.614 quoted, The FCC mentions Zone One. The FCC has divided the U.S.A. into three zones, based on various population and air access way surveys. Zone One (see chart one) consists of the most populated regions of the United States, along the southern Great Lakes east to the Atlantic Coast states. The relative flat terrain in such areas make tall towers a natural choice for covering greater and greater fringe areas where more and more people live. But few stations in zone one have chosen to build towers to exceed the 1,000 feet above average terrain level. Those towers above 1,000 feet in Zone One usually are in depressed areas where the base of the tower is below average terrain. In some cases (such as the Empire State Building and the New York City stations) the advantage of a natural location for the antennas far outweighs the cutback in ERP necessary to meet FCC rules for the added height. Outside Zone One, or throughout the rest of the U.S.A., antennas may reach 2,000 feet above average terrain before power cutbacks are necessary. The FCC feels that with population spread thinner in the South, Midwest and West, tall antennas should be encouraged in these areas.

DXing HORIZONS is extremely interested in receiving reports of the quality of reception from weak signal enthusiasts 200 miles or more from any of the stations listed in chart two. To be of special value, such reports should include a comparison with other stations from the same area, and how the reception from the

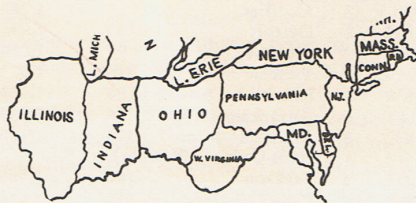

FCC Zone No. One

tall tower(s) compares on a day to day basis with that of the lower tower stations. We are especially interested in comparative reports in reception quality before and after a station went to a new and taller tower. If possible, use standard DXing HORIZONS report forms.

### CHART NUMBER TWO

Stations not exceeding 1,000 feet antenna height above average terrain in Zone One, and not exceeding 2,000 feet above average terrain in Zone Two and Three (all outside Zone One) may use the following maximum values of effective radiated power (ERP.).

Channels 2-6	100 KW
7-13	316 KW
14-83	5000 KW

The following stations have towers in excess of 997 feet.

		KW	Feet			KW	Feet
KCMO	5			Kansas City	100	1,042	
KMBC	9			Kansas City	316	1,042	
KTVO	3			Ottumwa, Iowa	100	1,101	
KMOX	4			St. Louis	100	1,214	
KPLR	11			St. Louis	316	1,214	
KSD	5			St. Louis	100	1,152	
KTVI	2			St. Louis	100	1,048	
KOLN	10			Lincoln	316	999	
WNTA	13			Newark	178	1,200	
KSWS	10			Roswell	316	1,610	
WBEN	4			Buffalo	100	1,001	
WKBW	7			Buffalo	70	1,072	
WABC	7			New York	110	1,465	
WCBS	2			New York	42	1,465	
WNEW	5			New York	37	1,465	
WOR	9			New York	129	1,231	
WPIX	11			New York	100	1,464	
WRCA	4			New York	25	1,465	
WKTV	2			Schenectady	34	1,063	
WSYR	3			Syracuse	100	1,000	
WTEN	10			Albany	144	1,353	
WSOC	9			Charlotte	316	1,073	
WTVD	11			Durham	316	1,503	
WRAL	5			Raleigh	100	1,156	
WECT	6			Wilmington	100	1,000	
KXMC	13			Minot	245	1,053	
KXJB	4			Valley City	100	1,085	
WDAY	6			Fargo	56	1,200	
WHIO	7			Dayton, Ohio	200	1,096	
WSPD	13			Toledo	182	1,045	
WTOL	11			Toledo	191	1,045	
WFMJ	21			Youngstown	94	1,015	
				(UHF)			
KETA	13			Oklahoma City	74	1,572	
KOCO	5			Enid-Okla. City	100	1,356	
KWTV	9			Oklahoma City	316	1,572	
KOED	11			Tulsa	15	1,133	
KOTV	6			Tulsa	100	1,135	
KVOO	2			Tulsa	100	1,176	
KFIL	6			Philadelphia	74	1,116	
WRCV	3			Philadelphia	97	1,116	
WTAE	4			Pittsburg	100	1,066	
WCSC	5			Charleston	100	1,044	
WIS	10			Columbia	296	1,526	
KELO	11			Sioux Falls	316	1,032	
WHBQ	13			Memphis	316	1,073	
WMCT	5			Memphis	100	1,088	
WREC	3			Memphis	100	1,077	
WLAC	5			Nashville	100	1,179	
WSM	4			Nashville	100	1,369	
KTBC	7			Austin	295	1,137	
KRLD	4			Dallas	100	1,521	
WFAA	8			Dallas	300	1,521	
KFJZ	11			Fort Worth	209	1,074	
WBAP	5			Fort Worth	100	1,113	
KHOU	11			Houston	316	1,196	
WOAI	4			San Antonio	100	1,531	
KFDX	3			Wichita Falls	100	1,049	
KSYD	6			Wichita Falls	100	1,000	
WAVY	10			Portsmouth	316	1,026	
WTAR	3			Norfolk	100	1,029	
WCHS	8			Charleston, W. Va.	158	1,000	
WSAZ	3			Charleston	46	1,069	
WFRV	5			Green Bay	93	1,000	
WISC	3			Madison	56	1,107	
WISN	12			Milwaukee	316	1,105	
WITI	6			Milwaukee	100	1,046	
WMVS	10			Milwaukee	129	1,049	
WTMJ	4			Milwaukee	100	1,032	
CFCL	6			Timmins, Ont.	9	1,307	



# 70.6 Hours of E Skip

(DXing HORIZONS looks at propagation . . . part one)

R. E. SMITH  
Radio and Electronics Department  
Provincial Institute of Technology  
Calgary, Alberta

*"R. E. Smith reports on the frequency and strength of summer time E Skip . . . the strange phenomena which sends low band TV signals (Channels 2-6) bounding 500-1500 miles on the earth to be picked up at some distant point by an alert DX fan."*

Radio frequency propagation, using frequencies above 30 megacycles, is not normally possible beyond line-of-sight distances because the ionospheric layers are transparent to these very high frequencies (i.e. radio signals on frequencies above 30 megs usually pass through the E and F layers and continue on into space without being refracted . . . or reflected back to earth at a distant point.)

One mechanism which makes long distance VHF communication possible on occasion is the sporadic ionization of the E layer. This sporadic ionization is designated Es. The occurrence of Es does not seem to bear any relation to the sun spot cycle but it does have a seasonal variation which reaches a maximum in the summer months, a minimum in March and October, with another small maximum in December. MUFs as high as 100 megacycles and higher have been recorded from Es refraction.

As Es occurs at the same height as the normal E layer ionization, skip distances are seldom less than 500 miles or more than 1,500 miles. Low band VHF television stations, using the frequencies between 54 and 88 megacycles and operating on a continuous basis of 18-24 hours per day provide a ready

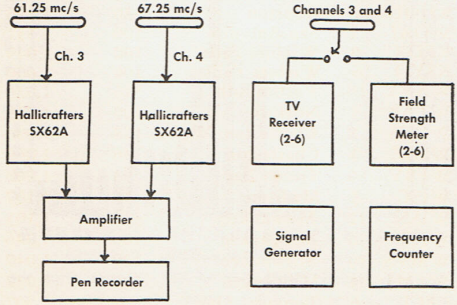

source of signal at the frequencies where Es is of marginal effectiveness. In the light of this, it was thought worthwhile to attempt to obtain some statistical data on the frequency of occurrence of Es, using a system of continuous monitoring of television channels. In the Calgary area Channel 2 could not be used for observation because of a local station. However, surveys indicate there are 18 stations on Channel 3 and 19 stations on Channel 4 within a 500 to 1,500 mile radius of Calgary.

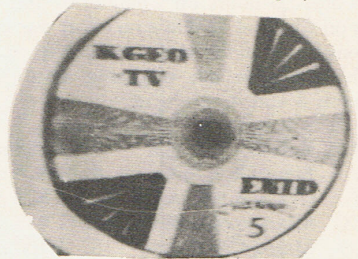

With the MUF riding 82 megs, KGEO-5, Enid Oklahoma, seen in Fresno, Calif. (Cooper) a good grade Es signal.



Es is often marred by co-channel interference from stations on the same channel and by ghosting, both apparent on KOB, Albuquerque. (Barnhart, Illinois)

## EQUIPMENT

Two communications type receivers (SX-62A) were set up and tuned to the carrier frequencies of Channel 3 and 4, which are 61.25 and 67.25 megacycles respectively. The AVC voltage from each receiver was made to operate a pen recorder, after suitable amplification and discrimination against noise, and the short meteor burst type of reflections. Recording sensitivity was reduced to signals in excess of 10 microvolts as further protection against noise. Antennas were of the simple folded dipole and reflector type, to provide a wide azimuth view of the horizon in a southeasterly direction—the area of greatest concentration of TV stations at the frequencies, and distances of interest. A television receiver and field strength meter were also available to provide station identification and signal strength measurements when required. A lab-

oratory signal generator and frequency counter were used to keep the SX-62A's checked for calibration. Figure one depicts the block diagram of the assembled equipment.

### RESULTS

The equipment was first turned on May 28, 1959 and it ran continuously until July 26, 1959, or a total of 60 days (1,440 hours). During this time reception was recorded on 30 of the 60 days (50%) for a total hourly value of 70.6 hours on Channel 3, and 60.2 hours on Channel 4. While no effort was made to identify all of the stations received, it was possible to note the following stations on Channels 3 and 4:

	Channel		
WDAF	Kansas City, Mo.	3	1,238 miles
KTIV	Sioux City, Iowa	4	1,015 miles
WKY	Oklahoma City, Ok.	4	1,332 miles
WCCO	Minneapolis, Minn.	4	1,045 miles
KGLO	Mason City, Iowa	3	1,100 miles
KDAL	Duluth, Minnesota	3	1,015 miles

Figure two indicates the location of the stations received in relation to the position of Calgary.

### CONCLUSIONS

It would be presumptuous indeed to draw any extensive conclusions in the light of such short data, however, it is possible to make some observations based on the trends indicated.

Reception is not of program quality (EDITORS NOTE: Not usually, but any DXer will give you numerous examples of exceptions to this rule!), due mainly to the deep fading rate characteristics of the signal. The fading rate varies over a wide range which may be a few seconds or several minutes. Signal strengths seldom exceed 250 Microvolts and were more commonly 40 to 50 Microvolts. (EDITOR'S NOTE: The signal strengths quoted here were developed with the simple dipole and reflector antenna. Signal strengths of several thousand

Microvolts are often reached when large receiving antennas are employed by the DX fan). Frequency selective fading is also prevalent, manifest by ghosting and smearing with the sound signal not always present. The data shown on Figure 4 indicates a definite peak in reception at this location at local noon, with the possibility of some type of reception during most of the 24 hour period.

GHOSTING IN FADING



Smear and ghost on KDLO, Sioux Falls, S.D. during Es. (Wright, Edmons, Washington)



Less smear, more ghost on CKBI, Prince Albert, Sask. (Cooper, California)

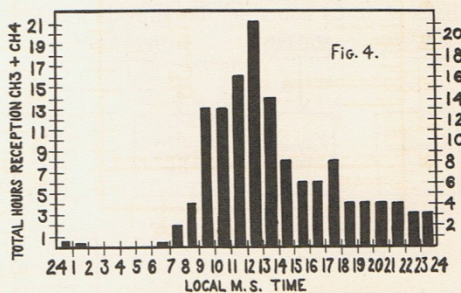
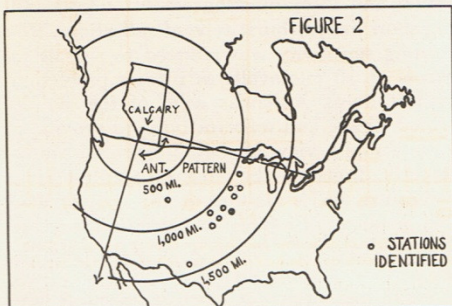

Figure 4: Hourly distribution of all reception from the two channels for the 60 day period.

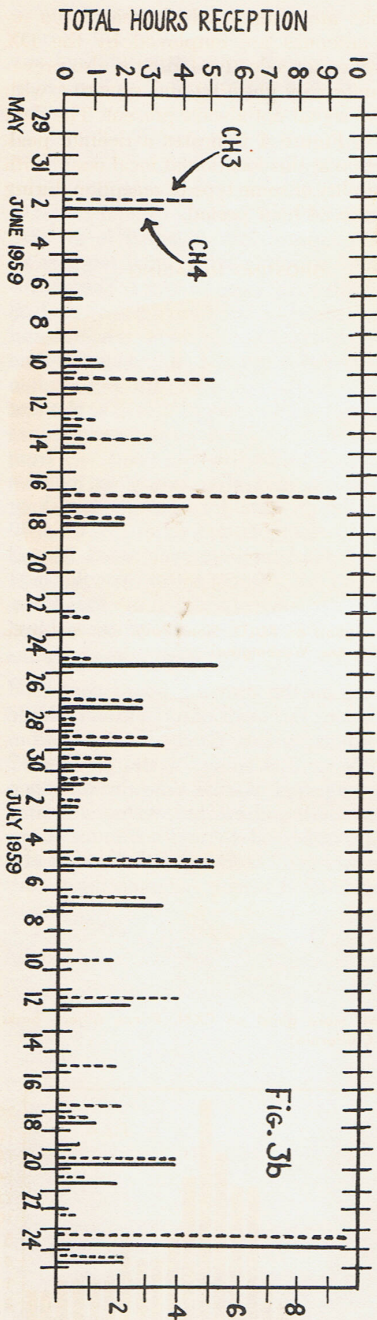

FIGURE 3B: Total hours of reception for each channel (3 and 4) on the dates indicated.

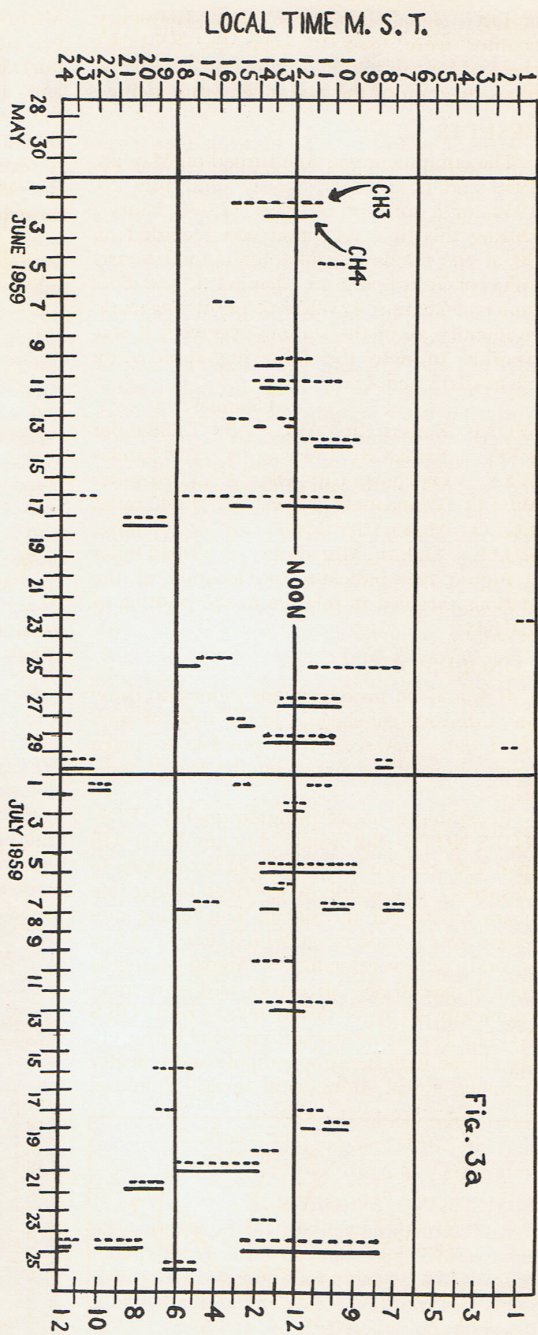

FIGURE 3A: Synopsis of date, time and duration of each recording. Data for Channel 3 appears as a dashed line to the left of the solid line for Channel 4.

# North Bay Project

(Part One)

Meet Stan Hosken, a TV experimenter extraordinaire who needs lots of room for his TV work because his specialty is antennas . . . large antennas. To you or I a large antenna might be stacked ten element channel two yagis. To Hosken, no antenna is large, simply MORE efficient. Weak signal enthusiast Hosken does his building in North Bay, Ontario, Canada. North Bay is nestled on the eastern edge of Lake Nipissing, in the heart of some of Eastern Canada's greatest fishing waters. North Bay is the jumping off point . . . you can go north on combined Canadian Route 11 and 17N to eventually wind around Lake Superior, and land in Duluth; you can go east to Ottawa; you can drive due west to Sault Ste. Marie, or you can head south and back towards more civilized areas . . . and Toronto. The land around North Bay is flat . . . except where it is hilly, and then the hills can be more accurately described as mounds of rock covered with a few inches of sand and gravel. This is North Bay, 300 miles north of the Peace Bridge at Niagara Falls . . . 290 miles due north of Buffalo . . . 290 long miles for a television signal. But the distance didn't stop many of Hosken's less technically equipped but richer neighbors from trying their luck with video in the early spring of 1951 . . . nor did the poor results gained by the hardy few appear to discourage other monied enthusiasts from buying 100 foot towers, a couple of signal amplifiers, and stacking a few yagis for Channel Four. Hosken describes their early results as "distorted sound and a drifting frame bar which would lock long enough to hold a 30 minute program once every fourth day." None of this impressed Hosken, who had little faith in commercial antennas, boosters, and receivers. "All of that gear was built with a 100 mile fringe area in mind" Stan would say, "and this is three times that far." "It is going to take something special to bring TV to North Bay."

## SOMETHING SPECIAL

And something special he built. First he surveyed his land, and decided his 400 foot hill was like having a four hundred foot tower in his back yard. Next he purchased a 100 foot tower, and installed it on the 400 foot hill. For measurement purposes he stacked a couple of commercially built yagis, and fed the output to his Channel Four (WBEN-TV, Buffalo)

field strength meter. The meter barely moved . . . except when a car went by.

So Hosken put some of his wartime learned knowledge with the Canadian Radar Corps to work. "To capture lots of signal in an area where there is only a little signal requires an antenna with a big capture area." This means it must be broad, as well as high . . . and all of this in addition to being super sensitive and directive. Only one type of antenna at the time appeared to fill the bill . . . a yagi. But Hosken had already tried a couple of six element stacked yagis on Channel 4 (commercial ones at that). Back to the drawing board . . . from whence he emerged after nearly six months, with the design data for a single long-long yagi . . . 17 elements on Channel 4, on a 30 foot boom! Hosken built one, tuned it, and erected it on the 100 foot tower. Now his field strength meter showed a signal . . . sometimes as much as 50 Mu, but always something!

## HEART OF THE SYSTEM

As plans on the drawing board continued it was obvious the heart of any antenna, large enough to capture a Grade B signal from WBEN-TV at 290 miles, would be the 17 element long yagi. At the time the first long yagis were built and erected, Antenna Smiths peddling commercial TV and communications antennas were still working with 5 and 6 element yagis. 17 elements (or even the theory

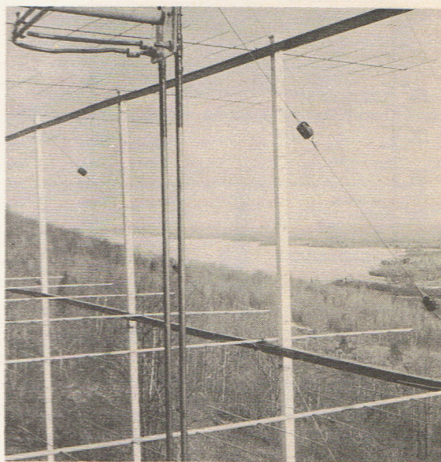

After fruitless attempts to photograph the 276 elements—"D-H" gave up and decided on this shot.

behind long-long yagi design) was still several years in the future. But not to Hosken . . . he was building stack after stack of 17 element yagis until in the end he had 16 of the monsters . . . and with the aid of a catwalk built between six 40-foot towers on the side of his private hill, he erected eight long yagis over eight long yagis . . . for a total of 276 elements! The entire array stands 160 feet long, 30 feet deep and 9 feet high!

#### STACKING—PHASING—GAIN

Stacking of the antennas is done on the basis of three-quarter wave spacing vertically (one stack nine feet above its lower counterpart) and one full wave horizontally. Initially the individual antennas were phased together with 300 OHM line. More recently a coaxial phasing system has been developed, which necessitated the changing of the Dipole feeds from folded Dipole 300 OHMS to straight Dipole 72 OHMS. Because the signal from the antenna is used to feed nearly 900 feet of RG-11 coaxial cable, and due to Hosken's home brew 72 OHM INPUT signal line amplifiers, he finds the system performs better with less smear now he no longer converts the 300 OHM antenna signal down to 72 OHMS through a balun.

#### SCATTER AND GAIN

The signal Hosken receives from WBEN is forward scatter . . . which means he is getting greatly varying amounts of signal at different points on the antenna at any given instant. The signal from WBEN covers a 290 mile path, first across a short length of Lake Ontario, and then over the rolling hillside which becomes progressively steeper as it approaches North Bay. WBEN's Grade B signal drops out 215 miles south of Hosken . . . the last regular spot for WBEN (and other Buffalo) reception used to be Barrie (before CKVR came on Channel 3 there) . . . and Barrie is 165 miles south of North Bay. To be sure the very minute particles of signal which somehow "scatter" into the North Bay region are weak indeed. Basing the gain of a single stack yagi (17 elements) at 15 DB. Hosken watched signal levels on his single stack yagi mounted on the 100 foot tower. After preliminary adjustments the signal seemed to vary either side of fifty microvolts on his meter, which he notes is probably a generous meter. Hosken's original intention was to bring TV to North Bay, via cable. He therefore felt 500 microvolts of signal was needed to insure the level would always be high enough to provide a good quality signal after several miles of cable distribution.

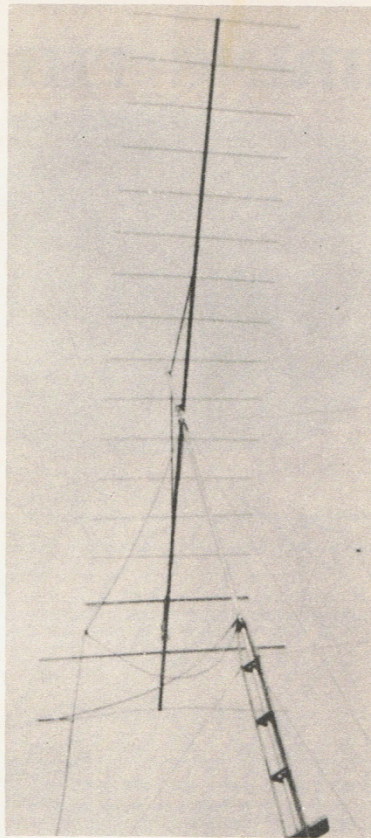

Hosken's 17 element low band (2-6) yagi. 15 db. gain.

To increase the signal level to 500 microvolts from 50, Hosken made his antenna 16 times larger. Today the signal maintains its 500 Mu level during eighty percent of the time in the winter, and ninety percent of the time in the summer!

#### SIGNAL VARIES

The entire array is broken down into two separate arrays of eight yagis each, and each set of eight is fed into a pre amp mounted on the array, before the two sets are tied together. Before initial tests were completed Hosken discovered that by feeding the output of each set of eight into a field strength meter, he could "see" what was happening on each set at a given instant. With the two meters side by side, Hosken says the signal level is seldom the same on both, fluctuating as much as several hundred microvolts over a period of a few seconds (thus helping to substantiate the scatter theory). (continued on page 17)

# BRING THIS SIGNAL

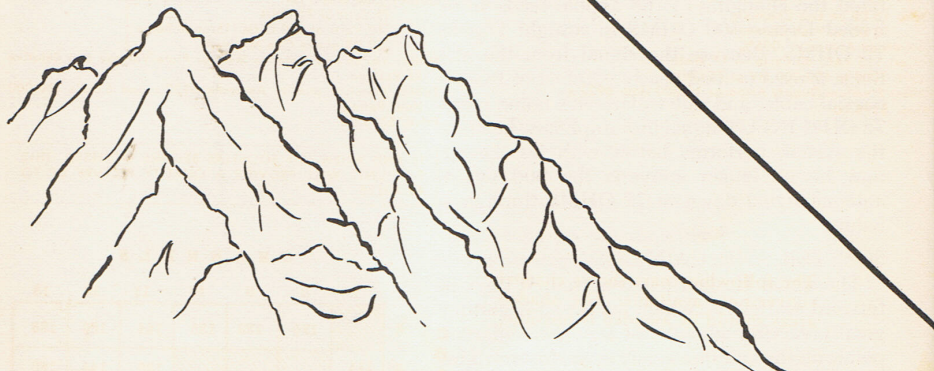
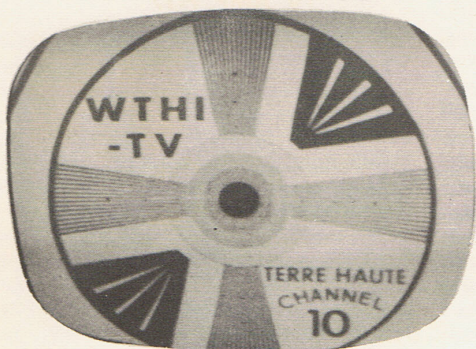

## M.A.R.S. ONE WATT (Plus) AMPLIFIER SYSTEMS

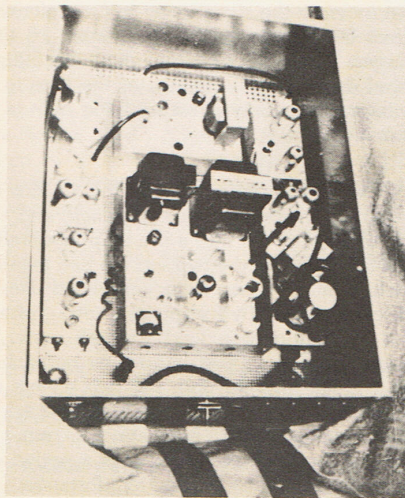

Complete — aligned and assembled. Ready to install on your new system or as a replacement for older systems. A complete high output amplifying system with conversion. The RX-17 uses two BT proven quality MCS amplifiers with M.A.R.S. Converter CX-30 and Metered Final (F-17).

The system is capable of one watt PLUS output with as little as 50 microvolts input.

The unusual range of automatic gain control enables complete pre-adjustment to accommodate ANY useable signal level.

Metered output eliminates guesswork for fast — efficient operation.

### AVERAGE VALUE SPECIFICATIONS:

Gain: 110-120 DB.  
Conversion Accuracy: .005%  
AGC: 40 DB.  
Input Range: 50 Microvolts to 5000 Microvolts  
Output: One Watt Plus  
Power: 115 Volts AC 60 Cycle (140 Watts)  
Cables: Low loss input and output cables and baluns to match 300 OHM line are included.  
Installation: Can be done by anyone in a short day.  
Price: \$957.00

### M.A.R.S. CRYSTAL CONTROLLED CONVERTER CX-30

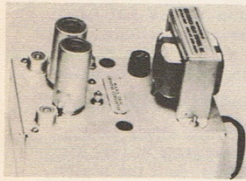

**RELIABILITY . . .**  
The world's most reliable converter-amplifier units, with 10,000 hours tube life in premium quality Amperex 6922 Tubes. The CX-30 is the heart of any amplifier system which requires the highest accuracy in conversion, and maximum reliability. Input may vary from 1,000 Mu to 100,000 Mu at 75 OHMS. One-half of the second 6922 is reserved for possible use with a coding on-off system.

system which requires the highest accuracy in conversion, and maximum reliability. Input may vary from 1,000 Mu to 100,000 Mu at 75 OHMS. One-half of the second 6922 is reserved for possible use with a coding on-off system.

**AVERAGE VALUE SPECIFICATIONS:**

Gain: 15 DB on Low Channels  
10 DB on High Channels  
Conversion Accuracy: .005%  
Power: 115 VAC, 60 Cycle — 17 Watts  
Input: 1000 to 100,000 MV at 75 OHM.  
Tubes: Premium Quality Amperex 10,000 Hour 6922's.  
Price: \$195.00

### M.A.R.S. ONE WATT FINAL TV AMP. F-17

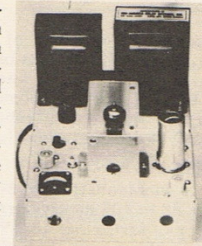

Mountain top locations require the very best in equipment . . . and when you need 10,000 hour reliability, high output, and broadcast quality amplification . . . M.A.R.S. equipment is for you. Maintenance calls are held at the lowest rate in the industry with M.A.R.S. equipment . . . and the F-17 amplifier.

**AVERAGE VALUE SPECIFICATIONS:**

Gain: 26 DB over Each Input  
Band Width: 6 MC (Plus-Minus) One DB.  
Power Requirements: 115 VAC, 60 Cycles, 70 Watts.  
Output: One Watt Plus

9 Volts at 75 OHM  
13 Volts at 300 OHM (Through Balun)  
80 DB above One Millivolt.

Meter: Switch and Meter to Monitor Plate Voltage and Relative RF Voltage.

Tubes: Premium quality Amperex 6922's and 6360's (10,000 Hour Rating)  
Price: \$395.00

IF AND WHEN VHF BOOSTERS BECOME LICENSED, THIS F-17 UNIT WILL PROVIDE A QUALITY PICTURE UP TO 40 MILES.

The following chart shows channel conversions available. The shaded areas should be avoided if possible.

		CHANNELS						
		7	8	9	10	11	12	13
CHANNELS	2		126	132	138	144	150	156
	3	114				138	144	150
	4	108	114	120	126			
	5	98	104	110	116	122	128	134
	6	92	98	104	110	116	122	128
	Trap							

# HERE

with

## M.A.R.S. Amplifier Systems



"Vallytown USA"



**MID AMERICA RELAY SYSTEMS, INC.**

601 Main Street

Rapid City, South Dakota

# FM Reporting

Edited and Prepared by BRUCE ELVING  
920 Laramie Street, Manhattan, Kansas

Due to the newness of this column and this magazine, the FM reports on hand are few.

This cannot be due, I know, to a lack of winter-time FM DX, for FM listeners in Kansas and Oklahoma, at least, have reported significant long-distant FM activity.

## KANSAS DX

Here in Manhattan, non-skip DXing conditions on the 88 to 108 megacycles band were as good the evening of December 16, 1959 as I have ever found them in the winter period. Between 6 P.M. and midnight (CST) on the 16th, FM stations not ordinarily receivable which were heard, ranged from the ten-watt KSTE 88.7 Emporia, Kansas, 57 miles away, to WROK-FM 97.5 Rockford, Illinois at 450 miles. The area of good reception extended across Missouri to include WTAD-FM 99.5 and WGEM-FM 105.1 Quincy, Illinois. Iowa stations heard in Manhattan were KROS-FM 96.1 Clinton, WOC-FM 103.7 Davenport and educational WOIFM 90.1 Ames. Additionally, WHBF-FM 98.9 Rock Island, Illinois was received.

Equipment used in receiving these stations included the Harman Kardon tuner and booster described in the January issue of DXing HORIZONS. The antenna in use in Manhattan is an eight-element Winegard FM, extending ten feet above the floor level of a two-story building, and is manually rotated.

## DULUTH DX

Back in Duluth, Minnesota for the Christmas vacation, DXing conditions were only normal. The best distance was WROK-FM which, strangely enough, was also the most distant station heard in Kansas during the four months I had been in that state. On the average day, such distant stations as WIBA-FM 101.5 Madison, Wisconsin at 285 miles and KGLO-FM 101.1 Mason City, Iowa at 250 miles could be heard.

## VERIFICATIONS

Out of 346 FM stations logged at my Duluth location, 264 have verified. Illinois has been the most productive state with 47 stations heard. Second-place honors go to Wisconsin with 32. The states of Ohio and North Carolina follow closely.

## SUMMER TROPS

On August 18 and 19 last summer, nine new FM stations were added to my Ohio list alone, bolstering Ohio totals to 29 stations logged at Duluth. New stations included WKBN-FM 98.9 Youngstown, WPFB-FM 105.9 Middletown; WHK-FM 100.7, WJW-FM 104.1, KYW-FM 105.7 and WNOB 107.9, all Cleveland; WSOM 105.1 Salem, WEOL-FM 107.3 Elyria and WICA-FM 103.7 Ashtabula.

Ohio was not the only area heard from during that exceptional tropospheric FM reception period. More distant stations included WBEN-FM 102.5 Buffalo, N.Y. at 725 miles from Duluth, WPIC-FM 102.9 Sharon, Pa. and WMGW-FM 100.3 Meadville, Pa. The most distant station, however, was

KDKA-FM 92.9 in Pittsburgh, Pa. at 750 miles. A Detroit station that had eluded my DXing efforts of the previous ten years, WKMh-FM 100.3, was also received.

The only major skip heard last summer by your editor was in the late afternoon of July 23, when my 33rd state on FM was logged, with the addition of WKBR-FM Manchester and WTSV-FM Claremont, New Hampshire. Several stations from Boston were added then, as well as Class A, community stations in Brockton, Mass. and Woonsocket, R.I.

## STATION VERIFICATIONS

Writing to stations that are received is considered a "must" for real DXers. And the replies, especially from FM stations, are often highly interesting. I. B. Robinson, technical director for the Yankee Network and WRKO (FM), reported in 1959 that "Along the lines of sporadic E transmission, some time ago we listened to an educational FM station in San Francisco, here in Boston. Reception was consistent for a week to ten days and at noontime we could hear them sign on the station, although they used comparatively little power." The Yankee Network pioneered in FM broadcasting prior to 1940 and operated a station in Paxton, Mass., "which was monitored consistently at Grand Island, Nebraska." It is likely, however, this reception was achieved on the old 42-mc. band, which was utilized for FM broadcasting prior to 1946.

In addition to acquiring tidbits of information concerning FM DX and learning more about the stations that are received, one can often discover whether or not his report represents the greatest distance a given FM station has been heard. Virtually the majority of my verifications mention that I was the most distant person ever to report reception of their FM station. Of course, it is much easier to elicit such responses if one asks the stations, as I do, if the present report happens to be the most distant one they have received, or if not, from what other distant points they have record of reception of their FM station.

Whether listening for DX, or hearing from the stations through the mails, the long-distance reception enthusiast has in store for himself an endless source of challenge and fascination in FM.

Let us learn of your FM DX efforts by means of a letter addressed to me, DXing HORIZONS FM Editor, in Manhattan, Kansas.

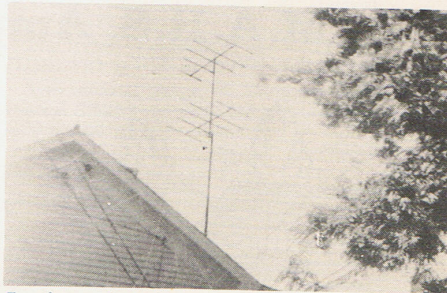

Ten-element Rotatable Yagi at Elving's Duluth home.

Deadline for FM DX reports for March issue is February 12 in Manhattan, Kansas.





## WEAK SIGNAL INDUSTRY

### Green River, Wyoming

As we write these words action is still pending with the FCC on Docket 12116, which proposes to establish and license VHF converter-boosters. In a docket issued in December of 1958, the FCC ruled that all TV repeater stations should be in the UHF band. This docket has met with nothing short of armed rebellion throughout many of the mountain states where illegal VHF booster-repeaters have been in operation since the mid 50's. VHF booster-repeaters take several forms of operation. The most complex involve elaborate antennas mounted high on a peak, feeding the precious microvolts into high gain low noise amplifiers, which in turn feed crystal controlled converter units (changing the channel of the signal). The converter unit usually feeds a low output re-radiation transmitter and a directional high gain antenna re-radiating the amplified and converted (converted away from the direct channel of pick up to avoid problems with feedback between the first amplifier and the low power transmitter) signal into a valley town below.

And the most simple, and unfortunately the most common, is as simple as a TV booster itself. Commercially built signal boosters receive and amplify the signal, and then where they would normally feed the output to a TV receiver, the booster drives a second antenna, designed to radiate this milliwatt power down into a valley location below the mountain top antenna. Usually such systems are plagued with feedback, regeneration, picture smear, and instability. The cost is low, but the results are correspondingly poor.

### DOCKET 12116 PROPOSES CHANGES

The FCC proposes to change the status of licensed repeater stations. Currently only UHF translator devices, which retransmit on one of the upper thirteen UHF channels, are licensed to receive a broadcast signal, amplify and convert it to another channel, and re-radiate it to a small concentrated sheltered TV area. The FCC now proposes to make VHF repeaters legal, provided they fill several definite pre-established engineering rules. The FCC, after

much study and time, apparently feels there is a need for VHF type repeaters. The newly proposed rules (amendments to the communications law . . . Sections 4.701 to 4.784) very briefly says the following:

1. By definition, a television broadcast translator is a station operated SOLELY TO RE-TRANSMIT the signals of a television broadcast station, or another translator, by means of direct frequency conversion and amplification.
2. VHF translators are not required to observe a minimum separation (170 miles plus) of regular licensed broadcasting stations on the same channel. However, translators may not interfere in any way with the reception of a regular station on their chosen channel (thus VHF translators are the SECONDARY OWNERS of their channels).
3. Interference will be considered to occur whenever reception of a regularly used signal is impaired by a translator station.
4. A television broadcast translator station shall not be operated solely for the purpose of relaying signals to one or more fixed receiving points for retransmission, distribution, or further relaying.
5. A translator will be issued to any qualified individual, where a need for such a unit is proved by the applicant.
6. The transmitter power output of a VHF translator shall be limited to one watt peak visual power.
7. An antenna site within five miles of the area to be served is to be selected. The site should be within line of site of the area to be served.
8. The FCC will only consider applications from applicants specifying use of FCC approved equipment, meeting high engineering standards.

In general, the rules and regulations proposed make it clear the FCC does not intend to allow translator stations to originate their own programs, operate in a hap hazard manner likely to produce interference to existing reception, or run excessive power. Additionally the VHF translators (as well as the already established UHF units) must actually receive, convert, and retransmit the signal without altering or degrading it in any way.

### BUT WHAT ABOUT . . .

Green River, Wyoming, a typical western mountain town, is shadowed from TV reception by both surrounding mountains and distance from operating TV stations. The only likely reception for this town on Highway 30 in southwestern Wyoming comes from Salt Lake City. Or it would come from Salt Lake City if the neighboring terrain didn't loom 1,200 to 2,000 feet above the river valley and if Green River wasn't 160 miles northeast of Salt Lake and well "over the horizon." The terrain between Green River and SLC is as rough as you can find anyplace in the country, definitely

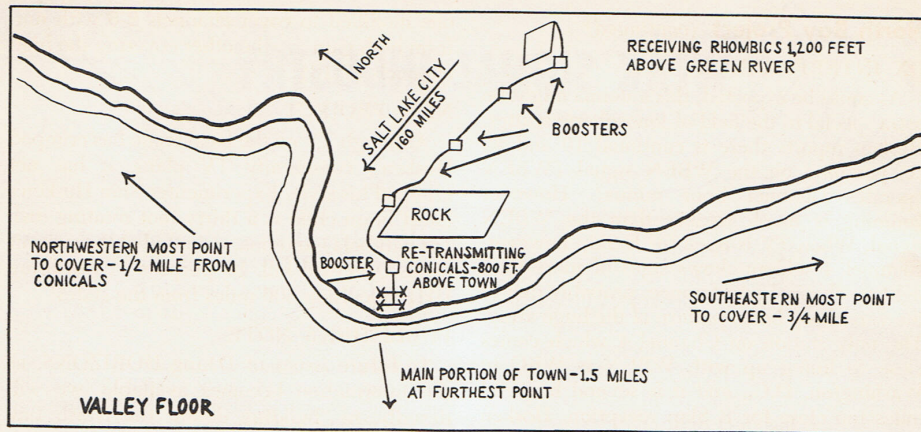

not the type you expect to find 54.82 megacycle signals crossing. But a TV enthusiast group in Green River decided to probe for signal, and on a flat hill 1,200 feet above the town, and to the east above the river, they found fair to good signals from Channels 2, 4 and 5, all in Salt Lake.

The antenna system used for the Green River on channel booster system was a two stack rhombic (Number One), on 60 foot towers. The rhombic was ten wavelengths on a leg, for the highest channel used (Channel 5). Coming out of the rhombic antenna, signal strengths averaged 450 Mu on Channel 5 (KSL), 250 Mu on Channel 4 (KTVT) and 300 Mu on Channel 2 (KUTV). The rhombic antenna was stacked for optimum performance on Channel 2, the weakest of the three channels. The signals were amplified 55 feet from the antenna by a commercial Jerrold Desnower which ran at one-quarter gain. 350 feet of RG9U coaxial cable next carried the signals to a blonder tongue MLA unit, also operated at one-quarter gain. Then as the drawing shows, the signals wound down 200 feet (elevation) by going horizontally one-half mile west to the edge of a cliff overlooking the town. Here another B-T MLA unit amplified the signal, and with milliwatt output, fed 100 feet of RG9U which in turn loaded a set of conical antennas which reradiated the signals over a several square mile area.

#### WHAT... NO FEEDBACK?

From Diagram One, you have decided the boys in Green River must have been geniuses of the first order, because they pointed their rhombic antennas right at the re-transmitting antennas (conicals) and yet they are apparently not getting interaction between the two. No conversion here... all three channels (2, 4, 5) picked up, amplified on channel, and re-radiated. The secret of the stable system — a huge rock... 300 feet high, 300 feet wide, and 300 feet deep... acting as a shield, separating the receiving antennas and re-transmitting antennas, even though the receiving set pointed through the transmitting set. And the receiving rhombics were nearly four hundred feet higher than the transmitting conicals. Rhombic antennas have very little pick up below (or above) their horizontal plane, giving added protection to the feedback problem.

#### ANTENNAS AND MATCHING

The Rhombics were constructed according to standard formulas, from copper clad steel number ten wire. A delta match was used to match the 800 OHM rhombic impedance (at the center of the stacking bars) to 300 OHMS, which matches the Jerrold De-Snower. Open wire transmission line ran the 55 feet between the delta match on the rhombics and the de-snower input. The output of the de-snower had a standard four to one balun matching it to the 72 OHM RG9U. In the output end the 72 OHMS ran through a matching transformer to give the conical transmitting antenna 300 OHMS input. The conical consisted of two stacks, twisted to cover a large semi circle, and stacked at one-quarter wavelength for Channel 2.

#### OTHER ANTENNAS

Yagi antennas were also tried for transmitting, but coverage was too limited. A homebrew turnstile proved to be inadequate because of a poor pattern.

#### WIRED SYSTEMS... SETS COVERED...

##### POOR RECEPTION

With 500 receivers in operation in the town, this is truly a paradise for "ANY" system... there can be NO direct reception... all signals must come via the re-transmitted signal or a cable. Despite the high Mu level present at the rhombic antenna, the system has proved to be anything but adequate, with only fair reception possible on Channel 5 (highest signal level) and fair to poor present on Channels 2 and 4.

During the critical years, 1957-58, no attempt was made by the FCC to close down the Green River re-radiation repeater though it did not meet the requirements of the FCC. As it served such a large area, and was free from feedback problems, the FCC apparently felt it should be allowed to remain on the air until they reached a decision concerning licensing.

#### WITHIN A ONE-QUARTER MILE RADIUS

Reception on Channel 5 is nearly snow-free with good definition up to a point one-quarter mile from the conicals. From that point back to two miles signals become weaker with Channels 2 and 4 fading. On some of the further sets 2 and 3 ghosts were apparent.

## North Bay Project (continued)

### DX INTERFERENCE

As could be expected, this antenna might be extra special in the field of ionospheric scatter. Hosken reports there is continual 10 and 20 kc. jamming on the WBEN signal (WBEN operates Channel Four minus). However jamming is much weaker than the WBEN signal. When TV is open for E Skip however, Channel 4 seldom shows signs of more than light co-channel interference, probably due to the very sharp beam pattern of the huge array. The only station on Channel 4 which comes close to lining up with WBEN is WRC in Washington, D.C., and it is several hundred miles too close for E Skip reception. Hosken notes "when other antennas are going crazy with E Skip here, the big beam seldom shows more than slight interference."

### 17 ELEMENT YAGI SALES

Although Hosken has exhibited no willingness to sell his famous long yagis for DXing work (we think this is a natural) or other community TV installations, he has manufactured nearly 100 for use in the North Bay area. Two versions are available to LOCAL buyers . . .

one modified to cover channels 2-6 with uniform high gain . . . the other covering the high channels (7-13).

### NEW PROJECT

Although TV on the local scene has crimped Hosken's community TV plans, it has not crimped his style. Experimenter Stan Hosken's latest brain child is a thirty foot rotating dish (or parabola) antenna, mounted at the summit of his backyard hill. Its purpose . . . to bring UHF television 300 miles from the states!

### PUBLISHER'S NOTE

In future issues of DXing HORIZONS, as the information becomes available, we will describe in "building detail" the North Bay long yagi, and the 30 foot parabolic antenna.

### NCTA "OVER THE TV HORIZON"

A free non-technical booklet describing fringe area community antenna TV systems in 700 U.S. CATV Systems is available from the National Community Television Association, 1111 E. Street N.W., Washington 4, D.C.

**Largest diversified tube stock in the Country! Write for tube price list . . . FREE.**

5654/6AK5W — \$1.50 Original boxed 5654/6AK5W/6096 — \$1.75 6096 — \$1.25

**TV DXers 6922 IN STOCK NOW!** (See page 22, this issue "D-H") \$3.50 PER TUBE.

#### RECEIVERS IN STOCK

NC-60 @ \$49.95 Drake 1-A SSB Receiver \$249.00  
G-50 @ \$299.50 RME Model DP-2 Preselector @ \$33.00  
HQ-145 @ \$279.00 RME Model VHF-152-A 2, 6 and 10 Meter/Preselector @ \$59.95  
HQ-180 @ \$429.00 SP-600-JX Hammarlund Super Pro \$450.00

- Silicon Rectifier — Input: 130 Volts RMS @ 500 Ma. .75c each (10 for \$7.00)
- RG59/U Coaxial Cable — .04c per ft.
- Glas-Line — \$2.89 per 100 ft.
- Intercom Cable — Color coded, prime material. 6 conductor (1 conductor shield). Rubber covered for outdoor use! \$70.00 per 1,000 ft.
- We buy and sell and swap as well. Cash for your unused tubes. Swap or Cash for your commercial equipment in good working condition. Write!

#### We are authorized factory distributors for:

ADJUST-A-VOLT, B & W, CBS, DRAKE, EIMAC, GELOSO, GENERAL ELECTRONICS GLAS-LINE, GONSET, HAMMARLUND, HEXACÓN, E. F. JOHNSON, NATIONAL CO., NATIONAL ELECTRONICS, PENTA LABS, STACO, TECHNICAL MATERIEL CORP., TOBE, VOCALINE, WESTINGHOUSE, and Others.

**Special Green Sheet Catalog No. H** — Chock-full of Specials on Transmitting and Receiving Gear, Transformers, Power Supplies, Capacitors, Meters, Microwave Components, UHF items, Test Equipment, etc. Everyone needs this handy catalog for Ready Reference on excellent purchases. Send 25c today. Ask for Barry's **GREEN SHEET CATALOG**.

**BARRY** ELECTRONICS  
CORPORATION Dept. H

512 BROADWAY, NEW YORK 12, NEW YORK • WAlker 5-7000

## TV Reporting

(Material in this section submitted by active TV DX'ers, and prepared by the staff of DXing HORIZONS)

### WINTER E SKIP SESSION

#### SYNOPSIS

A series of E skip openings, bringing in low band stations (2-6) 500-1500 miles distant swept across the country during the period January 8-12 with the peak opening apparently occurring the evening of January 11th, and affecting DX locations throughout the Rocky Mountain States, the West Coast, the the Southwest. DXers in the Gulf Coast states report skip on December 29, January 8, 9 and 11th. DXers in the area east of the Mississippi, north to the Great Lakes, and south to the Gulf Coast and Texas found the band open for E skip the evening of the 9th. Texas DXers found the low band open briefly for skip on Channel 2 to Nevada and Southern California the afternoon of the 10th.

#### OTHER DX FORMS

F2 DX made a slight upsurge after December 30th and BBC-TV and French TV from the European continent was received along the East Coast to 51 megacycles, and throughout the Mid-West and Rocky Mountain states (but not on the West Coast) to 48.15 megs on January 1, 3 and 4. The predicted Quadrantids meteor shower January 3 produced several good loggings between noon LST and 1600 (4 P.M.) LST (local standard time) over the entire U.S.A.

#### REPORTS

You may have noticed that DXing HORIZONS is devoting only one page per month to actual DX reports. This is a temporary measure scheduled to change in April, when a brand new form of DX reporting will be introduced on these pages. During the summer we will be experimenting with this new DX reporting method, and its variations, in which virtually every DX report and the name and location of each reporter will receive proper display. Please do not feel you are being neglected if your name does not appear on these pages before that time. To aid us in preparing the specialized reporting method, please mail your completed DX logging sheet (enclosed with most magazines . . . write for yours if you do not receive one) to this desk by the date indicated at the bottom of each column. Each report form should include DX for a 30-day period (30 days previous to deadline).

#### SOUTHEAST

Skip apparent the evening of the 30th to Mexico. Donald Ruland, Holly Hill, Florida reports a mystery spanish speaking station on Channel 3 1830-1845 EST the 30th . . . did anyone catch an identification on this one? Good skip to Texas, Oklahoma, Missouri on the 8th, 1925-2037 EST. Excellent Es to Mid-West and Great Lakes areas 1800-2100 EST on the 9th.

#### MIDWEST

Excellent ground wave opening the evening of December 16. E skip opening December 20th to the northwestern states, 1800 CST. Good E skip to the Atlantic Coastal States 1800-2100 January 9th. Excellent E skip session to Arizona, California,

Nevada, Oregon and Utah reported by DXers in Kansas, Western Oklahoma, Western Texas, and Western Nebraska on the 11th, DX began at 1915 CST and lasted until after 2200 CST. Jim Himes, Joes, Colorado identified skip on December 4, 6, 8, 24, 29, 30 and 31, and January 8 and 13th. On the 8th he logged KVOO (2—Tulsa), KTVU (2—Oakland, California), KOTI (2—Klamath Falls, Oregon), and KBES (5—Medford, Oregon).

#### NORTHEAST

E skip sessions the evening of the 9th of January affected many areas of the NE providing reception from Gulf Coast stations, and north through Oklahoma and Kansas. Boord, Morgantown, West Virginia, reports skip from KVOO (2—Tulsa) and KCKT (2—Great Bend, Kansas) December 24 from 1200 EST to 1400 EST.

#### PACIFIC COAST AND ROCKY MOUNTAIN STATES

Gordon Simkin, Idaho Falls, Idaho reports European TV reception January 3 to 48.15 megs (1030-1100 MST). January 3 also produced CKCK (610 miles) Regina, Sask., Canada and CHCT, Calgary, Alberta on meteor scatter, and bursts throughout the afternoon during the Quadrantids shower. Simkin also found rare wintertime ground wave to KOOK (2—Billings, 250 miles) and KGHL (8, Billings) January 8 at 1245 MST. On the 11th, during the big E skip session, Simkin logged Es first at 1945 MST, lasting until 2327 MST. Seen were KMID (2—Midland, Texas), KROD (4—El Paso), XEJ (5—Juarez), KLRJ (2—Las Vegas), KTVU (2), KRON (4) San Francisco. On the morning of the 12th, KVOO (2—Tulsa), WMCT (3—Memphis) were logged at 0625 MST before he had to leave for work. DXer James Gould, Sacramento, California, found skip as high as Channel 6 at 1900 PST on the 11th, with KTVR (2—Denver), KOOK (2—Billings) and KDIX (2—Dickinson, N.D.) logged through tough adjacent channel interference from KCRA his local Channel 3 station, only eight blocks away!

#### IN MODESTO

Here in Modesto we observed the skip on TV at 1730 PST but were not able to identify any DX until 1900 when KHAS (5—Hastings, Neb.) and WKY (4—Oklahoma City) were logged. These were followed by KFBC (5—Cheyenne, Wyoming) KOA (4—Denver), KCKT (2—Great Bend, Kansas), KCMO (5—Kansas City, Mo.), KOTA (3—Rapid City, S.D.), KDUH (4—Hays Springs, Neb.), KMTV (3—Omaha), KTIV (4—Sioux City, Iowa), and KOOK (2—Billings, Montana) as late as 2230 PST.

#### WE DO NEED YOUR REPORTS!

Report forms for reporting DX to this office are enclosed between pages 12 and 13 of most magazines. If your copy does not contain a DX reporting form, report your DX on a separate piece of paper and request a DX reporting form for next month. We need reports from every active DX fan . . . even if your report indicates you have seen no DX (thus telling us conditions were not very good in your area this report period).

Deadline for reporting DX for the March issue of DXing HORIZONS, February 14, in Modesto. Send all reports to Box 3150, Modesto, California.

# International DXing Horizons



## TV in the Land of the Bongo

One word describes the outlook for video development in the region known as the Caribbean . . . optimistic. Like their plans for revolutions, plans for TV and radio development are often brewed without adequate forethought. Consequently many stirring plans hatched on paper never go any further than paper. And many of these "paper ideas" are released to the public as fact . . . and while the public sits back and awaits the new operation, the "paper ideas" end up in a file unacted upon for years, and often forgotten entirely.

However, despite these problems, television in the Caribbean has grown very fast in the past half decade, and today there are 69 stations operating in the island countries, throughout Central America and as far south as the north coastal countries of South America. Not all of these stations operate according to fixed schedules, and few have anything like regularly scheduled program times. Some, like the Venezuelan stations, transmit programs when they get everything ready to go, and the staff is done with its coffee break or whatever! Half hour programs, on film, often start at nine minutes past the hour (or at any other odd time designation)! Not all of the operating stations bother to identify themselves between programs, although many transmit many hours of test patterns per week, as an incentive towards set installation. Some stations are government operated, but most commercial. And few use anything like medium or high power. Only the low band stations (possibly received via E Skip) are listed in this report, except those high banders in Cuba and Mexico, which can be received stateside by ground wave (tropospheric bending) on occasions.

### CUBA

Cuban television is all under one of three networks. Stations outside Havana are merely repeater, or relay stations seldom if ever with programs of their own. Some even carry test patterns from their Havana feed stations, thus explaining Channel 4 test pattern slides seen on Channel 3, etc.

#### Camaguey

3 — Radio TV Nacional (CMBF in Havana) 5 kw.  
5 — CMJL-TV (CMQ in Havana) 10 kw.

#### Havana

2 — CMAB (Radio El Mundo) 5 kw.  
4 — CMBF (Radio TV Nacional) 5 kw.  
6 — CMQ 10 kw.  
7 — CMBA 5 kw.

9 — CMTV 5 kw.  
11 — Telemundo S.A. 10 kw.  
**Holguin**  
4 — CMQ Relay 1.5 kw.  
8 — Radio-TV Nacional Relay 5 kw.

#### Jatibonica

12 — Telemundo Relay (Havana)

#### Las Villas

8 — Relay (Unknown)

#### Mantanzas

9 — CMGQ (CMO Relay) 5 kw.  
11 — Relay (CMAB — El Mundo)  
13 — Relay (Radio-TV Nacional)

#### Santa Clara

3 — CMH-TV (Relay CMBF) 5 kw.  
5 — CMHQ (Relay CMQ) 5 kw.

#### Santiago De Cuba

2 — CMKU (Relay El Mundo, CMAB) 5 kw.  
5 — Relay (Radio TV Nacional, CMBF) 5 kw.

### DOMINICAN REPUBLIC

Information secured by government sources and DX information does not mesh with D.R. stations. HIT-TV is assigned Channel 4, as a base station, and as a non-channel relay. However HIT-TV is assigned Channels 2 and 4, leading us to believe the relay operates on Channel 2.

#### Ciudad Trujillo

4 — HIT-TV, 16 kw.

#### Santo Cerro

2 — HIT-TV Relay

### EL SALVADOR

#### San Salvador

4 — YSU-TV Radio TV YSU S.A. 38 kw.  
6 — YSEB-TV Salvadorena S.A. 500 watts.

### GUATAMALA

3 — TGBOL-TV TV Guatamala S.A. 5 kw.

### MEXICO

Mexico's largest mystery involves the operation of XHNL-TV, Monterrey. Although the Mexican government says it operates on Channel 3, no one (DX wise) has ever seen a picture on 3 (or any other channel) although many have heard XHNL audio on Channel 3. One explanation . . . XHNL operates on Channel 10 (192-198 megs) and the audio heard on Channel 3 is from its tripler stage on 65.75 megs (there tripling to Channel 10). Being FM the audio is applied at a low level stage, of course, while the video only shows up on the final frequency, in high level AM modulation.

#### Chihuahua

10 — XERA 5 kw.

#### Ciudad Juarez

5 — XEJ 500 watts.

#### Madero

7 — XHGO

#### Matamoros

7 — XELD 5 kw.

#### Mexicali

3 — XEM 5 kw.



Tele Mundo, Channel 2  
Havana

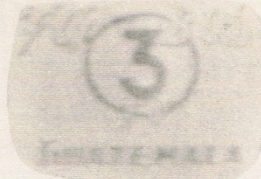

RARE TGBOL-TV  
Guatamala City, Guatamala, Channel 3

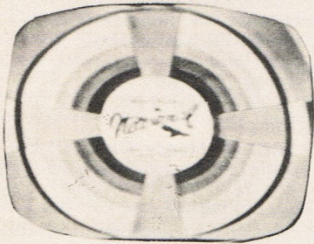

Television Nacional,  
Channel 4, Havana



XEW-TV, Mexico City, Mexico  
Channel 2



XHTV, Mexico City, Mexico  
Channel 4



CMQ, Channel 6  
Havana



WKAQ Test Pattern  
San Juan, Puerto Rico, Channel 2

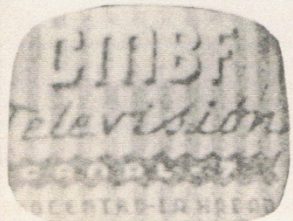

CMBF, Channel 7  
Havana

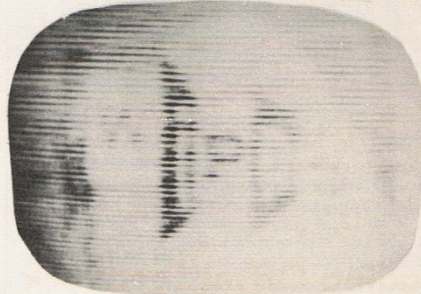

WIPR, San Juan, Puerto Rico, Channel 6

DXing HORIZONS is indeed proud to present this set of photos, gathered from numerous active DXers in the western hemisphere. Never before has such an array of Caribbean area call slides been published. Because call slide and test pattern IDS seldom change, it is thought this group may be of real benefit in identifying Spanish speaking stations at your DXing location. Our thanks to DXers Rauch (Ill.), Broomall (Ga.), Lowry (Texas), Beal (Arizona), Owens (Ohio), and Ruland Florida) for these photos.

#### Mexico City

- 2 — XEW 50 kw.
- 4 — XHTV 5 kw.
- 5 — XHGC 5 kw.
- 7 — XEX 5 kw.
- 9 — XEQ 5 kw. (Mt. top relay for XEW and XHTV)

11 — IPN Educational Experimental Station

#### Monterrey

- 3 — XHNL

#### Queretaro

- 3 — XEZ 10 kw. (Mt. top relay XEW, XHTV)

#### Tijuana

- 6 — XETV, 20 kw.

#### PANAMA

Several U.S. Airforce stations operate with low power high band transmitters here. Only one low band Panama station is on the air.

#### Colon

- 6 — HOHZ-TV 500 watts.

#### Panama City

- 2 — HOA-TV 500 watts (under construction)
- 4 — HOHM-TV 500 watts (under construction)

#### PERU

Operating hours are irregular at Peru's single low band transmitter, although many filmed U.S. programs (with Spanish dubs) are said to be used.

#### Lima

- 4 — CIA. Peruana De Radiofusion S.A. 5 kw.

#### PUERTO RICO

Puerto Rican television stations operate under U.S. authorization, with U.S. programming on film and tape. Many of the popular U.S. programs appear with Spanish language dubs. Many Spanish films are also used.

#### Mayaguez

- 5 — WORA-TV, 30 kw., ABC and CBS net.

#### San Juan

- 2 — WKAQ-TV, 100 kw. CBS-TV
- 4 — WAPA-TV, 56 kw., NBC and ABC net.
- 6 — WIPR-TV, 100 kw., educational station.

#### VENEZUELA

This is another country using many relays. Actual programming is said to come only from Caracas stations.

#### Barquisimeto

- 2 — YVKS (Caracas) Relay 500 watts.

#### Caracas

- 2 — YVKS Radio Caracas 62 kw.
- 4 — YVLV-TV Televisa Venezolana 15 kw.
- 5 — YVKA Televisora Nacional (Government operated) 37 kw.

#### Maracaibo

- 2 — YVKS Relay 600 watts.
- 4 — YVLU Relay 1,000 watts.

## Reading Offset Feedback

Several DX enthusiasts have misinterpreted last month's article "Reading Offset Interference." The article was not written with the intention of suggesting that a DXer could log a station without seeing the call letters or hear-

## Special DXing Horizons Exclusive

From GERALD BARTELL, *President  
Bartell Broadcasters Corporation*

The U.S.A. Radio Chain, Bartell Radio, has been granted exclusive video rights to operate television stations in Haiti, and the Dutch Islands of Curacao and Aruba (latter off the coast of Venezuela). On December 14 programming tests began at TELE HAITI, in Port Au Prince, Haiti. TELE HAITI, staffed by natives, but trained by Bartell personnel, operates on Channel 5 with a 500 watt transmitter. The transmitter is on famous LA Perchoir, high above Port Au Prince. TELE HAITI operates from 6 P.M. to 9 P.M. LST seven days per week. Programming is local live, filmed, and ABC-NBC from the states.

### MARCH OR EARLY APRIL

Promises to see two more Caribbean area stations on the air when transmitters are turned on at Curacao and Aruba. Curacao will operate on Channel 5, Aruba on Channel 7. Both stations will operate with visual electronics 500 watt transmitters. Programming here will be divided between U.S.A. and Netherland sources. Both islands are owned by the Dutch, and are wealthy oil spots north of the Venezuela coast.

ing the identification. The material was placed in DXing HORIZONS as a GUIDE towards better station identification during widespread DX openings. Armed with offset frequency charts, and having a knowledge of which areas the DX is coming from, the network programming (or lack of same) on the interfering DX station, the fading rate, and other variable factors, the editor feels the offset charts PROPERLY USED by a DXer will help (and only HELP) in the identification of a station which might otherwise go unidentified. Use of the charts, and your interpretation of the number of lines, etc. is a highly variable and non-accurate form of aiding identification . . . but it is a method successfully used by many DXers over the years. We hasten to point out the system takes practice . . . and is far from 100 percent accurate. Reading offset should never be the only form of station identification, or even the major form. Use it only as an aid and guide.

## TECH NOTES

Last month we discussed the advantages of Offset Interference, and how the alert DXer can pinpoint a station location by observing the number of interference bars on a known station. In the latter portion of this section a list of stations operating frequencies begins. This list will continue in the March DXing HORIZONS.

### THE 6922 TUBE

Perhaps you got the "gist" of two special sections in the January D-H. The front end tube (RF amplifier) in any receiver has a quality called its NOISE FIGURE. It is the noise figures which determines the sensitivity of a receiver. In recent months manufacturers of high quality TV amplifiers have shied away from the 6BQ7, 6BK7 type tubes in favor of the new AMPEREX 6922. The 6922 is a direct plug in replacement for the 6BQ-BK-7 series of tubes with several important advantages. On the high band (as well as the low band) the higher Trans Conductance of the 6922 gives it a MEASURABLY LOWER NOISE FIGURE and higher gain. In other words, for the price of a new tube, you can make a decided improvement in the quality of TV reception you have. The Amperex tubes are a product of Holland, but can be obtained at any large wholesale house in this country. If your local store does not have one, it is readily obtainable from Amperex Electronics Corp., 230 Duffy Avenue, Hicksville, L.I., New York. Write in care of Frank Randall, General Sales Manager. It is not an inexpensive tube, but it will outlast at least four of the 6BQ-BK series tubes, and out perform them right down the line. This is one item which will help separate the DXer's receiver from that of his non-DXing next door neighbor.

### DIPOLE FOR SKIP RECEPTION

If you are a DXer with one or more local (or semi local) stations on the low band (Channels 2-6) you know how hard and downright impossible it is to bring a weak, or even strong skip station (for skip station information, see "70.6 HOURS OF E SKIP" page 7 of this issue) through the local station. One trick, not too well publicized, but highly effective, involves the use of the simplest type of antenna . . . the Folded Dipole.

Properly employed, it will allow you to sneak skip stations through locals under all but the severest of conditions.

Almost all DXers have many element yagis, or some form of all channel antenna, mounted well into the stratosphere. Such an antenna does well on weak skip, ground wave, MS and most forms of DX, but being well above ground, it also scoops up many microvolts of signal from the local stations. In fact so many that even when it is pointed away from the local transmitter the local station is much too strong to be overridden by a station 1,000 miles or so away. BUT . . . a simple Dipole Antenna, mounted just above the roof, or even on the roof, picks up only a small portion of the signal from the local or semi local your big antenna does, and yet it works amazingly well on the skip station, which often gets pretty strong in its own right.

The directions are simple. Build a Dipole according to instructions, mount it either on a cheap second hand rotor you picked up from a local TV shop, or fix it so it can be rotated by hand (it can be mounted permanently also, if you follow the latter instructions). When you begin to notice skip interference on your local stations (or skip on a clear low band channel) switch to the simple Dipole antenna with a set of clips (never use a switch for switching antennas . . . the whys of switches will be explained in future months) and you are in business. The local signal will drop way down (strength wise) when you switch to the Dipole, allowing the skip signal to override it . . . and you can identify it! You will notice that by rotating the Dipole (which has two equal gain front lobes, at right angles to the Dipole itself) you can further knock out the local station, and in many cases bring up the level of the skip station. The skip signal, if it is strong enough to cause bars on your local station, when you are using your tall DXing antenna, will usually produce a picture when you switch to the Dipole.

### DIPOLE CONSTRUCTION

Using Chart One, select the channel (2-6) you are having the most trouble with locally. (Perhaps two channels, or even three) build the Dipole for that channel(s). (If you build more than one Dipole, it is OK to mount all on the same pole, on separate board mounts, but use separate lead in

#### CHART ONE

Working with Chart No. Two, use these figures for distances A1 to B1, and C1 to D1 for the respective channels. Length A1 to point D1 (total length) is equal to A1-B1 plus C1-D1.

A1-B1 and C1-D1

Channel 2	3' 11.5"
(U.S.-Canada)	
Channel 3	3' 8"
Channel 4	3' 3.5"
Channel 5	2' 10.5"
Channel 6	2' 8.5"

#### CHART TWO

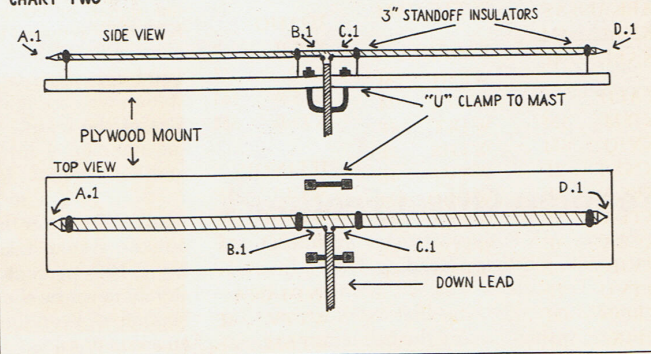



wires for each. If you can only build one Dipole, and are having trouble with more than one low band local, always cut the Dipole to the lowest channel you are experiencing trouble with.)

The insulators in Chart B are three inch screw eyes. The board is two inches longer than the Dipole on each end (board length determined by the Dipole length). The board is plywood, treated for weather protection with shellac. It is three inches tall, and one-quarter inch thick, and mounted to the mast with a simple SET OF U CLAMPS. The Dipole is constructed from GOOD QUALITY FLAT 300 OHM TWIN LEAD. The Dipole is soldered at all electrical connection points (A1, B1, C1, D1). The down lead (to the receiver) can be any length, but preferably kept as short as possible. It is also good quality 300 OHM twin line. Amphenol makes a good grade of twin line. (NOTE . . . To be covered in a future section, flat line losses . . . we recommend amphenol type 214-185 185 MIL brown flat line for all TV and FM DXing installations except long runs (more than 60 feet) and UHF work. Use a good grade of clip to connect the downline to the receiver.

With the E Skip season still eight weeks away, work on Dipole construction should begin now to put you in shape for the season well ahead of time, and to allow you time to get the feel of the Dipole antennas.

#### OFF-SET STATION LIST

(M is minus, P is plus, E is even.)

<b>ALABAMA</b>	<b>COLORADO</b>	<b>GEORGIA</b>
WAIQ 2M	KTVR 2E	WSB 2E
WBRC 6M	KOA 4M	WAGA 5M
WKRG 5P	KRMA 6M	WJBF 6P
	KREX 5M	WRBL 4E
<b>ALASKA</b>	KCSJ 5E	WSAV 3P
KENI 2M	KHQL 3E	WCTV 6E
KFAR 2P		
<b>ARIZONA</b>	<b>CONN.</b>	<b>HAWAII</b>
KPHO 5M	WTIC 3P	KONA 2P
KTVK 3P	D.C.	KHVH 4M
KVOA 4M	WRC 4M	KMAU 3P
	WTTG 5M	
<b>ARKANSAS</b>	<b>FLORIDA</b>	<b>IDAHO</b>
KNAC 5M	WESH 2M	KBOI 2
KARK 4E	WUFT 5M	KID 3
	WJXT 4P	KLEW 3M
<b>CALIF.</b>	WTHS 2E	KTLE 6M
KIEM 3M	WTVJ 4E	
KVIQ 6M	WDBO 6M	<b>ILLINOIS</b>
KNXT 2E	WEAR 3M	WCIA 3P
KRCA 4E	WEDU 3E	WBBM 2M
KTLA 5E	WPTV 5E	WNBQ 5E
KCRA 3E		
KVIE 6E		<b>INDIANA</b>
KTVU 2P		WTTV 4E
KRON 4M		WFBM 6E
KPIX 5P		

#### RESULTS

Use of the Dipole(s) in even the strongest of signal areas should make E Skip reception from stations 600-2000 miles distant a reality for all DXers now suffering from too many locals. DXing HORIZONS is always interested in results you may obtain and improvements you may discover.

#### USE OF OFFSET CHARTS

Using the three photos in the JANUARY TECH NOTES section as a guide, a DXer can plot whether the DX station interfering with his know station is operating exactly on channel or plus or minus. For instance, you live in the primary coverage area of WCIA-3, Champaign, Illinois. You know WCIA operates P or plus ten KC above Channel 3. Therefore you know that any station that is exactly zero beat (photo one . . . just a few bars . . . Jan. page 23) must also be operating 3P, or plus ten. But a station interfering and making bars such as photo 2 Jan. Tech Notes is ten KC AWAY, or in other words ON CHANNEL. And by the same token, a station making many bars, such as photo 3, Jan. Tech notes, must be operating 20 KC away, or minus 10 KC! In each set of interference conditions you can narrow the choice of stations down by observing first the beat interference, deducting from what type of station it is coming, and then checking your list of stations in the area DX is coming from, which operate to fit the beat interference you are observing.

Next month, the list will continue.

## 30-Day Wonder

An unexplained fire at the mountain top transmitter of KXLF-TV, Butte, Montana at 2:00 A.M. November 9th completely burned out the 10 KW RCA transmitter and all associated equipment. The completely locked 92 by 33 foot metal building smoldered for hours. But KXLF returned to the air in an unprecedented 30 days with all new equipment (see photo after new gear was installed). This though snows had begun to pile deep at the top of the continental divide where KXLF is located. In addition to the lost air time, tens of booster-repeater stations throughout Montana, and dozens of community TV cable systems went without signal, or made temporary conversions until KXLF-TV returned to the air December 9.



New KXLF-TV Rig

## FCC Analyzed

### CHANNEL 6 — NEW BEDFORD, MASS.

Half of the battle involving the allocation of a new station to New Bedford on 6 is over, with reported merger of the four applicants for the channel. The other half of the battle . . . to find a new site for the transmitter and antenna. The application for the new station specifies a location 168.8 miles from the transmitter of WCSH-TV, 6, Portland, Maine. FCC rules call for minimum 170 mile separation, and it looks as if they don't plan on making the New Bedford application an exception. New Bedford Channel 6 is the last low band VHF channel left open in New England region . . . when this is granted . . . there aren't any more!

### KVIT-TV MAY MAKE IT YET!

The mystery grant of KVIT to Santa Fe, New Mexico may be cleared up soon, now that the FCC has OK'ed move of KVIT transmitter to Sandia Crest, 43 miles southwest of Santa Fe and but 14 miles NE of ALBUQUERQUE! This will give KVIT big market status, and we know they mean business because they asked for (and received) permission to up ERP from 340 watts to 28,000 watts, visual!

### OTHER NEWS

KOB-4, Albuquerque has been granted FCC permission to broadcast still MOOD SLIDES and music for stereo cast with KOB-AM, Sunday A.M.'s, 9-11 A.M. MST. KXII-12, Ardmore, Oklahoma now identifies itself with Sherman and Denison, Texas, in call breaks. WTOM, 4, Cheboygan, Michigan will up power to 100 KW (now 26 KW). The antenna remain at 620 feet.

Inquiry continues into Channel Two, St. Louis grant, to KTVI. Channel 2 allocation, moved from Springfield, Illinois, had been granted WMAY THERE before FCC changed its mind and moved the 2 allocation to St. Louis. This may get "FCC sticky" before investigating committee is satisfied all was on up and up.

\$2.25 million UHF study proposed by FCC committee, Robert E. Lee and given preliminary budget bureau approval has hit snags . . . other FCC members figure the study is useless at this time. Lee is staunch advocate of all UHF TV. The study, purported to be an all inclusive technical look see, could settle usefulness of UHF once and for all.

RCA Ltd. announces the microwave linkup of 50 stations, to hook U.S.A. 48 states with Alaska will jump off at Grand Prairie, Alberta, go north to the Yukon-Alaska border. Microwave will carry live TV to 49th state.

KHQ-6, Spokane, building new 903 foot tower, at 4,549 foot elevation, on Krell Hill, SE of Spokane. They expect September '60 completion.

KPHO-TV-5, Phoenix is building new FM and TV transmitter building, and new tower. No ERP increase, or up in tower height announced yet however.

FCC is reportedly awaiting results of talk with military regarding possible assignment of five additional VHF channels above Channel 13 to TV, before attempting to shoehorn in other VHF's in crowded eastern areas where only two VHF'ers are operating. Outcome could mean doing away with UHF, using only 17 VHF channels for TV.

### FM NEWS

KADI (FM) signed on from St. Charles, Mo. December 22. They duplicate KADY (AM) until KADY sun down sign off, then continue with music until midnight sign off. KADI operates on 96.5 megs with 24.7 KW.

WSIX (FM) signed on December 21, with separate programming 8 A.M. until midnight from WSIX AM (both Nashville, Tenn.). WSIX operates on 97.5 megs with temporary 9 KW rig. An application has been filed with the FCC to operate on 97.9 megs with 30 KW.

### NEWS TOPICS

WGTV (10) Athens, Georgia has been shipped its turnstyle antenna from RCA. Look for a test signal from this 316 KW station at an early date.

Three groups have applied for the Channel 7 license in Winnipeg, in hearing held January 13-16. Look for an early decision.

Elsewhere in Canada, three groups are vying for new Channel 12 to serve eastern Quebec, northern New Brunswick. CHSJ proposes to locate a station at Campbellton, CHAU-TV would put the station at Carleton: CKCK would locate the new 12 at Upper Salquitch Lake, N.B.

### FACTS AND FIGURES

#### TRANSLATORS

People TV, Inc., Leadville, Colorado granted Channel 72 to translate KLZ-TV, Denver.

#### TV STATION APPLICATIONS

Tulare-Visalia, California, Sierra Broadcasting Co., Channel 27, 280 KW, 990 foot antenna.

Gallup, New Mexico, Channel 3, 950 Watts ERP, 170 foot antenna.

Kansas City, Mo., School District of Kansas City. Channel 19, 18 KW, 506 foot antenna.

#### NEW FM STATIONS GRANTED

Litchfield, Ill.	106.1	6 KW.	
Mt. Carmel, Ill.	101.1	4 KW.	WVMC-FM
Princeton, Ind.	98.1	7 KW.	WRAY-FM
Bay City, Michigan	96.1	10 KW.	
St. Louis, Missouri	98.1	76 KW.	
St. Louis, Missouri	92.3	22 KW.	
Brainerd, Minnesota	95.7	15 KW.	
Charlotte, N.C.	104.7	1 KW.	
Long Branch, N.J.	107.1	1 KW.	
Syracuse, N.Y.	102.9	9 KW.	WHEN-FM
Cincinnati, Ohio	90.9	4.7 KW.	
Collegedale, Tenn.	88.1	1 KW.	
Sparta, Wisconsin	97.1	16 KW.	
Seattle, Wash.	94.1	6 KW.	

### 417A BOOSTER

The best laid plans . . . as the saying goes . . . are not always all we would like them to be. We have learned much about the use of a 417A as a TUNABLE RF amplifier stage in the past four weeks of bench testing, the DXing Horizons unit, and one thing we learned worries us . . . our unit works fine on the lower range, but on the higher channels (10-13) it is not yet a stable circuit. Thus we feel at this time releasing the information relative to the building of this unit must wait. Engineer Cliff Price continues to fight the unit, which incidently, was working perfectly as we wrote last month. We have every confidence that it will be tamed in time for presentation in March or April . . . so stay with us . . . IT IS WORTH WAITING FOR . . . believe me!

R.B.C., Jr.

## SUBSCRIPTION NOTICE

# A Two Strike Ball Game

With this issue DXing HORIZONS will have reached 7,500 long range-weak signal TV and FM enthusiasts. We are a new magazine, and you as a reader are entitled to "try before you buy." The first issue of DXing HORIZONS came to you as a form of advertisement. In sending it to your desk we were saying, "This is our new magazine . . . won't you read it over?" And many did read it over . . . and more than 500 indicated their interest in DXing HORIZONS by subscribing. But we still felt that nearly 3,500 other enthusiasts who received the first issue SHOULD HAVE DXing HORIZONS ON THEIR DESKS EACH MONTH. So we decided to send along one more complimentary copy to a "certain percentage" of the 3,500 (we have many more thousands still waiting for their FIRST complimentary copy!).

Now, with a second copy in your hands (or the first, if you are receiving DXing HORIZONS for the first time this month) won't you carefully study its format, the news content, and the feature articles? Don't you have to admit . . . never before have you been able to find all of this weak signal news . . . all of these informative articles . . . in one publication? A monthly publication! We believe you can see these points with one issue . . . and if not, most certainly two. This is a monthly magazine . . . the news is as fresh as you will ever read . . . the articles and photo displays second best to none anywhere. These aren't our comments . . . this is what we have been told by the subscribers to the first month's DXing HORIZONS.

### REALIZE HOWEVER

That we have thousands of names to cover, in virtually every sector of the world. We must move on . . . with a new complimentary list each month. If you find in DXing HORIZONS information and news of lasting interest to you . . . may we suggest . . . and strongly urge, that you subscribe right now . . . TODAY . . . while the thought is fresh in your mind! The March issue begins DXing HORIZONS on an entirely new segment of weak signal enthusiasts . . . the shortwave listener (see below). Be with us.

### WE ARE INDEED PROUD TO ANNOUNCE FOREIGN RATE REDUCTION!

One thing about the subscription end of publishing DXing HORIZONS has bothered Bob

Cooper from the beginning . . . the high cost of mailing the book overseas. We want subscribers all over the world . . . especially with the birth of the shortwave sections in March. However, the postage alone to mail overseas is enough to choke a horse! Nonetheless . . . we feel we have made a precedent setting decision relative to foreign subscriptions . . . we at DXing HORIZONS are willing to swallow the large costs of mailing copies outside the U.S.A.-Canada block, merely because we feel world wide enthusiasts should have the benefit of DXing HORIZONS news. We are cutting the foreign surface mail rate from \$5.00 per annum to \$4.00 per annum, bringing it equal to North American mailing and subscription costs. We hope this unusual move on our part, and the faith we have in world wide interest in the magazine, will be justified in the subscription return and interest in the field.

### SUBSCRIPTION RATES: (U.S.A. and Canada)

One Year — Surface Mail.....	\$ 4.00
One Year — Air Mail.....	7.00
Two Years — Surface Mail.....	7.00
Three Years — Surface Mail.....	10.00
Foreign — Surface Mail.....	5.00
Foreign — Air Mail.....	Rates Upon Request

All subscription orders must be accompanied by a check, money order, or bank draft, made payable to "DXing HORIZONS MAGAZINE."

### SUBSCRIPTION INSTRUCTIONS

If the address on the back outside cover area is correct, you may return the bottom one-third of the cover (including your address) and enclose payment for your subscription. If you wish to preserve the magazine in its whole, simply send your complete Name, Address, Town, and State information, on a separate card or piece of paper.

DXing HORIZONS  
P. O. BOX 3150  
MODESTO, CALIFORNIA

### IN MARCH

We are as "proud as punch" to announce the March issue, and all to follow, will contain the world's first shortwave reception department. DXing HORIZONS expands to 36 pages, and brings a whole new section of magazine to the reader. Nowhere else in print will the reader find a complete monthly analy-

sis of shortwave reception and stations. Not merely a column, but A COMPLETE DEPARTMENT with several sections covering every phase of shortwave. And all under the very capable direction of the dean of shortwave . . . Kenneth R. Boord, Morgantown, West Virginia. See you in March!

### SUBSCRIBE TODAY

The New NEWS MONTHLY of the Weak Signal Field . . . DXing HORIZONS

## Distribution Systems

### Conversion Boosters

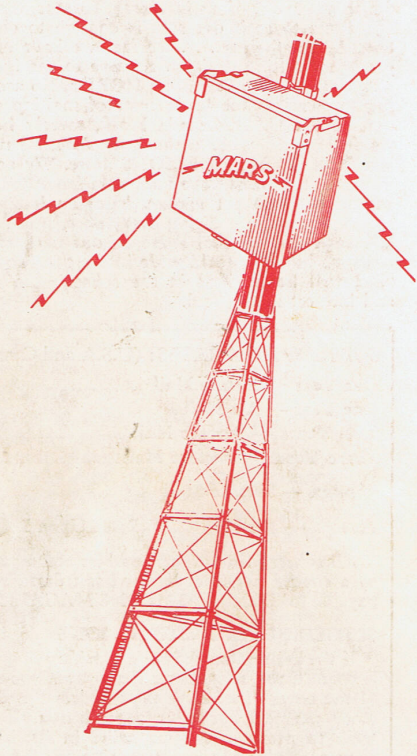

1. 10,000 Hour Reliability
2. First Quality Construction
3. Maintenance Free Operation (All VHF Channels)
4. Wide Range Input and Output
5. Simple Installation
6. .005% Conversion Accuracy
7. Switching Circuit to Monitor Output (RF) (Power Meter)
8. One Watt Plus Output Available
9. Premium Quality Amperex Tubes
10. Broadcast Quality TV Flat Response Amplifier

Planning replacement of your current system? Designing a new system? In the long run... in the short run... the best in quality equipment will save you time, money and hard to get at winter time repairs. Step up to quality... step up to M.A.R.S.

#### Mid America Relay Systems, Inc.

*Serving the Television World  
from the Heart of America*

601 Main Street, Rapid City, South Dakota

Postmaster: Form 3547 Requested

PAID  
U. S. POSTAGE  
Permit No. 53  
Modesto, Calif.

P. O. BOX 3150  
MODESTO, CALIFORNIA