

# VHF-UHF DIGEST

the official publication of the Worldwide TV-FM DX Association

SEPTEMBER 1977



## IN THIS ISSUE:

- All About Transmission Lines
- Pioneer's Car FM 'Supertuner'
- Major Market TV Vacancies
- More On FM 'Bootleggers'
- Some Really Super VHF/UHF DX!

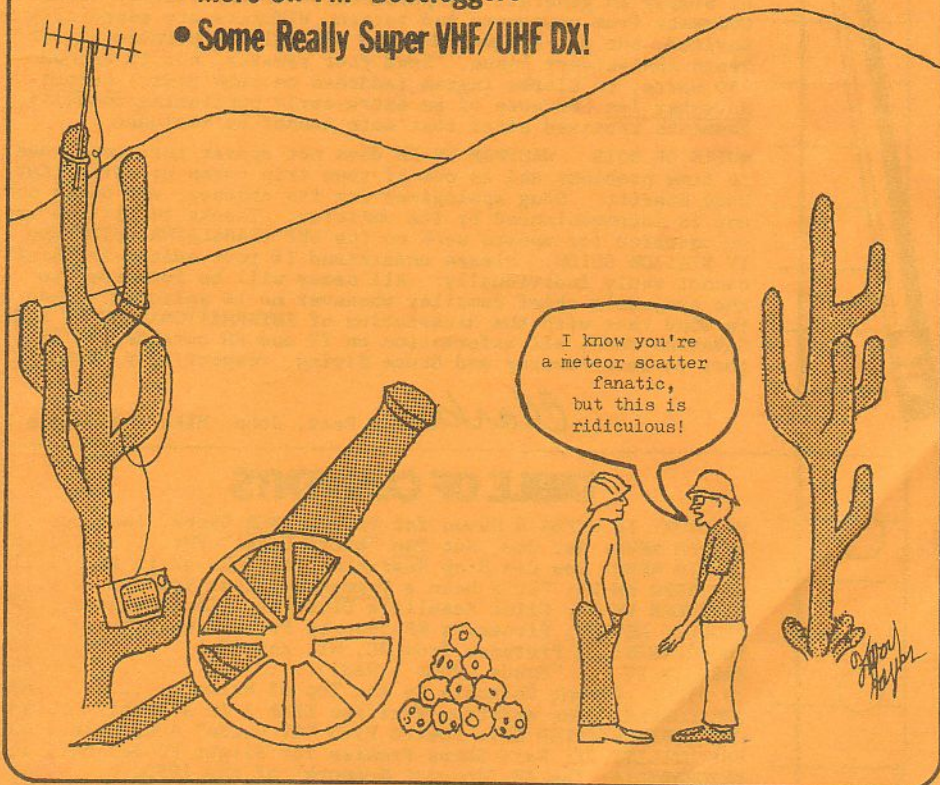



# From The Staff :

WTFDA Headquarters, P.O. Box 202, Whiting, Indiana 46394



CONVENTION INFO... The photo feature and wrap-up for WTFDA's Portland gathering in August did not arrive in time for use in this edition of the VUD, but should appear in the October Digest. Meanwhile, WTFDA is now accepting bids for our 1978 convention site. If you're interested in serving as host(s) for next year's gathering, please send your formal bid to editor-in-chief Clarke Ingram (address on back cover). State proposed site and tentative convention dates, and include if possible a paragraph on probable activities and available transportation to and around the proposed site. Whether or not you have submitted a bid, tentative or otherwise, prior to this notice, you must do so now to be considered eligible. The bidding will close on November 1, 1977 (no extensions!); accepted bids will be listed in the December VUD for voting, and results of the member balloting will appear in February.

AS JANUARY APPROACHES... WTFDA will soon be coming to the end of its tenth year of existence; and as we've said many times, our Tenth Anniversary Issue will be one you'll not soon forget! As this momentous occasion draws near, we invite all WTFDAers to send in their comments and opinions on the state of our club today as compared to past years, to other clubs, or simply in general, for publication in our January issue. Comments from newcomers and veteran WTFDAers are especially invited, but all are welcome and all will be printed in our Tenth Anniversary Issue. Send your remarks, not to exceed 250 words, to Clarke Ingram (address on back cover) before November 1st. Because of an extra-early publishing deadline, comments received after that date cannot be included.

NOTES OF NOTE... WESTERN TV DX does not appear this month due to time problems and an out-of-town trip taken by WTV editor Doug Everitt. Doug apologizes for its absence, and hopes no one is inconvenienced by its omission... Thanks to all who've volunteered for update work on the UHF TRANSLATOR GUIDE and TV STATION GUIDE. Please understand if your editor-in-chief cannot reply individually. All names will be forwarded to the project's chief compiler whenever he is selected... Keep in mind that with the dissolution of INTERNATIONAL NOTES and CANADIAN NEWS, all information on TV and FM outside the USA goes to Dave Pomeroy and Bruce Elving, respectively. Thanks!

73, *Clarke* for Pete, John, Mike and Morrie

## TABLE OF CONTENTS

MAILBOX: Is WTFDA a Haven for Veteran CBE DXers, Too?.....	3
FCC FM NEWS: Not One, But Two "Extra-Legal" FMs.....	6
FCC TV NEWS: You Can Stop Searching for WHRS-42 in FL.....	11
NORTHERN FM DX: "It's Been a Tremendous Year for Es".....	12
SOUTHERN FM DX: Clint McAuliffe Discusses SCA Adapters.....	22
PRODUCT REVIEW: Pioneer's KP-500, by Peter Sawatzky.....	24
PHOTO-NEWS: DX Pictures from NC, WY, and TX.....	27
EASTERN TV DX: "Egads, What a Wad!".....	28
TV STUDY: Vacant Channels in the Top 63 Markets.....	43
QSL CORNER: John Anderson Verifies KFAR-2 in Alaska!.....	44
CCI (UNIDENTIFIED DX): Puerto Rico "TV Guide" Available.....	45
VHF UTILITY DX: Fall Shows Promise for Slight F2 Season.....	46
MEMORABILIA: The FM "Concert Network" of the 1950s.....	47
T-LINES: Their Characteristics and Selection.....	48





# MAILBOX

John Zondlo  
6617 Maryland  
Hammond, IN 46323  
(219) 844-8694  
Deadline: 15th

## New Members:

Dr. Michel Breger	7217 Creekside Drive	Austin, TX 78752
John Clemmer	2937 W. Gilbert	Peoria, IL 61604
Steven Grimm	Box 8322	Erie, PA 16505
Dave Harms	Box 544	Altona, MB R0G OBO
Kenneth Kiihr	11620 Klebba	Taylor, MI 48180
Chris Landon	2 Casuarina Concourse	Coral Gables, FL 33143
Greg Lowery	Route 1, Box 82A	Gadwell, GA 31009
Ron Murray	Box 2873	Lancaster, CA 93534
K. Noffsinger	7240 S. County Rd. 25A	Tipp City, OH 45371
Steven Shaffer	10956 Indianapolis Blvd.	Hammond, IN 46326
Gary Siegel	2728 106th St.	Toledo, OH 43611
Kevin Slater	4996 13th Ave. N.E.	Salem, OR 97303
William Smith	Brown Terrace	Uxbridge, MA 01569
Brad Stanton	46 Dorset Drive	Canandaigua, NY 14424
John Timm	N28 W6246 Alyce, Apt. 221	Cedarsberg, WI 53012
Bernd Trutenau	Anton-Wattendorff-Str 1	D-4430 Steinfurt 2, West Germany
William Tudor	27 Griffin Ave.	Hoosick Falls, NY 12090

## Renewals:

Mike Dalton, John Dyer, Richard C. Evans, Doug Everitt, Paul Gaines, Ron Ginardi, David Martin, Vic Melis, John Parillo, Walter Patton, Don Ruland, Steve Sprachman.

## Rejoin:

Joe Fela-150 Robert Place-S. Plainfield, NJ 07080  
George Sherman-P.O. Box 2284-Minneapolis, MN 55402

## Renewals Due in October:

E.D. Bair, Tom Bishop, John Callarman, Jeff Driscoll, Robert Eddy, Charles George, Alvin Harvey, Vane A. Jones, Scott Levitt, Doug Mackey, Paul Malone, Dr. Joel Rosenberg, Carleton Sarver, T.B. Schickling, Darryl Sopata, Dr. Richard E. Wood, Bob Young.

"I was surprised at the number of "old" AM DXers in the club," says new member DR. MICHEL BREGER. Dr. Breger just bought the Panasonic RF2200 receiver, and says that the AM is quite good, even for splits, and that the FM has a few overload spurs of locals around 92 MHz.

Bradley University student JOHN CLEMMER is a member of IRCA and NRC. His equipment includes a GE multiband portable and a Realistic TRF.

STEVEN GRIMM found out about the club thru Communications World. For TV DX he uses an Archer V-125 at 30' and a U-100 at 50'.

Member John Anderson brought DAVE HARMS into the fold. Dave's DX gear is quite impressive: A Yamaha CT-800 tuner, a quad array of Delhi 10YFM (10 element) yagis at 64', a Delhi DXMD 64' self-supporting tower, GD AR-40 rotor, Blonder Tongue amp (15 db), and RG59U cable.

A recent article in Elementary Electronics by Morrie Goldman encouraged CHRIS LANDON to join. Chris has quite a few comments to make in Tidbits.

Reckon I'll let GREG LOWERY give his own introduction: "Happy to say that I've decided to join the WTFDA! I have been interested in shortwave DX'ing since December of '75--this led to my interest in pursuing TV and FM DX, which I have been doing since March of this year. My DX equipment includes a Sharp 2K-31B television, which is a black and white set with a 12 inch diagonal screen. My radio is a Hitachi KH-965H, AM-FM. For both of these I use an external antenna, which is a 22 element, yagi-type Channel Master. The antenna is at a height of about 45 feet, and is equipped with a Channel Master antenna rotator model 9512. I am relatively inexperienced in TV and FM DX, but I am sure that WTFDA membership will greatly increase my knowledge."

RON MURRAY is into VHF radio, and he found out about the club thru Police Call. He has 2 scanners, and also catches DX on CB.

Buckeye state new member K. NOFFSINGER is an 18 year old student who is interested in CCB and TV DX. His DX shack features an American Lazy-X antenna, an RCA XL-100 17" TV, a Channel Master 7' parabolic dish, a Channel Master rotor, and a Blonder Tongue amp. He learned of the club thru Communications World.

It's good to have another Hoosier in the club, and from Hammond no less! STEVE SHAFER joined after hearing my relentless sales pitch, hi, after ANARC Executive Secretary Dave Browne referred him to me. Steve uses Wards FM receiver #6282 and a Panasonic 12" black and white TV.

I've known GARY SIEGEL for a good many years, and it's about time he joined WTFDA! Gary is chief programmer for Channel 100, a pay TV outlet in Toledo. He's also a member of IRCA and NRC, with DX gear including a Panasonic RF 1200 receiver, an RCA color TV, and an antenna mounted at 40' with a rotor. During the recent IRCA convention, Gary and I, along with WTFDAer Bob Walker and IRCA Karl Forth, left the rest of the group on Saturday night and went to Bush Stadium in Indianapolis to see the hometown Indians play a doubleheader against Denver.....it was one of the highlights of the convention.

Oregonian KEVIN SLATER DXs the PSB and FM bands. He uses a Dynaco AF-6 tuner for FM, and he was referred to the club by Dr. Bruce Elving. Kevin is also a member of SPEEDX.

15 year old student BRADLEY STANTON found out about WTFDA from the Complete Shortwave Listener's Handbook. He has a rotatable TV antenna and a 77' dipole.

JOHN TIMM is a sales rep for WEZW in suburban Milwaukee. He's into FM DX, using a Sansui QRX 5500.

New member BERND TRUTENAU also claims membership in the Danish Shortwave Club International. DXing gear at his place includes a Siemens RG405 receiver, 1 indoor and 1 roof FM antennas, a Universum SK2752 TV, and 1 VHF and 2 UHF antennas set in different directions.

#### Tidbits.....

As promised earlier, we have several comments from new member Chris Landon.....perhaps someone can help him out: "I have read several books on MATV systems and am about to change our present omni-cheapo antenna to a rotorized deep fringe. In investigating technical specs from different companies, I find all of Channel Master's equipment to be superior. I've been unable to obtain specs on RCA's MATV products. The Channel Master equipment which seems best is the Model 1110 VHF/FM, with a mast mounted 7040 preamp; for UHF, the 4251 7' parabolic and a mast mounted 7364B UHF/VHF/FM preamp. The VHF/FM side of the 7364B will be used on our present crummy antenna and MATV system, with a 4403 FM antenna for omni FM reception. Of course, there's a 7208 FM/VHF splitter and a 7204 FM trap on the crummy antenna, and other goodies, like a 7008 H1 "Q" trap on channel 3, so a VTR with RF on channel 3 can be added at the head end. Stuff like single channel filters and sound carrier reducers could be added as needed later, but this local VHF/FM goes through our present MATV distribution system, which is old, and the splitters are hidden inside a wall. For the deep fringe system I'd like to use Belden 9230P, because of its "loss to outerdiameter ratio", but I wonder if I can find connectors to fit it. I've written them and have yet to receive an answer to that question, and to the question of why it's not sweep tested, and if this makes a difference. I've calculated completely the losses for the deep fringe system, and will use UHF like extending amps (7338). Here are my big questions: (1) Does RCA, or anyone else, make better equipment: antennas, as far as gain or directivity, or preamps, as far as signal/noise ratio? (2) Can I stack wide band antennas for added gain and directivity, say, a quad stack spaced .67 of a channel 2 wavelength, of four Channel Master 1110s? Will I get gain on all channels, and will I lose anything? (3) Can I stack 7' UHF parabolics? What happens with a vertical or horizontal stack of two 7' UHF dishes? (4) I have read that a vertical stack increases gain mostly in the "H" plane, and that a horizontal stack increases gain mostly in the "E" plane. I can find no information on E and H planes. Can you tell me anything about this? I know about horizontal and vertical stacks as far as fading and directivity are concerned. (5) How can I determine minimum distance between UHF and VHF antennas, in various configurations?



(Chris Landon, cont.) (6) What rotor would be best for all this, considering I'll have it modified to work from any of three controls, one at a time? Does anyone make a rotor with multiple control locations in mind? Chris' address is on page 3, if you can help him out.

My apologies to Robert Goodman for incorrectly listing his zip code in the July Mailbox....it should be 10461, not 40461. Robert has several comments this time around: "I turned on to Es accidentally last year on TV, and my primary DX interest is still TV. However, I'll also try for some FM meteoric scatter during this year's Perseids shower. FM MS even got a mention in the July 24 NY Times, as an aside in an article on the Perseids. The recent NYC power failure should have given area DX'ers a good chance to copy signals usually obscured by the locals. Unfortunately, here in the affected area itself, we needed battery power! Bela Chandler of Columbia University's Lamont-Doherty Geological Observatory says recent work suggests that sporadic E may have something to do with gravity waves. He's interested in our Es data, so I gave him WTFDA's HQ address. Of interest in tropo DX may be an article in a Scientific American last year (forget which month) on mirages. Since U/VHF tropo is analogous to visual looming, one might expect to get the former under conditions described as good for the latter. My own tropo correlates well with the presence of temperature inversions that produce lingering air pollution; so where there's fog or smog, there's likely also tropo DX. Mike Hogan tells me our Chevy Chase member (Hank Holbrook) uses aircraft reflection, normally associated with annoying multipath TVI, to advantage as a propagation mode. When broadcast TV was first taking form, consideration (apparently not too serious) was given to the idea of using circling aircraft to extend coverage range! I'd be interested in hearing of anyone's actual use of any FM, TV, or utility VHF DX propagation modes other than those cited in Beyond Shortwave. Here's a tip for anyone who wants to aurally monitor a TV channel for video: turn on an AM radio receiver near the TV receiver. Tune the radio to a frequency which is locally "dead", but which will beat with the video sweep/flyback signal to bring in a strong AM local. This allows one to monitor TV while looking elsewhere. Want a yardstick by which to gauge DX? Take the square root of the height (above average terrain) in meters of your receiving antenna, then add the square root of height in meters of the transmitting antenna (radiator). Multiply this sum by 3.6 to get a distance in kilometers. If signals traveled only in straight lines, and the earth were a perfect sphere completely opaque to rf, this is the maximum distance at which you could communicate. WBTB-68 Newark now has several hours a night of pay programming. Their scrambled picture, though, looks not much more so than many unintentionally ghostly pictures in Manhattan. Seems someone could easily construct a "pirate" unscrambler. (I disclaim any evil intent).

Here's a few kind words from Eldon Luoma: "Really enjoyed being a member of WTFDA during the past year. The VHF-UHF Digest is one of the best DX bulletin publications I've seen. I really feel the format is superior to other DX publications. The various colors make it easier for me to find a particular issue, too."

This in from Tom Yingling: "As you may have heard, the QSL Corner had some trouble with very little items being reported. Well, since the last issue of the VUD I have gotten a very nice surprise in that members have begun to report again. I got a lot of mail from the members, and will have enough for a while now if it keeps up the way it has. If you could put in your column my thanks to the members who have reported, and for the others to join in and show off their veries. I was quite happy to get the mail from the members, and it looks good for members to be active in their club."

Rejoining member George Sherman lists his DX interests as shortwave, FM, TV, and CCB, in that order. He's also a member of NASWA and NRC, with DX gear featuring a Pioneer TX-1000 tuner and a Winegard SC-650 antenna with rotor.

Steve Sprachman has some words on his recent adventures: "In April, I took a job selling dictionaries in the midwest for the summer, beginning at the end of May. For three weeks after school ended I was in Cave City KY, Nashville TN, Decatur IL, Springfield IL, Champaign IL, and Peoria IL. I got very little time to DX or anything else. I couldn't hack the moving around on the job itself, so now I'm home. I did get a chance to spend a day on the way home in Chicago. I stopped in at several radio stations, including WLS and an FM at about 100."

That's it for September.....see y'all in October.....jz





# FM NEWS

Bruce F. Elving, Editor  
18 1/2 East Fifth Street  
Duluth MN 55805

(and flip ahead two)

## New Station Grants

AZ Parker 99.3 3000 h,v; -139'; ar stations)  
Newfoundland Baie Verte 97.3 5850; CBC/CB(AM)  
NF Fleur de Lys 94.5 84 watts; " " "  
NF Portland Creek 103.1 850; " " "  
NF Roddickton 103.9 2000; " " "  
NF Mt. St. Margaret 99.9 10000; " " "  
NS Sydney 105.9 \$ 10000; CBC

## On Air and DX Ready (presumed)

AL Prattville WQIN (Calls, too) 95.3 3000 h,v; 230'  
AL Stevenson WWSV 101.7 940 h,v; 490'  
CA Mariposa KUBB 96.3 1100 h,v; 2080'  
FL Ocala WNFQ 92.7 1600 h,v; 290'; \$; a, Q-921  
NY Stony Brook WUSB \*90.1 4000 h,v; directional; 225' pj; on 7 am to 2:30 a. m.; \$  
NC New Bern WRBK 101.9, \*K-101, \*, r, r, 10000 h,v; 580' [409']  
OR Ontario KXBB\*-FM\* 96.1 27000 h, 3000 v; / TX Odessa KKKK 99.1 10000 h,v; 410'; \$  
UT Price KARB 98.3 3000 h,v; -114'

## On Air with Changes (selected)

CA Thousand Oaks KNJO 92.7 560 h,v, directional; 630'  
TN Cleveland WCLE-FM 100.7 on air with v

## Non-Ders (selected)

AK Anchorage KJZZ 102.1 K-102, or K-Jazz  
AL Gadsden WQMN 103.7 Q-104 (not Q-103)  
FL Miami Beach WWSL 93.9 Love 94  
FL Riviera Beach WQMN 94.3 GM-FM  
IN Elkhart WXAX 104.7 FM-105  
NH Dover WDNH 97.5 OR Radio 98 (possibly not a true non-Der)  
NY Riverhead WRCN-FM 103.9 FM-104  
NC Fayetteville WQSM 98.1 uses calls whenever mentioning Q-98, so not a true non-Der.  
NC Charlotte WROQ 95.1 Q-95  
NC Greensboro WRKQ 98.7 K-99  
NC Southern Pines WIOZ 107.1 W-107  
NC Wilson WXY1 106.1 Y-106, rm  
NC Winston-Salem WSEZ 93.1 \*WAIR\* (when duplicating AM); and Z-93. Format r, a.  
OH Lorain WZLE 104.9 FM-104, 9111  
PA Philadelphia WFIL 92.5 Y-F1  
TN Memphis WQUD 104.5 Quad-104  
VA Charlottesville WWSV 97.5 3WV, pr  
WI Reedsburg WR0B-FM 104.9 FM-104  
WY Sheridan KR0E 94.9 FM-94

## Call Letters

AL Birmingham 106.9 WXXK (from WERC-FM)  
AK Wrangell \*101.7 KSTK  
AZ Tucson 93.7 KR0Q (KXEN-FM)  
CA Auburn 101.1 KHYL (KAF1)  
CA Modesto 102.3 KFIV-FM (KITA)  
CA Tulare 106.7 KJUG (KWSM)  
CO Boulder 97.3 KBOD (KRNV); Seeks higher  
CG Sterling 96.7 KSTC-FM (KYOT) power and  
FL Clearwater 106.3 WAFR altitude.  
IL Mt. Carmel 94.1 WYER-FM (WSAB); \$ added.  
IL Peru 100.9 WIVQ (WGSY)  
KS Dodge City 93.9 KTIL ("cattle"?)

KS Garden City 97.3 KBUF-FM (KUPK-FM)  
KY Whitesburg 103.9 WXXO (WTCW-FM) [air.  
MI Caro 104.9 WJOL (WKYO-FM); not on /  
MN Mankato 99.1 KEEZ\*-FM\* (KEYC-FM) m,  
MO Montgomery City 103.9 KVCM (not ac.  
NC Morganton 92.1 WQXX (RNKC-FM)  
NC Charlotte 93.5 W0ZD  
OR La Grande 98.3 KLEW-FM (KFMF); \$  
PA Braddock 96.9 WFFM (WLOA-FM)  
PA Chambersburg 95.1 WIKZ (WCHM)  
TN Soddy-Daisy 102.3 WZQD (WZDQ); \$  
TX Corsicana 107.9 KXCL (KCIR)  
TX Harlingen 96.1 K1WV (KMBS)  
UT Ogden 95.5 KVFM; VA Luray 106.3 WLCC  
WV Clarksburg 106.5 WKKW (WRGT)  
WV Williamson 96.5 WXXC (WKCN)  
PR San Juan \*89.7 WRTU  
BC Burns Lake 99.1 CBXB\*-FM\*  
BC Fort Fraser 102.9 CBXR\*-FM\* [English.  
ON Cornwall 95.5 CB0C (not CB0F-6) / 98.1 CB0F-6 \* CB0C), French  
ON Ottawa 102.5 CB0F-FM (not CB0F\*-FM\*) 106.9 CK0-FM1 (all news; on the air; may have v as heard on car FM in Syracuse NY area; stereo generator used, but fraudulent stereo)  
ON Peterborough 106.3 CJBC-16, French  
ON Toronto 99.1 CK0-FM2 (not CKX0-2); all news, also believed to have fake \$  
ON Toronto 107.1 CILQ (presumed change from CFGN-FM)  
PQ Montreal 107.3 CITE-FM (same call as Sherbrooke PQ; same ownership—how can same call occur for stations in the same service but in different cities?); has \$stereo, v; nr.  
PQ Ste. Adele CIME\*-FM\* 99.5 has v; on air with \$, nr (this French station identifies only as "seem FM," usually accompanied by the sounds of birds, making it hard to pick out the correct call letters when listening to them).  
PQ Sept Iles 95.7 CBS1 98.1 calls unknown (I had assumed it was CBS1)  
PQ Trois Rivières \*93.9 CF0C\*-FM\* 100.1 CBFV\*-FM\*

## Formats/Networks

AL Albertville WQSB 105.1 S (AP Audio)  
AL Birmingham WBBM \*40.3 P  
AK Anchorage KGOT 101.3 pr (not k) KNK 105.5 mc (not cr)  
AR Fort Smith KMAG 99.1 pr (from m)  
CA Los Angeles KPOL-FM 93.9 rm KGBS 97.1 NBC (was S) KLVE 107.5 r (Spanish?)  
CA Ontario KSON-FM 93.5 rm  
CA Riverside KHNY-FM 92.7 r (from k)  
CC Lakewood KPPL ("K-People") 107.5 m  
CO Montrose KUBC-FM 94.1 m (not k) [99m  
FL Clearwater WQXN 97.9 r (not m); Rock  
GA Atlanta WREK \*91.1 pj  
GA Augusta WQUS-FM 102.3 k (from m)  
GA Columbus WCGO 107.3 C  
GA Toccoa WLEI-FM 106.1 U

ND Twin Falls KMTW 96.5 r (from nr)  
IL Carbondale WCIL-FM 101.5 r (not nr); Y, music SCA.  
LA Crete WIAS 102.3 mp  
FL Watsonville WQFA-FM 94.1 E (not Y)  
IN Auburn WIFF-FM 105.5 rg  
IN Bedford WBIF 105.5 m (not nr)  
IN Crawfordsville WLFQ 103.9 m (not k)  
IN Indianapolis WCAP 93.1 rp (not p)  
IN Monticello WVTL 95.3 m (not rk)  
IN Muncie WBST (to go to) \*92.1 cp (not cj)  
IN Terre Haute WTVS 100.7 mr  
IA Cedar Rapids KHAK-FM 98.1 delete M KTOF 104.5 add M  
KY Paducah WPAO-FM 96.9 rp  
LA Crowley KHIO 102.9 to be g  
MI Ann Arbor WIQB 102.9 pj  
MI Charlotte WCEB-FM 92.7 rm; \$stereo  
MI Dowagiac WQON-FM 92.1 U  
MI Fremont WSHN-FM 100.1 rk; \$ confirmed  
MI Grand Rapids WJFM 93.7 Mutual (CBS believed dropped; Muzak on SCA.)  
MI Lansing WILS-FM 101.7 pr  
MI Midland WRCI 93.5 rm  
MI Mt. Pleasant WCEB-FM 94.5 r (not kr)  
MI Newberry WNGY-FM 93.5 k (not m); on the air, 3000 h,v; 300'; monoponic.  
MI St. Johns WRB-FM 92.1 rm  
MI St. Joseph WIRX 107.1 NBC  
MI Spring Arbor WSAE \*89.3 l, "FM-89," \$ reported for them, but I did not hear \$ on them when on a recent trip.  
MI Tawas City WEBI 101.7 U  
MS Columbus 103.9 (new) rs  
MS Gulfport WQUG-FM 96.7 add M  
MS McComb WTBI 105.7 off air, but to be g  
MS Starkville WSMU 106.3 no stereo  
MS Columbia KTCG 96.7 add M  
MO Springfield KSMU \*91.1 P [NM Santa Fe KAFE-FM 97.3 r, (from m) NY New Rochelle WRTN 93.5 m (was NM Albuquerque KIPC \*91.5 r; adds \$) NC Asheville WRCS-FM 99.3 k(r) [NC Dunn WQTI 103.1 r, krg  
NC Asheville WBMU \*91.3 sj  
NC Boiling Springs WNGW \*88.3 ar  
NC Charlotte WROQ 95.1 pr  
NC Clinton WRRZ-FM 107.1 rk  
NC Greenville WNCY-FM 107.7 m (not km)  
NC Kinston WKNs \*90.5 m [NC Raleigh WRNC WQON 97.7 sr j, \*88.1 no l  
NC Morehead City WMBL-FM 95.9 m (not k)  
NC Raleigh WSHA \*88.9 sj  
NC Reidsville WMBN 102.1 U  
NC Rocky Mount WRSV 92.1 sg  
ND Minot KCJB-FM 97.1 rp (AM affiliate taking FM's former k)  
OH Akron WAUP \*88.1 j (not rj); has SCA authorization for talking book, but SCA is inactive; delete listing as an SCA station.  
OH Bellefontaine WIOO-FM 98.3 no \$; r (not k)  
OH Cleveland WCLV 95.5 Mutual; no SCA  
OH Columbus WNSM 100.7 rp (heard well into SE MI, where WITL-FM 100.7 Lansing should



FCC-FM

have been received)
OH Findlay WHMQ 100.5 k (from r)
OH New Philadelphia WNPQ 95.9 g (not m)
OH Port Clinton WRWR 94.5 m
OH Sandusky WLEC-FM 102.7 mk
OH Struthers WKTL \*90.7 rm (not me)
OK Broken Arrow KGOW 92.1 k (from r)
OK Sallisaw KRBB-FM 95.9 k (from r)
OK Tulsa KAKC-FM 92.9 m (Shulke Radio Productions' "all music all the time")
from r; misidentifies as "FM-93."
OR Portland KJIB 99.5 m (rm)
PA Beaver Falls WNKs, "Kiss 106," rp (not/
PA Butler WBUT-FM 97.7 rp (not m)
PA Wilkes-Barre WBRE-FM 98.5 N and S, still
all-news, despite demise of NBC's NIS.
SC Columbia WHMK \*89.7 gm
SD Rapid City KG66 100.3 Y
TN Columbia WKOM 101.7 k (from m)
TN Murfreesboro WNOT \*89.5 r
TN Nashville WLAC-FM 105.9 S (AP Audio)
TN Oak Ridge WUUU 94.3 rm
TX Arlington KNJ5 94.9 UPI Audio
TX Beaumont KVLV \*91.3 UP
TX Clear Lake City KMJQ 102.1 s; \$ presumed
added (was NBC's NIS)
TX Sinton KOUL 103.3 k (from m)
WV Beckley WCIR-FM 103.7 p (not mc)
WV Fairmont WFGM 97.9 m (not r)
WV Keyser WKLP-FM 94.1 r
VA-IN Bristol WFHG-FM 96.9 r (from k)
VA Harrisonburg WHRA \*90.7 P
VA South VA Gretna WJNA-FM 106.3 k, \$
VA Kilmarnock WKVI 101.7 m; \$
VA Roanoke WVRW \*89.1 pcj
VA Yorktown WYCS \*91.5 U
WI Menomonee WMMF 92.1 kr (from rg)
NB Richibucto CBHM 98.5 French; poor
coverage--not heard on car radio until
virtually in the town; id's only as "CBZ
Moncton" NB.
PQ Drummondville 104.3 CFDM? with CBF on air
after a year's absence; back on air
Montreal programs in \$; but with no i.d.
that is separate from CBF-FM. New calls?
PQ Sherbrooke CITE 102.7 r (was m)
PR Arecibo WNIK-FM 106.5; drops \$
PR Bayamon WEYA 94.7 drops \$
PR Mayaguez WAEL-FM 95.1; drops \$; has
English accompaniment to Spanish TV
PR Ponce WZAR 101.9 has English accompani-
ment to Spanish TV; music on SCA; believed
to be \$ when not carrying TV audio.
PR San Juan WPRM 98.5 English accompaniment
to Spanish TV--at least for part of its
schedule; stereo otherwise?

SCA (67 kHz) Activities

CO Boulder KGNU \*88.5 adds SCA
FL Naples WCVU 94.5 SCA inactive; delete

SEAVIEW

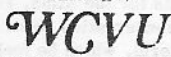

FM STEREO 91 • 100,000 watts

333 EIGHTH STREET SOUTH • JACKSONVILLE, FLORIDA

SCA listing.
GA Atlanta WKLS 96.1 no SCA
HI Wailuku KAOI 95.1 adds SCA
IL Carbondale WSIU \*91.9 no SCA, cm (not cj)

IL Chicago WKQX 101.1 no SCA
IL Moline WHTT 96.9 teleprinter noise (not
audible farm news)
IL Paris WACF 98.5 teleprinter noise (and
possibly some talk)
IL Urbana WILL-FM \*90.9 no longer believed
to be audible farm news; no SCA, except
for open carrier SCA for telemetry
IN Angola WLK1 100.1 no SCA; rock on main
channel
IN Fort Wayne WPTH 95.1 teleprinter only
IA Dubuque KIMI 105.3 " " "
KY Murray WAAM 103.7 Muzak
KY Paducah WPAO-FM 96.9 Muzak
MI Adrian WQTE 95.3 no SCA
MI Alpena WHSB 107.7 ABC relay (not music);
no \$ heard on main channel.
MI Cadillac WKJF 92.9 Muzak; non-ids as
"WIAM" (AM calls, with which it simul-
casts).
MI Clare WRNN-FM 95.3 no SCA; \$, r
MI Detroit WLDM 95.5 no SCA (was teleprin-
ter) WABX 99.5 " " " music
WRIF 101.1 no SCA
WDET\*101.9 adds SCA
MI E. Lansing WPMK 99.1 no SCA (was ABC);
rp on main channel (not nr)
MI Midland WUGN 99.7 no SCA heard (was
gospel programming)
MO Cape Girardeau KGMO-FM 100.7 music
MO Clayton KFUD-FM \*99.1 and KCFM 93.7 St.
Louis have identical Muzak
NC Laurinburg WSTS 96.5 no SCA heard (except
carrier; delete SCA listing)
OH Alliance WFAH-FM 92.5 no SCA
OH Ashtabula WREO-FM 97.1 music
OH Bucyrus WBFC-FM 92.7 no SCA
OH Canton WHBC-FM 94.1 Muzak [carrier.
WTOF 98.1 no SCA; gm on main /
OH Cleveland WZAK 93.1 Muzak; ethnic and
rock on main carrier; partine \$].
OH Cleveland WGCL 98.5 Muzak; WZAK, WGCL
and WHBC-FM all appear to have identical
Muzak; one probably picking it up off-the-
air from another.
OH Cleveland WQAL 104.1 no SCA
OH Marion WDIF 94.3 music
WWRN-FM 106.9 no SCA
OH Ottawa WPMN 106.3 no SCA
OH Toledo WIOT 104.7 " " (was to have
been Physicians Radio Network)
OH Wooster WWST-FM 104.5 SCA believed to
be for storm warnings; no SCA heard; but
announcements on main channel told of the
storm warning system available over
special receivers available from WWST-FM
that no other station in the U. S. has.
WWST-FM's SCA previously listed for music.
CA Bakerfield KYLD-FM 94.1 no SCA; rock
on main channel (was m) [music]
CA Bakerfield KGFM 101.5 no SCA (was /
KKXX 107.9 " " "
CA Fresno KFYE 93.7 Muzak
KYNO-FM 95.5 no SCA
CA Palm Springs KDCS-FM 104.7 adds SCA
CA San Luis Obispo KZOZ 93.3 no SCA
KUNA 96.1 " " "

September, 1977

CA Santa Barbara KCSB \*91.5 no SCA
KTMS-FM 97.5 Muzak
KRUZ 103.3 no SCA (was
Muzak) [music]
CA Santa Maria KSMA-FM 102.5 no SCA (was /
TX Nacogdoches KSFA-FM 92.1 music
VA Richmond WEZS 103.7 music
WI Milwaukee WKTI 94.5 Muzak

Facilities' Changes

AL Athens WJOF 104.3 610' (50000 h,v)
CO Morrison KWBI \*91.1 6000 h,v; 1180'
FL Miami WAlA 97.3 800' (98000 h,v)
KS Emporia KLRP 104.9 280' (3000 h,v)
MD Catonsville WKTK 105.7 has directional
antenna
MI Bay City WHNN 96.1 drops Dolby
MI Traverse City WLDR 101.9 50000 h,v;
590' (increase in v from 3 to 50 kn)
MN Rochester KRCH 101.7 1000 h,v; 560'.
NJ Glendive KIVE 96.5 has v; UPI Audio
NT East Orange WFMU 1450 h,v (360')
OR Eugene KPMM-FM 99.1 10000 h,v; 1510'
TN Memphis WSMH \*91.7 165 h,v (160')
TX El Paso KEZB 96.3 88000 h,v; 1390'
TX Houston KPFT \*90.1 100000 h,v (440')
TX Tyler KNUE 101.5 100000 h,v; 380'
WA Brenerton KBRO-FM 106.9 2380' (30000)
WI Racine WKRR-FM 100.7 500' (50000 h,v)
BC Hope CBUE on 105.1, not 101.7
NS Halifax 103.5 100000 all-news station;
said to be on the air; calls not given.
PQ Camp L63 CHLG 105.5 (not 100.5); Calls.
PQ Longueuil-St. Lambert CIEL 98.5 \$,
Dolby, has vertical
PQ Montreal CBM-FM on 95.1, with move to
93.5 apparently not materializing in the
near future.
DR San Francisco HIBI-FM from 107.7 to
101.9; power at least 250 watts; \$
(announced 102.3, but monitored on 101.9)

On Air with Stereo

AL Tuskegee WTVS 95.9, s
IL Dundee WVFV
AZ Sun City KWAO 106.3 103.9
AR Conway KHDX \*89.1
CA Grand Junction KMSA \*91.3 [Spanish
FL Miami WLRN-FM \*91.3 cj; some Latin, /
FL Marathon WNUM 94.3 m (not yet on air)
FL Winter Park WPFJ \*88.9
GA Gordon WKOG-FM 107.1, k [IN Paoli WVAK-
GA Statesboro WVG5 \*91.3 FM 95.3, k
ID Idaho Falls KUPI-FM 99.1, k
IN Washington WFML 106.5; k (not nr)
KY Stanton WSKY 104.9
MD Hagerstown WMDM 104.7
MI Mount Clemens WBRG-FM 102.7
MI Flint WFBE \*95.1 (to be \$ soon)
MI Sault Ste. Marie WSUE 101.3 k; no SCA
MI Ypsilanti WEMU \*88.1 j (not cr) has
plans to move to 89.1 with 15000, but
not yet an official change.
MT Bozeman
MS Indianola WMLA-FM 105.5 [MT Bozeman
KGLT \*91.9
MS Senatobia WJLC \*90.1, NV Las Vegas
MS West Point WKBB 100.9 [KRUD \*90.9
NJ Brick Town WBGD \*91.9 [MI Las Cruces
NJ Eatontown WHTG-FM 106.3 [MI Las Cruces
KASK 103.1
NJ New Brunswick WRSU \*88.7, cs [NY Kings-
NJ Upper Montclair WJSC \*90.3, pc on WBPM
NJ West Long Branch WMCX \*88.1, 94.3
NC Edenton WBBX 100.1 [(was Mutual)
NC High Point WHPF-FM 95.5 S (AP Audio) /



NC Raleigh WQPE \*99.7, c j  
 NC Roanoke Rapids WPTM 102.3  
 ND Mandan KNDR 104.9; m (not mg)  
 OH Granville WDOB \*90.9  
 OH Mansfield WCLM-FM 105.3; music on SCA  
 OH Oberlin WQBC \*88.7  
 PA Meadville WARC \*90.3 pr; ABC-FM  
 SC Pageland WCPL 102.3; rk  
 SC West Columbia WSCQ 100.1  
 SD Brookings KUSD-FM \*89.7 MN Talking Book /  
 SD Spearfish KSHU \*89.1  
 TN Carthage WRKM-FM 102.3  
 TN Cookeville WHUB-FM 98.3

TX Dallas KMGC 102.9; rg (still gospel music, but emphasizes rock gospel, the station tells me); music on SCA

# KMGC • FM

P. O. Box 5700 / Dallas, Texas 75222  
 TX Fort Worth KNOX-FM 107.5 IUT Logan  
 TX Graham KWQK 107.1, m (KUSU \*91.5 on 95.3)  
 TX Uvalde KYUF 104.9 (still on 95.3)  
 TX Wichita Falls KLUR 99.9 IUT Vernal  
 UT Orea KOHS \*91.5, mr (KU18 \*89.1)  
 VT Brattleboro WKVT-FM 92.7  
 VA Charlottesville WTJU \*91.3

VA Harrisonburg WEMC \*91.7, cg (PR Isabela  
 WA Pullman KQQK 104.9 m (from k) WKSA 101.5  
 WA Wenatchee KIAM 104.9 U  
 WV Charleston WQBE 97.5 k (not r); \*Q-97."  
 WI Neenah WEMI 100.1, heard testing with g; telemetry on SCA. (Nonaural station WTCH-FM Shawano has moved from 100.1 to 99.3.)  
 PR Aguada WRFE 105.5  
 PR Carolina WOLA 107.7; talk and music SCA  
 PR Hornigueros WGIT 92.1 PR San German  
 PR Mayaguez WQYE 94.1 WRPC 95.1  
 WORA-FM 97.5  
 VI Charlotte Amalie WCRN 101.1

**Abbreviations:** c classical, e ethnic, g gospel, j jazz, k country, L Latin, m middle of the road music, p progressive rock, r rock oldies, top hits, and "soft rock", s soul; A ABC-FM network, C CBS, E ABC Entertainment, I ABC Information, M Mutual, N NBC, P National Public Radio, S Associated Press Audio, U United Press Audio, Y ABC Contemporary. \$ is stereo; h horizontal effective radiated power in watts; v vertical effective radiated power in watts; SCA subsidiary communications authorization; FM frequency modulation; frequencies given in MHz (Megahertz—or "megacycles per second"); heights given are antenna heights above average terrain and expressed in feet—not tower heights, or altitudes above sea level. \* is a noncommercial station. "FM" is an Elving-type abbreviation meaning that a licensing authority has given the -FM suffix to an FM station's call letters when no like-called AM (or rarely, TV) station exists.

### Readers' Reports and Comments

But first, more new FM station grants from the FCC: AZ Nogales 98.3 215 w (horizontal only); 225', m. CA Nubieber and McArthur K276AK 103.1 \$, g (KVIP-FM 98.1 Redding CA translator); 10 watts.

CA Shafter 97.7 3000 h, v; 300'; mr, 15 miles primary, 46 miles secondary. MI Elsie \*91.3 10 schools. NM Taos 99.3 3000 h, v; -655', m; NC Plymouth 95.9 2600 h, v; 325'; WY Jeffrey City K296AY 107.1 (KTAK 93.5 Riverton WY translator); \$, m. Now, to the reporters, grouped alphabetically by their last names: Frank Aden, Jr., says a religious group plans to buy one of Bend OR's FM stations, but not known which one. KSUI \*91.7 Iowa City IA, now with 100 kw, reports Robert Baker, is on the air 6:30 am to 12:30 am daily, effective Sept. 1, having expanded this schedule considerably in two months.

Phil Boersma, Spring Lake MI, is one of several expressing this thought to the column: "Re the July FCC comments column, I feel that 'p' should NOT be replaced by 'a' in the guide. 'Album-oriented rock' is too broad a term, and its use in the guide could confuse some people. An FMer like, say, WDAI Chicago could be called 'album-oriented', since they play 'long' versions of top-40 hits, but they are not progressive; whereas WXRT is truly progressive—playing music that is avant-garde, which is not played on any other radio station in the market. Lumping WXRT in with WDAI would be a mistake."

Tom Cornell, Russ Brown and I all noticed WDUZ-FM Green Bay WI being off frequency (about 98.6 instead of 98.5), and Tom did something about it: he called WDUZ-FM and at first their engineer was surprised, but later confirmed to Tom that a bad IC in the frequency-lock loop let the oscillator drift, and they were actually 135 kHz high in frequency! They're on 98.5 now like everybody else.

Richard Clark took a trip to PR, and you'll find many of his observations reported in the small-print section. He also says there is a new stereo in DR, HL.. 106.1 "Radiorama," Sto. Domingo.

Mike Dorner sent an article in French from LeMonde, Paris, alluding to the fact that pirate FM radio stations flourish in France, as well in Italy. He also sent an article from the Feb. 1977 Audio from a Lou Schneider, chief engineer, KTIM-AM-FM San Rafael CA, claiming hi-fi AM performance.

Local interests in the Mpls. area are trying to get advertisers to boycott KQRS-FM 92.5 Golden Valley because of dropping p in favor of rp, or album-oriented rock. KWEY 97.3 Weatherford OK heard testing with tones in stereo, says Doug Everitt, who gets them with a 50 uv+ signal in Enid at 128 km.

Louisville's noncommercial twins, WFPL 89.3 and WFPK 91.9 have both gone to 100 kw, with WFPK even having some stereo. Ted Fleischaker, using a new Karkota SCA adapter, reports the PRN SCA on WSAI-FM Cincinnati is fairly weak, with less modulation than WTLC 105.7 Indianapolis puts out. With regard to the p vs album-oriented talk, Ted says "AOR is just a hype term by the stations seeking to change their image. This term means nothing because AOR could mean an album by Barry Manilow, which I consider rock, just as well as an album by the Eagles, which is rock, but which is progressive. . . . I'd just use a 'j' for that rock and say it stood for 'junk' and then spend my time dividing the m into 'b' for beautiful, 's' for standards, 'z' for easy, etc., which is mentioned to prove a point that there is no perfect way for all. . . . AOR is just a PR term used by stations, but as for the Atlas, keep the p, please!" Art Vuolo, Ypsilanti MI, who puts out radio guides, and I had a conversation about this, and he credits the industry publication, Radio and Records, for coining the AOR term, which he feels is quite useful in differentiating the major types of rock radio stations.

One of the most unusual reports in the history of this column comes from a Pittsburgh PA reader, Clarke Ingram, who has news not of just one illegal FM station but two of them. For more details, and logo, turn to the fine-print section of this column, starting on the next page, as Clarke Ingram infiltrates bootleg FM stations!



"WCKR-FM" 98.7 Carrick PA (about 10 mi S of Pittsburgh) has been on the air for about a month, repeating an AM bootlegger (1200 kHz) which has existed for 4 years! The FM is 25w; 30' AGL, but (unintentionally?) directional to the east; barely readable at this QTH, 5 miles distant. "WCKR-AM-FM" operates 7:05 to 11 p.m. except Tues & Sat nights; schedule seems very regular! Incredibly, "WCKR" carries ABC Contemporary news (Y) at nominal :55 each hour; this is taped off WCFM 98.3 Charleroi and may start on "WCKR" as late as :59! The phone is 412-885-4923, and it works; calling them while listening on July 22, I was invited to view their "facilities"—which amount to turntables, mixer, compressor, etc. all on a chest of drawers in one bedroom! The operator, though, has his FCC 1st license...so he seems to know what he is doing (though I wonder, with an FCC branch recently opened here). As a regular "WCKR" listener, my name often is mentioned on the air, and I took the liberty of doing the voice-over for their new recorded sign-on/off...I'll be able to handle QSL requests, but am not otherwise involved with "WCKR." While visiting, I mentioned my connection with VUD, and the owner (whose name is being omitted) was excited that "WCKR" would be featured in this issue...and I expect some "WCKR" folk to join WTEFA shortly. Some of the "WCKR" staff are already avid FM DXers! From the guys at "WCKR" I learned more about the mysterious "WBJQ" 88.7 Midland (known except on the hour as 89Q). Many of the same people are involved with both stations; the "WCKR" top-of-the-hour promos were done by 89Q personnel, DJs double at both operations, etc. On July 29, I was invited to see 89Q's facilities—which compare well to a small station—and, with the owner's permission, took some exclusive pictures, soon to appear in PHOTO-NEWS. "WBJQ" began in January 1975, and now feeds 50w input power into a highly directional antenna at 39' AGL, producing 50w ERP to the south; hence the crummy reception here. Dial 412-531-4487, and you'll reach a phone in the air studio; the 89Q transmitter has stereo capability, but 89Q is not \$, nor will they be unless the mono board is re-wired. Prior equipment problems resulting in 89Q's absence from June 30 to July 22 seem to be solved, and if "WBJQ" ever resumes a regular schedule, they might be a good shot on Es to the south for anyone with a clear channel on 88.7. I'll gladly handle verie requests for 89Q, but am not otherwise involved. And, no, neither station has v or SCA, Bruce!



Glenn Hauser just took a 7000-mile trip around eastern Canada, and because the news is so timely, and from an area where we don't see reports from every day, I'll quote from him extensively:

CBC-FM 96.9 Charlottetown PEI has local origination, all English it seems, and carries CBC AM network. Has tremendous coverage, through most of Nova Scotia, and almost to the NW corner of NB, where it begins to have interference from the Maine station. CBIM 93.5, also on the CBC French network, IDs as CBAF Moncton, and has good coverage into Cape Breton Island, but could barely detect on the N coast of PEI. On the N coast of CBI I found a parallel station on 94.3, which I assume must have been the Newfie. Kentville NS on 97.7 has a Dutch language program from R. Nederland ending at 0900 AT Sunday. In the Gaspé, 98.3 was audible east of Causapsca!, but not in Causapsca! The LPRIS in Cape Breton Island were both heard, since I went through the towns—101.9 and 103.9. CBH-FM Halifax has wide coverage; I listened to it on some of the hills of PEI, for instance. So does CBZF 102.3, squonched in between the Halifaxians. Transmitter site seems to be somewhere between Fred. and Saint John. . . CBJR-FM Rimouski PQ was still on, and apparently operating as before. I'm not sure if I heard an ID, but it wasn't carrying CBC programs. Here are some comments I hope you'll print, but only if you attribute them to me:

I don't agree with Bruce Elving's FM chauvinism, in criticising the carriage of CBC AM nets on some FM repeaters. CBC AM programming is so superior—and noncommercial—to anything on American radio, AM or FM, with the possible exception of NPR, that it should be brought to every inhabited place in Canada (and preferably in the U. S., too!) by whatever means available. The FM band is clearly preferable for this, because of its greater power efficiency, and its ability not to degrade further the audio fidelity of the network feed it is receiving. There is no reason in the world why every FM station has to be of extremely high fidelity. With FM emerging as the primary radio service, we should not object to stations carrying AM-type programming on FM, with AM-type fidelity, as long as there are still plenty which exploit to the fullest the capabilities of FM. (I may have been too hasty in condemning the CBC for this, as a Canadian reporter just called and said the northern stations, at least, are all fed by microwave, resulting in true high fidelity of CBC programs, and many of these stations break away from the CBC for local or regional originations; however, the CBC should be pressured into giving adequate identifications of all their stations, main as well as satellites and low-power relay transmitters.) Glenn goes on: There were some spots along the St. Lawrence, out of range of 104.7 Ottawa and AM where I couldn't find any English CBC AM net service on AM or FM, in the daytime on my car radio. Ground-wave of CBA 1070 Moncton, supposedly 50 kw, wasn't that great either in some parts of the Maritimes, and often wished there was CBC AM net on FM from Halifax, Fredricton and Saint John, not to mention the predominantly French area of NE NB.

WETS 89.5 Johnson City TN has a particular problem in that its transmitter on 4000' Holston Mountain, 22 mi E of J. C., is blocked in J. C. itself by a closer mountain. They ought to go the route of KPFA! But if WETS can't be heard clearly in its city of license, it has great coverage further west into Knoxville. . . I've been running DX promos on WUOT \*91.9 Knoxville whenever I'm at home noticing MUF into FM, but so far not much result in the way of DX reports reaching me.

Regarding my comment in the July VUD about wanting to cut down the size of the FM Atlas introduction, Atlanta's Nick Lombardi suggests cutting out FM miscellany, which would save almost 2 pages. Other items could also be cut out; Nick wonders if the new Panasonic RF2200 would work well with SCA, even though it has ceramic filters. I know the Panasonics with MPX out jacks work well; I will shortly be installing SCA into (or onto) one of the \$100 "big-mouth" sets. I have found ceramic filters are a problem with some portables, purposely designed for high selectivity, but not for stereophonic receivers, designed for a wide, but steep, bandwidth. Frank Karkota, designer of the SCA unit I sell, writes in response to my article that the crosstalk really isn't so bad on his SCA adapter, and he uses it with a TV set to demodulate the SCA station WCVB (TV) is experimentally using to cue its in-the-field news crews. Indeed, the FCC is considering allowing TV stations to use SCA for such purposes, including foreign language translations (especially useful in PR or in Canada).



Joe Markewitz, Hornell Heights, Ont., says the new Kingston CBC station on 107.5 is not Stereo, but he's heard a complete ID on it and it is different from the calls I report, CBCK. He thinks it is CBOC-1, similar to the Cornwall station on 95.5. In Manitoba, he's heard the new CBWX 95.7 in Fisher Branch, Man., which breaks away from CBW (AM) from noon to about 6 p. m. for its own northern service, hi-fi (by microwave from Winnipeg studios), mostly country music and local-service announcements. Then it rejoins CBW for a period of nonIDs, and at 1 a. m. CBW signs off, mentioning various relay transmitters. After that, a strange thing happens on Fisher Branch (and possibly other northern Manitoba stations); CBWX stays on the air with regional programming until 3 to 3:30 a. m., after which there is a test tone or open carrier all night. The new Brandon, Man. station on 97.9, CBWV, never IDs, and carries CBW(AM) exclusively, making it less interesting to listen to than Fisher Branch. It also makes reception of CHMM 97.5 Winnipeg difficult in Brandon. Also on the air, Fred McCormack reports, is CBWW 105.3 Baldy Mountain, Man., also mono, with no distinctive breaks. They don't have the CBW (AM) breaks, but only dead air at ID time.

WLRG 92.3 Roanoke, now at 2000' with 20 kw, plans to apply for 100 kw, but with a directional antenna (probably avoiding the south and WCSE 92.3 Asheville NC). WSEZ 93.1 Winston-Salem NC simulcasts with WAIR (AM), r, for part of its day, then is religious for the rest of the day—strange! reports David Nelson, Chapel Hill NC. WQMG 97.1 Greensboro NC easy-rock days, but soul at nights to pick up listeners of WEAL-1500 when that daytimer signs off. In Pensacola they hear:

Writes Walter Patton, Montreal PQ: CFQR 92.5 is still m most of the day, but after 2200 it is c or j depending on the day. CKMF 94.3 Montreal still m; they, like many French language FM's use the suffix -MF, the French equivalent of the English -FM. CJFM 95.9 Montreal, though an English language outlet, often gives its calls and frequency in French.

Ditto for CHOM 97.9 Montreal. Monophonic station CINQ 102.3 Montreal operates in five languages: French, English, Greek, Italian and Portuguese; they are on only parttime, covering only part of the city. In other parts of the city you hear WWSR-FM 102.3 St. Albans VT. WWSR-FM identifies as Stereo 102, but also gives its calls and city. CKO-FM 2 Toronto 99.1 and CKO-FM 1 Ottawa, with all news, should be easy to identify as they give their calls and locations very frequently. They use ABC for voice reports from outside Canada and just about everything in wire services for their copy. The CRTC has announced the licence for CFBC-FM 98.9 Saint John NB has not been renewed and the frequency will be available after Sept. 30, 1977 for applications from other parties. (It is not known if there will be an actual deletion, or if CFBC-FM will be allowed to stay on the air until another party, including CFBC-FM itself, should apply and be granted the channel.)

WFOG 92.9 Suffolk VA sometimes IDs as "This is your musical FOG," says Jim Pickering of VA. In Iowa, Michael W. Scheel, has not yet heard local K272AK 102.3 Davenport, but he has no trouble picking up KSUI Iowa City, despite a hill between him and them. WBST Muncie IN is having continued problems from local zoning authorities to build its 300' tower and go to 3 kw on 92.1, with construction already underway, but local officials are threatening suit to stop the building efforts.

Muncie's Ralph Strobel wonders if WVUB, r, \*91.1 Vincennes IN has quit stereo.

CA's Don Voegelé sends information on "Optimod FM," which is a system at a station consisting of compressor, limiter, and stereo generator, which may give Dolby a run for the money. Don says there is now a 5NCR-FM 92.5 in Brisbane, Australia., with FM in Melbourne (2 stations), Canberra, Adelaide and Sydney (at least three stations). Dave Walcutt, Carbondale IL, who bought an SCA adapter from me at the ANARC convention in Chicago, hooked it up to a Sony ICF-5900W with a MPX Out jack, and it worked fine, resulting in some of the SCA news reported previously. Building his own SCA adapter after reading my articles is Steven Wiseblood, who installed it in a Pioneer SM Q300B. He says "Although only 2 SCA stations were heard with the adapter so far, you can bet I'll be searching relentlessly for others, and won't stop until I come across others. Has anyone ever tried to DX SCA alone? On meteor scatter?" [I doubt it; but I came close to it on a car trip recently to Akron OH from MN, when I had SCA reception the entire distance, and which provided much of the midwest SCA news]

Contributors: Frank Aden, Jr., Bend OR; Robert Baker, Humboldt IA; P. Boersma, Spring Lake MI; Thomas Casweller, Dunmore PA; Tom Cornell, Kokomo IN; Richard Clark, La Vega, Dominican Republic; Mike Dornier, Jr., Metairie LA; John Ebeling, Bloomington MN; Doug Everett, Enid OK; Dale Fife, Concord NH; Ted Fletschaker, Louisville KY; Glenn Hauser, Knoxville TN; Clarke Ingram, Pittsburgh PA; Edward H. Isotale, Appleton WI; Nick Lombardi, Atlanta GA; Paul Louks, Saginaw MI; Earle Lyons, Belleair Bluffs FL; Joe Markewitz, Hornell Heights, Ontario; Frank Merrill, Toledo OH; Fred McCormack, Fargo ND; David Nelson, Chapel Hill NC; Walter Patton, Montreal, PQ; J. R. Pickering, Williamsburg VA; Jay L. Rudko, Elmendorf AFB AK; Michael W. Scheel, Davenport IA; Robert Seaman, Hometown PA; Ralph Strobel, Muncie IN; John Timm, Ph.D., Milwaukee WI (who says he is joining WTFDA, and he's heard lots of skip to the gulf coast states; also VA, NC and SC); John is manager of  
Also: Don Voegelé, Stockton CA; Arthur Vuolo, Jr., PO Box 219 Ypsilanti MI  
46197 (send 25¢ for a copy of his rock or country music radio guides); Dave 1572 E. Capitol Drive  
Walcutt, Carbondale IL; Steve Wiseblood, Santa Maria CA; Larry Weil, E. Rockaway NY; Thomas J. Yingling, Jr., Baltimore MD.



WEZW  fm Stereo 104  
Milwaukee, Wisconsin 53211



# FCC TV NEWS AND DATA

Dave Pomeroy  
KTWU--Channel 11  
301 N. Wanamaker Rd.  
Topeka, Kansas 66604

September 1977

## TV Applications

Leesburg, FL	(55)	221.4kw	316AAT
Albany, GA	(19)	640kw	975AAT
*Johnson City, TN	(41)	723kw	2306AAT
Rosenberg, TX	(45)	1350kw	550AAT
Albany, GA	(31)	2630kw	1190AAT
Jacksonville, FL	(30)	4176kw	976AAT
Miami, FL	(33)	1216kw	1018AAT
Baltimore, MD	(54)	1205kw	812AAT
Denver, CO	(31)	2703kw	975AAT
Tampa, FL	(28)	745kw	1429AAT
Norfolk, VA	(33)	1135kw	910AAT
Santa Fe, NM	(11)	90kw	4090AAT
Green Bay, WI	(26)	224kw	565AAT
Concord, CA	(42)	1205kw	2773AAT
Houma, LA	(11)	316kw	502.3AAT
Washington, DC	(14)	505.9kw	468.9AAT

\*non-commercial, public television stations

## CP's Granted

Dallas, TX	(33)	300kw	1633AAT
Ft. Wayne, IN	(55)	599kw	782.9AAT
Kansas City, MO	(50)	676kw	1120AAT

## Call Letter Applications

KNBN-TV Dallas, TX	new
*WCME Chicago, IL	now WXXW-20
WIVB Buffalo, NY	now WBEN-TV
WSET-TV Lynchburg, VA	now WLVA-TV
WFFT-TV Ft. Wayne, IN	new ch 55
WMVW Hanover, NH	new
WANX-TV Atlanta, GA	now WHAE-TV
KIMT Mason City, IA	now KGLO-TV
WHME-TV South Bend, IN	new

## Call Letters Granted

*WQPT Moline, IL	new
KYFC Kansas City, MO	new ch 50
KTVZ Bend, OR	new ch 22
KSGW-TV Sheridan, WY	new
*WJPT Bluffs, IL	new
KTUX Rock Springs, WY	new
KICH Longview, TX	new ch 16
WJLA-TV Washington, DC	was WMAL-TV
WJKN-TV Cleveland, OH	was WJW-TV
WMBB Panama City, FL	was WDTB

## Translators Granted

K21AB Colorado Springs, CO	KTSC
K06SE Cripple Creek, CO	KTSC
K58AQ Steamboat Springs, CO	KRMA
K68BC Lewiston, ID	KSPS
W56AT Augusta, KY	WCVN
K11NZ Ashland, MT	KYUS
K130P White Sulphur Springs, MT	KRTV
K08IJ Gallup, NM	
W17AA Celina, OH	WOET
K070W Agness, OR	KOBI
K61AS Pickstown, SD	KTSD
K69BL St. George, UT	KLAS
K09NU Glenwood, WA	KPTV
K06JD Bullhead City, AZ	KVVU
K04IY Lake Havasu City, AZ	KVVU
K60AX Kingman, AZ	KVVU

## Translators Granted

K58AP Topock, AZ (Needles, CA)	KYVU
K55BH Baudette, MN	KTHI
K57AR Baudette, MN	WDAZ
K57AS Grygla, MN	WDAZ
K59AX Grygla, MN	KTHI
K69BK Morris Camp, MN	KTHI
K67BC Norris Camp, MN	WDAZ
K63AS Williams, MN	KTHI
K61AR Williams, MN	WDAZ
W63AH Maplewood area, OH	WOET
W60AH Stroudsburg, PA	WDAU
W59AG Wintergreen, VA	WVIR
K08IZ Crouch, ID	KIVI
K03ET Terrace Lakes, ID	KIVI
K04IZ Wawona, CA	KVIE
K04JA Del Norte, CO	KNME
K64AR Steamboat Springs, CO	KWGN
K09NS Clearfork, CO	KOAA
K08IY Victoria Mines, NV	KUTV
K19KL Victoria Mines, NV	KCPX
K64AS Ruidoso, NM	KOB
K67BD South Fork, NM	KOB
K69AO Millersburg, OH	WOUC
K070V Green River, UT	KUED
K05GH Hydro Jet Services Mine,	UT KSL
K070U Federal Mining Camp, WY	KOA
W60?? New York City, NY	WBTB
(atop World Trade Center)	
K04IX Anatuviik, AK	KYUK
K070S Diomedes, AK	various
K120N Glen Haven, CO	KRMA
K12KV Lake City, CO	KBTY
K05GG Gibbonsville, ID	KGVO
K61AQ N. Steptoe Valley, NV	KSL
K69BQ Quinn River, NV	KOLO
K06JB Gaita, NM	KGGM
W67AK Belfast, NY	WNED
W65AH Loudonville, OH	WOSU
K07LJ Eagle Butte, SD	KPRY
K06JA Ceder Canyon, UT	KTVX
K070R Ceder Canyon, UT	KUTV

## FROM THE READERS:

KTVZ-21 in Bend, OR expects to be on the air by November 1 as an NBC affiliate with some ABC programming...WHRS-42 in Boynton Beach, FL reported on in this column in June is just "talk" not "talk programming"; will not be on in the near future...WHFT-45 is seeking approval to use West Indies network...Channel 50 in Kansas City, MO expects to be on the air next summer with "Christian programming," studio will be in Kansas...ABC is continuing to gain new affiliates away from CBS and NBC; WSOC in Charlotte, NC now with ABC--NBC will have choice of WCCB-18 or WRET-36...KCST-39 in San Diego is now NBC...KVFD-21 in Ft. Dodge, IA still off the air due to tornado damage...Iowa ETV network will complete coverage of the state with six translators; Keokuk(44), Ft. Madison(38), Sibley(33), Rock Rapids(25), Ottumwa(38), Keosauqua(54). Thanks this month to Ken Simon, Shel Swartz, Robert Baker, Frank Aden, Jr., and Bruce Elving.



# NORTHERN FM-DX



Fred Nordquist  
7945 Boxford Road  
Clay, NY 13041

September 1977

Deadline: the 10th

For FM DXers in Canada, the Northwest-Central states of WA OR ID WY ND SD NE MN IA, and all states east of the Mississippi River and north of the Mason-Dixon Line. Report your DX !!!

It's been a tremendous year for E-skip. Peter Sawatzky passes on this quote from Bill Tynan, W3XO from "The World Above 50 MHz" (QST, Aug. 77, Pg. 82) regarding Es activity this season on the 6-meter band: "As this is being written, it is mid-June. Even if not one more opening occurs for the rest of the summer, 1977 will go down in history as the 'best Es year' since those first DX signals startled 5-meter operators 42 years ago." (by 5-meter he is referring to different band allocations back then). Es openings were noted in July/August by this month's reporters on: 7/1,2,3,4,6,7,9,11,12,22,23,25 thru 31, and 8/2&3.

Rod O'Connor - P.O. Box 72 - Southwest Harbor, ME 04679 (EDT)

Eqt. Realistic QTA RX, Winegard 7-el. ant. aimed WSW, Winegard FM340 booster. Antenna hand rotatable, but attic mounted to protect it from sea gulls (Maine's #1 antenna killer)

7/1	Es 2045 WGMW	94.3 FL Riviera Beach(1025)	7/26	Es 1947 KXLS	96.1 AR Elythville (1350)
	2050 WCVU	94.5 FL Naples/Fort Myers		2030 WXID	94.7 KY Mayfield, "D-94"
7/7	1540 WMHK	89.7 SC Columbia (1025)	7/28	1530 WFBQ	94.7 IN Indianapolis (950)
	1543 WJCL	96.5 GA Savannah, EL (1150)		1535 WRXX	95.3 IL Centralia, "REX"
	1550 WKPT	98.5 TN Kingsport (920)		1645 WKTM	102.5 SC Charleston, "\$-KTM"
	1558 WSB	98.5 GA Atlanta (1175)		1656 WKTZ	96.1 FL Jacksonville (1300)
	1601 WMUU	94.7 SC Greenville (1020)	7/29	1700 WCWC	95.9 WI Ripon (1100)
	1602 WESC	92.5 SC Greenville		1701 WNNO	107.1 WI Wisconsin Dells
	1603 WEZS	103.7 VA Richmond, "E-Z 104"		1702 WDLB	106.5 WI Marshfield(1150)
7/12	1900 WSGF	95.5 GA Savannah (1150)		1703 WCCN	107.3 WI Neallsville(1200)
	1901 WJCL	96.5 GA Savannah		1705 WIAL	94.1 WI Eau Claire (1250)
				1797 WJPB	92.3 MI Ishpeming (1080)

Hope all are getting good skip -- best to all, Rod.

Mike Bugaj - 69 Sherman Road - Enfield, CT 06082

Eqt: Sony 5130, Finco FM-5 @ 35' w/rotor. What a summer for Es. Most of my loggings were on E-W paths for change. 178 new stations logged since 5/6 with only 16 via tropo. Total now about 813. 7/14 tropo good to Columbus, Ohio @ 560 mi. No relays are listed except for some good tropo relays, and these are underlined.

5/6	Tr	1730 WHBI	105.9 NJ Newark	lightning	6/6	Es	1959 WLQL	99.5 MN Minneapolis
		1742 WIGY	105.9 ME Bath, Y106	knocked			2005 WWIB	103.7 WI Ladysmith
		1805 WQXA	105.7 PA York, Q106	locals			2005 KCMT	100.7 MN Alexandria
		1810 WFLN	95.7 PA Philadelphia	off.			2015 KBMO	93.5 MN Benson
		1815 WZID	95.7 NH Manchester				2030 WWJO	98.1 MN St. Cloud
5/22		2132 WBPZ	92.1 PA Lock Haven		6/8		0915 WBGJ	92.1 ?? Ga.?
5/29		2130 WMHR	102.9 NY Syracuse, gospel				0925 KZZQ	94.3 LA Golden Meadow
5/30		0228 WSEA	93.5 DE Georgetown				0933 KCKN	94.1 KS Kansas City
		0235 WBLK	93.7 NY Depew, soul				0940 WAAG	94.9 IL Galesburg
6/1		1830 WPFW	89.3 DC Washington				0945 KFMH	99.7 IA Muscatine, "99+"
6/5	Es	0950 WHRS	91.7 FL Boynton Beach				0947 KLEE	97.7 IA Ottumwa
		1015 WYRL	102.3 FL Melbourne				0948 WHTT	96.9 IL Moline
		1215 WRGI	93.5 FL Naples				0952 KIHK	103.7 IA Davenport, "Kick"
		1715 WRUL	97.3 IL Carmi				0952 KILJ	105.5 IA Mt. Pleasant
		1715 KTJJ	98.5 MO Farmington				0956 KMGR	93.3 IA Des Moines
6/6		1020 KSMB	94.5 LA Lafayette				0957 KOWH	94.1 NE Omaha
		1745 KCPI	95.3 MN Albert Lea				0959 KHAK	98.1 IA Cedar Rapids
		1745 KTTT	93.5 NE Columbus				1000 WZOL	97.5 IL Rockford
		1750 KPAT	97.3 SD Sioux Falls, Rock107				1003 KPRL	103.3 IA Pella
		1758 KSTP	94.5 MN St. Paul				1005 KDWI	105.3 IA Dubuque
		1800 KVDB	94.3 IA Sioux Center				1007 KYEL	105.7 IA Waterloo, "X-Rock"
		1810 KHBT	97.7 IA Humbolt				1014 KFMD	92.9 IA Dubuque, "D-93"
		1811 KSEZ	97.9 IA Sioux City				1018 KECC	95.5 IA Sioux City
		1910 KQDE	92.1 MN Waseca				1025 WLSU	88.9 WI LaCrosse
		1910 KWQA	95.1 MN Worthington				1028 WCAL	89.3 MN Northfield
		1912 KNEI	103.9 IA Waukon				1035 KAGE	95.3 MN Winona
		1925 KQIC	102.5 MN Willmar				1155 WNMU	90.1 MI Marquette
		1929 KIOV	104.7 SD Sioux Falls	6/12			1031 KTAV	92.1 IA Knoxville-Fella
		1935 KESO	88.3 SD Brookings				1039 ????	92.1 WI Mauston
		1938 KQAD	100.9 MN Luverne				1040 KRNA	93.5 IA Iowa City
		1945 KUSD	89.7 SD Vermillion				1043 WSCD	92.9 MN Duluth
		1950 WIAL	94.1 WI Eau Claire				1048 WAXX	98.9 MN Duluth, "Wax"
		1950 KLFD	95.3 MN Litchfield				1054 ????	97.1 MI Escabana

Mike Bugaj report - continued.		7/4	Es	1338	KVLR	95.3	MN	Detroit Lakes				
6/12	Es	1059	WWSA	89.9	WI	Brule	1346	KPNW	97.9	ND	Fargo	
		1100	WNBX	93.5	MI	Newberry	1358	KFJM	89.3	ND	Grand Forks	
		1107	KCII	95.3	IA	Washington	1400	KIDA	99.9	MN	Moorhead	
		1110	KLTR	101.7	IA	Creston	1405	WKLK	100.9	MN	Cloquet	
		1130	EGOR	99.9	NE	Omaha	1408	CHIQ	94.3	MB	Winnipeg	
		1130	KFOR	102.7	NE	Lincoln	1720	KTLB	105.5	IA	Twin Lakes	
		1133	KLIF	100.3	IA	Des Moines	1742	KFTR	92.9	ND	Bismarck, T93	
		1134	KJSK	101.1	NE	Columbus	1750	KMWF	96.7	MN	Rochester, "Quick"	
		1140	KQKQ	98.5	IA	Council Bluffs, KQ98	1800	KCHF	93.5	SD	Sioux Falls	
		1223	KBRX	92.7	NE	O'Neill	1810	KDCM	94.3	MN	Windom	
6/16	Tr	1830	WGSB	99.9	NY	Plattsburg	1816	WJMI	99.7	MS	Jackson	
6/18		1705	WDSB	94.7	DE	Dover	1820	WKBB	100.8	MS	West Point	
6/19	Es	2100	WAQT	94.1	AL	Carrollton	1821	WHAY	105.5	MS	Aberdeen	
6/20		1815	WRYO	98.5	FL	Crystal River	1825	WRJH	97.7	MS	Brandon, gospel	
		1820	KOTN	92.3	AR	Pine Bluff	1855	WHIC	94.3	KY	Hardensburg	
		1850	KKYK	103.7	AR	Little Rock, K-Kick	1900	KQMR	100.3	AR	Jacksonville	
6/21		2000	KMTX	97.5	TX	Waco	1725	KHKB	101.7	TX	??	
6/26		2002	WCMQ	92.1	FL	Hialeah, SS	1729	WLEB	96.9	IL	Matoon	
6/30		1810	KMRJ	96.9	KS	Pittsburg	1730	WKKB	92.1	WI	Manitowoc	
		1812	KRMS	93.5	MO	Osage Beach	1735	WDOR	93.9	WI	Sturgeon Bay	
		1814	KCLO	98.9	KS	Leavenworth	1743	WERL	94.3	WI	Eagle River	
		1815	KOUR	95.3	IA	Independence	1804	WPRL	98.5	IL	Freeport	
		1825	KTFC	103.3	IA	Sioux City	1806	WCOG	98.7	IA	Centerville	
		1828	WFMB	104.5	IL	Springfield	1806	WISM	98.1	WI	Madison	
		1830	KLEM	99.5	IA	LeMans	1809	WLSN	97.3	WI	Milwaukee	
		1840	WNWC	102.5	WI	Madison	1815	WWRM	92.1	FL	W. Palm Beach	
		1843	KJAN	103.7	IA	Atlantic	1925	WGOV	92.9	GA	Valdosta	
		1847	KUDL	98.1	KS	Kansas City	1958	WGWG	88.3	NC	Boiling Spring	
		1855	KLSS	106.1	IA	Mason City	2000	WDYN	89.7	TN	Chattanooga	
		1910	KDPS	88.1	IA	Des Moines	2030	WFPK	91.9	KY	Louisville	
		2043	KJMO	100.1	MO	Jefferson City, J100	2038	WMTS	96.3	TN	Murfreesboro	
		2044	KERA	97.9	KS	Wichita	2046	KEZK	102.0	MO	St. Louis	
		2059	WQUD	104.5	TN	Memphis	2050	WAKO	101.1	KY	Russellville	
		2100	WNJC	90.1	MS	Senetobia	2100	WDDD	107.3	IL	Marion	
		2104	WATO	98.7	MO	Springfield	2131	WEDC	100.9	IN	Huntingburg	
		2110	KTCS	99.9	AR	Pt. Smith	7/11 Tr	1943	WDVL	92.1	NJ	Vineland, V92
		2115	KVEE	105.1	AR	Conway	7/12 Es	1947	KJLS	103.3	KS	Hays
		1732	WQXQ	101.9	FL	Daytona Beach	1958	KOAX	105.3	TX	Dallas, "Coax"	
		1755	WUSF	89.7	FL	Tampa	2000	KLOQ	106.1	KS	Lyons	
		1804	WTNR	101.5	GA	Brunswick	2105	KYLC	100.3	TX	Dallas (KMEZ-fjn)	
		1815	WQHL	98.1	FL	Live Oak	2016	KVIL	103.7	TX	Dallas	
		1827	WDEN	105.3	GA	Macon	2017	KUGB	104.3	KS	Great Bend	
		1830	WPGA	100.9	GA	Perry	2018	WGOT	106.3	MS	Meriton	
		1845	WVRG	99.9	AL	Mobile	2026	KMKF	101.7	KS	Manhattan	
7/3	Gw	1100	WUSB	90.1	NY	Stoney Brook	2031	KSKG	99.9	KS	Salina	
	Es	2030	WMPM	92.1	WI	Menomonie	2042	KRNY	98.9	NE	Kearney	
		2043	WMBE	92.9	NE	Beatrice	2047	KWKI	93.3	MO	Kansas City	
		2045	KSJM	93.3	ND	Jamestown	2106	KOOO	104.5	NE	Omaha	
		2100	KMOE	92.1	MO	Hutler	2110	KYYY	96.9	NE	Seward (KSRD-fjn)	
		2100	WNRQ	92.1	MS	Brookhaven	7/14 Tr	2205	CJCM	88.7	ON	Windsor
7/4		1300	WRLS	92.1	WI	Hayward	2230	WPMI	99.7	OH	Columbus, \$	
		1301	KQWB	98.7	MN	Moorhead	2246	WREB	97.1	OH	Astabula	
		1305	KPRM	103.7	MN	Park Rapids	2250	WCLW	105.3	OH	Mansfield, \$	
		1320	KEHP	101.1	MN	Demidji	2310	WVST	104.5	OH	Wooster, \$	
		1323	KRAD	103.9	MN	E. Grand Rapids	7/15	0458	WVWK	97.3	WV	Wheeling, o/WHP

Eric Feder - 23-35 Bell Blvd - Bayside, NY (ELT)

Eq: Concord CR-260 Stereo, Bowtie antenna. Log totals: 167, 11 states + DC. New underlined.													
4/21	Tr	0126	WRVQ	94.5	VA	Richmond (300)	6/1	Tr	0235	WCRB	102.5	MA	Waltham, \$ classical
		0158	WRFY	102.5	PA	Reading			0239	WTIC	96.5	CT	Hartford, "96-ticks"
5/8	Gw	0005	WLVI	93.7	CT	Hartford, SS music			0242	WSRS	96.1	MA	Worcester, L&C
5/12		1300	WRKI	95.1	CT	Brookfield			0300	WTKK	100.7	MA	Boston, "TK-101"
5/22	Tr	2130	WCCB	94.9	MA	W. Yarmouth (200)			0317	WCGY	93.7	MA	Lawrence
6/1		0128	WVBF	105.7	MA	Framington			0335	WUHU	91.3	CT	W. Hartford
		0200	WBEU	90.9	MA	Boston, \$ (175)	6/2		1559	WWRJ	95.3	NY	Southampton
		0225	WEEI	103.3	MA	Boston, CBS prog.			1630	WCOZ	94.5	MA	Boston, \$ Prog, rock
		0233	WAQY	102.1	MA	Springfield, "Wacky" 6/9			0200	WVLC	104.7	MA	Orleans, CBS, \$(210)



FM DX NORTH

September 1977

Eric Fader report - continued.

6/17 Tr 0045 WCHR 94.5 NJ Trenton  
 0100 WUHY 90.9 PA Philadelphia, s/off  
 0105 WCAU 98.1 PA Philadelphia, rock  
 0212 WIOQ 102.1 PA Philadelphia, "Q"  
 0222 WMGK 102.9 PA Philadelphia, magic  
 0225 WMGM 103.7 NJ Atlantic City, rock  
 0240 WRCP 104.5 PA Philadelphia, k  
 0242 WAMU 88.5 DC Washington  
 0245 Philadelphia stations (93.3, 94.1)  
 0252 WUSL 98.9 PA Philadelphia  
 0308 WJZR 100.1 NJ Shipbottom, rock  
 0312 WFMZ 100.7 PA Allentown

6/24 Tr 0106 WQQQ? 99.9 PA Easton, WEZN off  
 1920 WLNG 92.1 NY Sag Harbor  
 2001 WRDR 104.9 NJ Egg Harbor  
 0305 WHIM 94.1 RI Providence  
 6/26 0105 WEZV 95.1 PA Bethlehem  
 6/28Gw 0115 WUSB 90.1 NY Stonybrook  
 Tr 0130 WBQC 104.7 MD Ocean City, L&C  
 0135 Relogs; PA NJ DE MD DC stations  
 7/11 2300 WKXW 104.1 PA Allentown  
 0055 WPLM 99.1 MA Plymouth, s/off  
 0106 WGRF? 99.3 NJ Pleasantville  
 0145 ???? 89.7 \$ carrier - WGBH?  
 73 - - Eric.

Joseph Fela - 150 Robert Place - So. Plainfield, NJ 07080 (ELT)

RX; Pioneer SX-828. Ant: Pair of Antennacraft GFM-10s (stacked). Rotor. Underlined are new.

6/20 Es  
 1842 KISR 93.7 AR Ft. Smith, rock  
 6/21 Es  
 1925 KROZ 92.1 TX Tyler, k, "Rose of Tyler"  
 1930 KSUC 88.3 TX Keene, ID, religious  
 1940 ???? 92.1 Who had Astros BB? Not KROZ  
 1959 KETR 88.9 TX Commerce, council meeting  
 2002 KCEI 89.3 TX Dallas  
 2014 KOAY 105.3 TX Dallas, EL, PSAs  
 2019 KESS? 93.9 TX Dallas, SS (KESS is SS-fn)  
 2024 KJRM 96.7 TX Sherman, briefly w/ID  
 6/24 Tr  
 2000-2300 to SE New England. WRLM-93.3, etc.

7/3 Es  
 1056 WINZ 94.9 FL Miami, rock, ads, ID  
 1059 WHRS 91.7 FL Boyton Beach, ID, mixing  
 w/Spanish. Ideas?  
 2006 KERA 90.1 TX Dallas, ID, thn NPR stuff  
 2011 KROZ 92.1 TX Tyler, country, ID  
 2042 KKDA 104.5 TX Dallas, s, lcl wx, K-104  
 2048 KCTR? 107.9 TX Corsicana, Texas P&L ad  
 7/4 Es  
 1300-1400 CKY 92.1 MB Winnipeg, L&C, EL, IDs  
 1303 KFJM 89.3 ND Grand Forks, ID, EBS test  
 1337 KKDQ 92.9 ND Grand Forks, "KDQ", rock  
 1350 CJSJ 94.3 ON Thunder Bay, EL

6/30 Es  
 1831 WIAL 94.1 WI Eau Claire, ads, weather  
 1853 KWQA? 95.1 MN Worthington, "\$-95"  
 1900 KSTP 94.5 MN St. Paul, KS-95, IDs  
 1950 WRLS 92.1 WI Hayward, WRLS report"  
 2100 KRAV 96.1 OK Tulsa, rock, ID  
 2105 KKMA 104.5 OK Pryor, ID, ABC/I NX (A1)  
 7/1 Es  
 1905 ZEM 89.1 EM Hamilton, Hit Parade, IDs  
 1921 ZFB? 94.9 EM Hamilton, lcl ads, no ID  
 1929 WFLN 95.3 FL Apopka, L&C, religion, ID  
 1933 WAMR 92.1 FL Naples, NX, wx, ID  
 1942 WPCV 97.5 FL Winter Haven, country, IDs  
 1959 WLOQ 103.1 FL Winter Park, ID, classical  
 2000 WQSR 102.5 FL Sarasota, legal ID, rock  
 7/2 Es  
 1805 WFUZ 93.7 FL Ocala, ID, marine weather  
 1811 WATV 96.9 FL Jacksonville, "Wave-97", r  
 1821 WPFM 107.9 FL Panama City, IDs, rock  
 1832 WQ?? 98.5 FL Panama City, EL(not WONE)  
 1838 WBTR 92.1 GA Carrollton, SID  
 1856 WJGA 92.1 GA Jackson, AM/PM ID  
 1859 WOAB 104.9 AL Ozark, ads, ID  
 1900 WAJB 107.3 FL Pensacola, ID, lcl weather  
 Will hold the rest to next month - - 73, Joe. (Nice going on that Puerto Rico catch - fn)

7/6 Es  
 1155 WCTE 91.3 FL Lakeland, NX, ID, briefly  
 1226 WRGI 93.5 FL Naples, ex- WALJ  
 1916 KMFL 102.9 MO Marshall, ID  
 1929 WPLN 90.3 TN Nashville, ID, NPR  
 1929 WJNC 91.1 MS Senatobia, ID, NPR  
 7/7 Es  
 1207-1310 WJPR 91.3 Sarv Juan, P.R. in SS.  
 Good taped IDs at 1230 and 1300.  
 Wx in EE at 1302. My best Es (1600)  
 1344 WWRN 92.1 FL W. Palm Beach, ID  
 1359 WVOG 99.9 FL Boca Raton, ID  
 1400 WEEJ 101.1 FL Port Ch rlotte, ID, EL, ads  
 1413 WFAM 91.1 FL Jacksonville, ID  
 1420 WSMN 93.5 FL Belle Glade, ID, WGXL QRM  
 1700 WNDU 90.1 MI Marquette, NX, wx, ID, NPR  
 1701 WGGJ 92.1 MI Houghton, ID  
 1716 CKTI 92.1 ON Timmins, EL, ID, promo  
 1730 KWTR 93.7 SD Winner, ID, This is a pest.  
 1812 UNID 93.5 FFe - Is Kenora? Winnipeg  
 Ch. 6 in at this time.  
 1907 CBV? 95.3 PQ Quebec City. Other PQ's in.  
 2000 WEAJ 88.9 MD Baltimore, soul, regular  
 2200 WMPD 104.7 MD Hagerstown, ex-WJEJ, EL

Steve West - 432 Kermore Road - Haverstown, PA 19083 (Phone: 1-215-449-1472)

6/5 Es  
 1700 WDBR 103.7 IL Springfield (775)  
 WRTL 95.3 IL Rantoul (675)  
 KDKD 95.3 MO Clinton (1000)  
 WIEW 97.3 KS Topeka, auto-rock (1080)  
 6/6 Es  
 1700 KXXY 96.1 OK Oklahoma City (1250)  
 KWEN 95.5 OK Tulsa, m (1150)  
 WFRL 98.5 IL Freeport (790)  
 KOER 95.3 IA Independence (875)  
 KMOE 92.1 MO Butler, "K-Moe Radio"  
 KCPO 98.5 OK Tulsa (1150)

6/6 Es  
 1700 KQWB 98.7 MN Moorhead (1180)  
 KMHL 100.1 MN Marshall (1090)  
 KQKQ 98.5 IA Council Bluffs (1090)  
 WCTS 100.3 MN Minneapolis (990)  
 WALT 97.1 MS Meridian (900)  
 WKZY 97.1 ?? ?  
 KWLR 95.3 MN Detroit Lakes (1080)  
 KXXX 100.3 KS Colby, KC BB (1350)  
 2100 KFTR 92.9 ND Bismarck (1350)  
 6/8 Es  
 0900 WKSJ 94.9 AL Mobile (960)

FM DX NORTH

September 1977

Steve West report - continued.

6/8 Es

0900 WCKW 92.3 LA Laplace (1100)  
 KQKI 95.3 LA Bayou Vista  
 KTDY 99.9 ?? ?  
 WCGO 95.3 ?? ?  
 KO77 94.9 "KO-95"

6/14 Es

1330 KARC 92.9 OK Tulsa, auto rock, KC93  
 KOEZ 92.3 KS Newton, m (1200)  
 KBID 92.9 TX Wichita Falls (1350)  
 KDKD 95.3 MO Clinton (1000)  
 KGNO 95.5 KS Dodge City, m (1340)  
 1500 WELX 92.9 AL Mobile (960)  
 KGNO 95.5 KS Dodge City (1340)

6/16 Tr

2000 WELI 106.1 NY Patchogue (120) WWSH off  
 WPDH 101.5 NY Poughkeepsie (150)

6/21 Es (At Roanoke Rapids, NC w/Tom Yingling)

2100 KNUS 98.7 TX Dallas (1120)  
 KBRA 97.9 KS Wichita (1080)  
 KOEZ 92.3 KS Newton (1080)  
 KTSJ 98.5 ?? Farmington  
 KCFO 98.5 OK Tulsa (1150)  
 KWTO 98.7 MO Springfield (1080)  
 KMRJ 96.9 KS Pittsburg (950)  
 KICT 95.1 KS Wichita (1090)  
 KBID 92.9 TX Wichita Falls (1190)

6/22 Tr (Back home)

2100 WMZQ 98.7 DC Washington, k (130)

6/30 Es

1800 KWBE 92.3 NE Beatrice (1100)  
 KCTI 95.3 IA Washington (880)  
 KLYP 100.3 IA Des Moines, m (860)  
 KCOG 98.7 IA Centerville, gospel (940)  
 KQWB 98.7 MN Moorhead (1190)  
 KWTO 98.7 MO Springfield (990)  
 KSLI 96.9 LA Alexandria (1120)

7/6 Es

1920 WHOP 98.7 KY Hopkinsville (700)  
 KCKW 92.3 LA Laplace  
 WMRQ ?? ?  
 KXLA ?? AR Little Rock, News Radio 96  
 WAQK 101.1 KY Russellville, KQ101, rock

7/7 Es

1330 ZEM 89.1 EM Hamilton, auto rock  
 1340 ZFB 94.9 EM Hamilton, auto MoR  
 1350 WINZ 94.9 FL Ft. Lauderdale (950)

Eqt: Heathkit AR-15, Stereoprobe 9, CDR AR-10 rotor. The FM DX has been good with a lot of relogs and new ones. Receiving Bermuda is nice. This year my furthest FM has gone from Lawton, OK (last year) to Bismarek, ND to Colby, KS and finally to San Antonio, TX (1550) Also I set a record for my shortest FM Es from Rumsford, ME at 450 miles. (It may be a club record. Can anybody beat it? - fjn)

Harry J. Hayes - Star Route - Box 226c - Gouldsboro, PA 18424 (EDT)6/5 Es

0949 WFLA 93.3 FL Tampa

6/6 Es

1030 WQID 93.7 MS Biloxi  
 1758 WWJO 98.1 MN St. Cloud, "\$-98"  
 1759 KIOV 104.7 IA Sioux City  
 1800 KIDA 99.9 MN Moorhead  
 1805 KSTP 94.5 MN St. Paul, "KS-95"  
 1810 KQWB? 98.7 MN Moorhead, "Q-98"  
 1825 WALT 97.1 MS Meridian  
 1830 WAlA 97.3 FL Miami, L&C  
 1831 WMDX 96.3 FL Miami, L&C  
 1840 WOVV? 95.5 FL Ft. Pierce, "0-95"  
 1845 WABB 97.5 AL Mobile

7/7 Es

1400 KEZQ 94.1 AR Little Rock (1000)  
 1700 CFTI 92.1 ON Timmins (750)  
 WRUM 96.3 ME Rumsford (450)  
 WDUZ 98.5 WI Green Bay (780)  
 WQDY 92.7 ME Calais (560)

7/11 Tr

2130 WROR 98.5 MA Boston (275)  
 WLMG 92.1 NY Sag Harbor, rock (175)  
 WRCH 100.5 CT New Britain, m (175)

7/12 Es

1800 KWBE 92.9 NE Beatrice (1110)  
 KLYF 100.3 IA Des Moines (950)  
 KQWB 98.7 MN Moorhead (1190)  
 KWTO 98.7 KS Topeka (1080)  
 KSLI 96.9 LA Alexandria (1120)

7/14 Tr

2330 WGLL 98.5 OH Cleveland (350)  
 CKTB 97.7 ON St. Catharines (300)  
 WDMT 107.9 OH Cleveland (350)  
 WOMP 100.5 OH Bellaire (300)  
 WABZ 97.5 OH Akron (350)  
 WPMMS 100.7 OH Cleveland (350)

7/15 Tr

2230 WROR 98.5 MA Boston (250)

7/29 Es

1830 KITY 92.9 TX San Antonio (1500)

7/31 Es

1600 KSRD 96.9 NE Seward (1130)  
 KLOH 98.7 MN Pipestone (1160)

8/3 Es

1830 KGOR 99.9 NE Omaha (1080)  
 KJAW 103.7 IA Atlantic (1040)  
 KWTO 98.7 KS Topeka (1100)  
 1900 KLFQ 95.3 IA Iowa Falls (850)  
 KWEN 95.5 OK Tulsa (1150)  
 KSEZ 97.9 IA Souix City, Rock-98 (1100)  
 KCFO 98.5 OK Tulsa (1150)  
 KSCM 99.3 MO Houston (920)  
 KGGO 94.9 IA Des Moines (960)  
 WTBW 97.3 KS Topeka, auto rock (1090)  
 KOEZ 92.3 KS Newton (1200)  
 WFAI 100.5 IL Jacksonville, auto rock  
 KSRD 96.9 NE Seward (1130)  
 KLYF 100.3 IA Des Moines (960)  
 WKAI 100.1 IL Macomb (810)  
 WJAG 106.7 NE Norfolk (1150)  
 KLIN 107.3 NE Lincoln (1120)

6/6 Es

1850 WKSJ 94.9 AL Mobile, country music  
 1900 KPFL 99.9 LA Lafayette  
 1933 WDAY 93.7 ND Fargo, Easy Listening music  
 1935 KVLR 95.3 MN Detroit Lakes, SID  
 1935 WSCD? 92.9 MN poking thru WZZZ  
 2000 KACH 94.9 MN Duluth, "KO-95", country mt  
 2000 WDTN 103.3 MN Duluth, classical music, ID  
 2000 WGRR 105.1 MN Duluth, station ident.  
 2005 Unid 101.1 "The entertainer" KBHP?

6/9 Es

1330 KMOT 93.7 ND Minot, (1330)

6/12 Es

1228 KIJV 92.1 SD Huron, thru WMJW



FM DX NORTH

September 1977

Harry J. Hayes report - continued.		7/6	Es	1908	<u>KMRJ</u>	96.9	KS	Pittsburg, "twin/				
6/12	Es	1230	<u>KLSE</u>	91.7	MN	Rushford	1922	<u>WALT</u>	97.1	MS	Meridian	giants"
6/20	Tr	2100	<u>WRTI</u>	90.1	PA	Philadelphia, AI	7/7	1400	<u>WMCU</u>	89.7	FL	Miami, Mutual News
6/21	Es	2010	<u>KROK</u>	94.5	LA	Shreveport	1401	<u>WAFG</u>	90.3	FL	Ft. Lauderdale	
		2012	<u>KYKY</u>	105.7	TX	Longview, SID	1447	<u>ZEM</u>	89.1	EM	Hamilton	
		2126	<u>KRLY</u>	93.7	TX	Houston	1500	<u>ZFB</u>	94.9	EM	Hamilton	
6/26		1900	Unid	89.3	Talk, PTA: AR or TN		1852	Unid	93.5	FFc.	CBIM? TV was	
6/30		1840	<u>KFMQ</u>	101.9	NE	Lincoln, ID					into PQ.	
		1900	<u>KSTP</u>	94.5	MN	St. Paul	2021	<u>WDIZ</u>	100.3	FL	Orlando	
		1900	<u>KLWA</u>	105.5	IA	Sheldon, ID	7/26	1941	<u>KMGK</u>	93.3	IA	Des Moines
		1905	<u>WJMC?</u>	96.3	WI	Rice Lake	2020	<u>KCII</u>	95.3	IA	Washington, L&C	
		1912	Unid	93.5	SD	mentioned	2020	<u>KSRD</u>	96.9	NE	Seward, SID, rock	
		2045	<u>KOEZ?</u>	92.3	KS	Newton	2044	<u>KXCV</u>	90.5	MO	Maryville, ID	
		2055	<u>KREB</u>	95.9	OK	Sallisaw	2100	<u>KLUM</u>	88.9	MO	Jefferson City, j	
		2120	<u>KKYK</u>	103.7	AR	Little Rock	2105	<u>KCMW</u>	90.9	MO	Warrensburg, 1cl wx	
7/1		1749	<u>WAXY</u>	105.7	FL	Ft. Lauderdale	2129	<u>KUMR</u>	88.5	MO	Rolla, IDs	
		1758	<u>WGLO</u>	106.7	FL	Ft. Lauderdale	2131	<u>KSMU</u>	91.1	MO	Springfield, L&C	
7/3		2049	<u>KWTX</u>	97.5	TX	Waco, EL wx	7/29	1915-1945	93.9	NF	St. Johns, assumed	

The 93.9 station heard during the 7/29 opening must be the 100Kw station listed in Mark Lewis' Feb. VUD column. However, this station played mostly recent hits from "heavy" groups like "Yes", "Queen", etc., not T-40. Definitely from Maritimes as time 1 1/2 hr ahead. No ID heard. Is there any ID? Sounded like annr said "Radio I". I assume this was the station with a TT on 6/2 opening from this area. Totals: 422. 73 -- Harry.

Paul D. Traska - 64 Weaver Ave. - Buffalo, NY 14206

Totals: 171, 21 states, DC, 67 Educ., 3 prov., and 1 foreign.		All New stations, except ZEM.											
7/7	Es	1605	<u>ZEM</u>	89.1	EM	Hamilton	7/14	Tr	1230	Unid	95.5	ON	FFc (CJEC-17 -fjn)
		1700	<u>CJOB</u>	97.5	MB	Winnipeg	1315	<u>WCLV</u>	95.5	OH	Cleveland		
		1730	<u>WMEA</u>	90.1	ME	Portland	1430	<u>CIGM</u>	92.7	ON	Sudbury, ex-CKSO		
7/12		1930	<u>KKRL</u>	89.1	PQ	Quebec	7/18	1330	<u>WPIT</u>	101.5	PA	Pittsburgh	
		2017	<u>KOEZ</u>	92.3	KS	Newton	7/24	1736	<u>CFBY</u>	102.1	ON	Brampton, ex-CHIC	
		2058	<u>KRAV</u>	96.5	OK	Tulsa	7/31	Es	1828	<u>KBFL</u>	90.3	MO	Buffalo
		2058	<u>KMOD</u>	97.5	OK	Tulsa	1914	<u>KGOW</u>	92.1	OK	Broken Arrow		
		2059	<u>KJAK</u>	100.5	OK	Oklahoma City	2030	<u>KLJC</u>	88.5	MO	Kansas City		
		2100	<u>KICT</u>	95.1	KS	Wichita	8/3	1800	<u>WIEB</u>	97.3	KS	Topeka	
		2130	<u>KXXK</u>	100.3	KS	Colby	1830	<u>KCMW</u>	90.9	MO	Warrensburg		
7/13	Tr	2355	<u>CKNX</u>	101.7	ON	Wingham	1845	<u>XSKU</u>	102.1	KS	Hutchinson		
7/14		1145	<u>WHCU</u>	97.3	NY	Ithaca	1915	<u>KMKF</u>	101.7	KS	Manhattan		

Frank Wheeler - 6589 Wattsburg Road - Erie, PA 16509

Eq: Receiver - Panasonic Table Model RE 7329, Antenna - Archer VU160 VHF-UHF-FM.													
6/15	Tr	0802	<u>WRVO</u>	89.5	NY	Oswego (195)	7/14	Tr	1030	<u>WHSB</u>	107.7	MI	Alpena (267)
6/26		0202	<u>WXXI</u>	91.5	NY	Rochester (143)	7/20	1230	<u>WNED</u>	94.5	NY	Buffalo (82)	
		0212	<u>WDET</u>	101.9	MI	Detroit (154)	7/14	1000	<u>CINB</u>	107.9	ON	Burlington	
7/15		0856	<u>WVIA</u>	89.9	PA	Scranton (225)	7/20	0000	<u>CKO</u>	99.1	ON	Ottawa (313)	

Bob Seybold - Bennett Road - Dunkirk, NY 14048

The following is a report for May & June. FM DXing - - mostly of E-skip variety.													
5/7	Es	1915	<u>WQUE</u>	93.3	LA	New Orleans	5/30	Es	1800	<u>KOSU</u>	91.7	OK	Stillwater
		1948	<u>WRNO</u>	99.5	LA	New Orleans	6/2	2030	<u>WINZ</u>	94.9	FL	Miami Beach	
		2050	<u>WHYI</u>	100.7	FL	Ft. Lauderdale	2032	<u>WVOG</u>	99.9	FL	Boca Raton		
		2057	<u>WGYL</u>	93.5	FL	Vero Beach	0830	<u>KMRJ</u>	96.9	KS	Pittsburg		
5/8		1935	<u>KGOW</u>	92.1	OK	Broken Arrow	0915	<u>WUSF</u>	89.7	FL	Miami		
		1958	<u>KYKR</u>	93.3	TX	Port Arthur	0915	<u>WAXY</u>	105.9	FL	Ft. Lauderdale		
		2020	<u>KRLY</u>	93.7	TX	Houston	1000	<u>WVFM</u>	94.1	FL	Lakeland		
5/29		1105	<u>KAFM</u>	92.5	TX	Dallas	1015	<u>WVWL</u>	93.9	FL	Miami Beach		
		1130	<u>KJAK</u>	100.5	OK	Oklahoma City	1015	<u>WKGZ</u>	90.7	FL	Panama City		
		1210	<u>KAKC</u>	92.9	OK	Tulsa	1600	<u>WHFI</u>	94.1	MS	Jackson		
		1230	<u>KEZO</u>	92.3	NE	Omaha	1615	<u>WRNO</u>	99.5	LA	New Orleans		
		1230	<u>KEBC</u>	94.7	OK	Oklahoma City	1615	<u>WQUE</u>	93.3	LA	New Orleans		
		1248	<u>KMEZ</u>	100.3	TX	Dallas	1700	<u>WZZK</u>	104.7	AL	Birmingham		
5/30		1600	<u>WCAL</u>	89.3	MN	Northfield	1705	<u>WHER</u>	103.7	MS	Hattiesburg		
		1615	<u>KDLO</u>	96.9	SD	Watertown	1714	<u>KTTT</u>	93.5	NE	Columbus		
		1615	<u>KLXX</u>	96.1	SD	Watertown	1715	<u>WKSJ</u>	94.9	AL	Mobile		
		1730	<u>KYFR</u>	92.9	ND	Bismarck	1800	<u>KPAT</u>	97.3	SD	Sioux Falls		
		1732	<u>WDAY</u>	93.7	ND	Fargo	1805	<u>KMUW</u>	89.1	KS	Wichita		
		1800	<u>KWKR</u>	93.7	SD	Winner							

Bob Seybold report - continued.  
 6/6 Es 1806 WMEZ 94.1 FL Pensacola  
 1815 KLUM 88.9 MO Jefferson City  
 1900 KTAV 92.1 IA Knoxville  
 1912 WQID 93.7 MS Biloxi  
 1915 KHOO 99.9 TX Waco  
 2000 KYND 92.3 TX Pasadena  
 2001 KAWY 94.5 WY Casper  
 2005 KVSF 97.9 SD Rapid City  
 2015 KNEB 94.1 NE Scottsbluff

A great many more logged on this super day, but too many to list.  
 6/13 1730 KESC 90.1 OK Edmond  
 1745 KWGS 89.5 OK Tulsa  
 1748 KSNS 96.1 LA Lake Charles  
 1800 KERT 96.5 LA Shreveport  
 1801 KRND 101.1 LA Shreveport  
 1815 KMIT 105.1 TX Abilene  
 1816 KLEK 94.5 TX Lubbock  
 1825 KSEL 93.7 TX Lubbock  
 1830 KIOP 106.1 TX Orange  
 1845 KPAS 93.9 TX El Paso

6/14 1215 KHM 88.9 DF Mexico City, SS  
 1230 XHZM 92.5 Pue. Puebla, SS  
 1230 Unid 89.3 ?? Spanish  
 1248 KOB 93.3 NM Albuquerque  
 1259 KRKE 94.1 NM Albuquerque

Will continue report at later date. This is enough for now.

6/14 Es 1300 KWMJ 103.3 TX Midland  
 1315 KQXY 94.1 TX Beaumont  
 1316 KSTA 107.1 TX Coleman  
 1325 KTAL 98.1 TX Texarkana  
 1330 KOYL 97.9 TX Odessa  
 1340 KAMU 90.3 TX College Station  
 1400 KAFM 92.5 TX Dallas  
 1400 KIKK 95.7 TX Houston  
 1401 KCHV 90.9 TX Dallas  
 1415 KETR 89.9 TX Commerce

Another big day - too many to list all.  
 6/21 1215 KDJW 94.1 TX Amarillo  
 1230 KGNC 97.9 TX Amarillo  
 1245 KNOE 101.9 LA Monroe  
 1300 KTCU 89.1 TX Ft. Worth  
 1830 KRSM 88.5 TX Dallas  
 1845 KACW 99.3 TX Paris  
 1900 KNCT 91.3 TX Killeen  
 1900 KZFM 95.5 TX Corpus Christi  
 1100 KQSW 96.5 WY Rock Springs

6/22 1845 CHRC 98.1 PQ Quebec  
 1140 KMUW 89.1 KS Wichita  
 1145 KUPK 97.3 KS Garden City  
 1200 KLIR 100.3 CO Denver  
 1215 KOA 103.5 CO Denver  
 1215 KOST 101.1 CO Denver  
 Many others received on this date also.

Peter Sawatsky - 244 Neilson Ave - Waterloo, ON N2J 2M3 (EDT)

Eq: Receiver - Heathkit AJ-15; Antenna - Dalhi 1047 @ 30'. New loggings underlined.

6/20 Es 1924 KEEC 94.7 OK Okla. City (1045)  
 2053 KYKR 93.3 TX Port Arthur (1180)  
 2056 KIKK 95.7 TX Houston (1240)  
 2058 KODA 99.1 TX Houston  
 2059 KCOZ 100.1 LA Shreveport (1035)  
 2110 KSCS 96.3 TX Ft. Worth (1170)  
 2111 KLBV 93.7 TX Austin (1295)  
 (1st time by new CL - ex-KTEC)  
 2114 KIKS 93.3 TX Killeen (1240)  
 2117 KHOO 99.9 TX Waco (1215)  
 2120 KCSW 103.7 TX San Marcos (1330)  
 (1st time by new CL - ex-KRMH)  
 2122 KZEW 97.9 TX Dallas (1130)  
 2125 KWTX 97.5 TX Waco (1215)  
 2129 KETR 88.9 TX Commerce (1080)  
 2131 KFJZ 97.1 TX Ft. Worth (1170)  
 2133 KNAF 101.1 TX Fredericksburg  
 2140 WGEA 93.5 AL Geneva (900)  
 2142 WCUP 100.3 GA Tifton (845)  
 2144 KKAJ 95.7 OK Ardmore (1100)  
 2149 WJIZ 96.3 GA Albany (845)  
 2159 KBID 92.9 TX Wichita Falls  
 2201 KLLS 94.3 OK Okmulgee (970)  
 2205 KSEL 93.7 TX Lubbock (1350)  
 2212 KTEZ 101.1 TX Lubbock

6/21 1900 WNO 89.9 LA New Orleans (1070)  
 1930 KZZQ 94.3 LA Gold Meadow (1100)  
 1931 WBYU 95.7 LA New Orleans  
 1938 WNOE 101.1 LA New Orleans  
 1946 WQXY 100.7 LA Baton Rouge (1060)  
 1947 WMD 100.9 MS Hazlehurst (965)  
 1948 WCRW 92.3 LA La Place (1075)  
 1958 WWL 101.9 LA New Orleans (1070)  
 2002 WBSJ 102.3 MS Ellisville (945)  
 2005 WRPM 107.9 MS Poplarville (1010)  
 2007 WRNO 99.5 LA New Orleans  
 2108 WALT 97.1 MS Meridian (880)  
 2024 WQUE 93.3 LA New Orleans

6/21 Es 2032 WKTY 93.5 MS Bay Springs (925)  
 2043 KSMB 94.5 LA Lafayette (1110)  
 2047 KDEA 99.1 LA New Iberia (1115)  
 2159 WBLX 92.9 AL Mobile (970)  
 1924 WBJT 93.5 MS Clinton (925)  
 1933 KSLY 93.9 TX Corpus Christi (1420)  
 1936 KSMB 94.5 LA Lafayette (1110)  
 1711 WVOH 93.5 GA Hazlehurst (810)  
 Tr 1715 WKIQ 93.5 OH Bowling Green (215)  
 (1st time by new CL - ex-WAWR)

Es 1826 KEBM 94.9 NH Roswell (1455)  
 1828 KIVY 92.7 TX Crockett (1160)  
 1831 KMHV 93.5 OK Altus (1160)  
 1831 KLLL 96.3 TX Lubbock (1350)  
 1841 KSER 99.3 AR Searcy (825)  
 1845 KLEK 94.5 TX Lubbock (1350)  
 1856 KTEZ 101.1 TX Lubbock  
 1859 KACV 89.9 TX Amarillo (1255)  
 1905 KICT 95.1 KS Wichita (955)  
 1917 KSEL 93.7 TX Lubbock  
 1918 KEMF 98.3 TX Spearman (1195)  
 1952 KTKC 92.7 LA Springhill (1000)  
 2005 KWTX 97.5 TX Waco (1215)  
 2037 KLLS 94.3 OK Okmulgee (970)  
 2049 KSMB 94.5 LA Lafayette (1110)  
 2054 KJAT 98.3 GA Swainsboro (755)  
 2058 WALX 100.9 AL Selma (840)  
 2110 WSM 103.1 MS Ocean Springs (1000)  
 2112 WML 101.9 LA New Orleans (1070)  
 1813 KREC 94.7 OK Oklahoma City (1045)  
 1820 KSEL 93.7 TX Lubbock (1350)

Gw 1836 CRO 99.1 ON Toronto (55)  
 Es 1944 KVPI 93.5 LA Ville Platte (1085)  
 1728 KUVR 97.7 NE Holdrege (980)  
 1731 WRCO 100.9 WI Richland Center (490)  
 1732 KJSK 101.1 NE Columbus (865)  
 1733 KJAN 103.7 IA Atlantic (750)  
 (1st time by Es - prev. by MS)



**FM DX NORTH**

Peter Sawatzky report - continued.

7/4 Es	1740	KVRF	102.3	SD	Vermillion (825)
	1742	KAYL	101.5	IA	Storm Lake (740)
	1748	KCHF	93.5	SD	Sioux Falls (810)
	1750	KROA	95.7	NE	Grand Island(925)
	1753	KBCM	95.5	IA	Sioux City (800)
	1757	KCHE	102.3	IA	Cherokee (755)
	1758	KLEM	99.5	IA	Le Mars (785)
	1801	KVDB	94.3	IA	Sioux Center(785)
	1814	KLGA	92.7	IA	Algona (685)
	1816	KBMO	93.5	MN	Benson (755)
	1821	KMSR	94.3	MN	Sauk Center (725)
7/6	1845	WQXM	97.9	FL	Clearwater (1075)
	1847	WASR	102.5	FL	Sarasota (1125)
	1901	WFLA	93.3	FL	Tampa (1070)
	1902	WFUZ	93.7	FL	Ocala (985)
	1903	WVGA	100.9	GA	Waynesboro (720)
	1912	WKTY	96.1	FL	Jacksonville (910)
	1915	WFLM	97.3	GA	Savannah (785)
	1918	WPCV	97.5	FL	Winter Haven(1065)
	1920	WQXQ	101.9	FL	Daytona Bch (1050)
	1928	WCKS	101.1	FL	Cocoa Bch (1035)
	1930	WYRL	102.3	FL	Melbourne (1060)
	1935	WDIZ	100.3	FL	Orlando (1025)
7/7	1739	KFMQ	101.9	NE	Lincoln(prev. MS)
	1743	KDMI	97.3	IA	Des Moines (670)
	1753	WCIB	101.9	MA	Falmouth (515)
	1754	WXXA	98.9	ME	Brunswick (525)
	1801	WMEH	90.9	ME	Bangor (585)
	1802	WOCB	94.9	MA	W. Yarmouth (535)
	1804	WQRC	99.9	MA	Barnstable (530)
	1806	WRKD	93.5	ME	Rockland (565)
	1814	KIOZ	102.9	WY	Laramie (1280)
	1819	CHFX	101.9	NS	Halifax (830)
					(1st time on 101.9, prev. 96.1)
	1825	WODY	92.7	ME	Calais (660)
					(most Easterly FM sta. in US)
	1842	WRON	100.9	ME	Westbrook (505)
	1846	WDEA	95.7	ME	Ellsworth (600)
	1900	CEC	96.9	PEI	Charlottetown
					(Rcvd at 7pm on the 7th day of
					the 7th month of the 77th yr
					of the century!!!)
	1903	WBGW	97.1	ME	Bangor (585)
	1911	CBPD	96.5	PQ	St. Fabien(7/18)
	1912	CEZF	102.3	NB	Grand Manan (680)
	1915	CBIM	93.5	PQ	Ile de la Mad.(945)
	1918	WPBC	92.9	ME	Bangor (585)
	1919	WDHP	96.9	ME	Presque Isle(645)
	1922	WFST	97.7	ME	Caribou (650)
	1931	WUPK	90.3	ME	Fort Kent (630)
					(10w11 - Received QSL)
	1934	WHAU	92.5	MA	Haverhill (470)
					(my closest Es to date)
7/8 Tr	1935	WQXO	92.7	ME	Norway (495)
	0740	WFMS	95.5	IN	Indianapolis (380)
	2202	WFCM	97.9	WV	Fairmont (275)
7/9	0725	WRCI	93.5	MI	Midland (185)
	0740	WZZM	95.7	MI	Grand Rapids (260)
7/12 Es	1849	ZEM	89.1	Bermuda	(1140)
	1940	WCKW	92.3	LA	La Place (1075)
	1947	KYND	92.5	TX	Pasadena (1240)
	1950	WTGI	103.3	LA	Hammond (1045)
	1951	KGRA	103.7	LA	Lake Charles(1145)
	1959	WQXY	100.7	LA	Baton Rouge (1060)
	2005	KJNA	99.3	LA	Jena (1030)
	2010	WZZQ	102.9	MS	Jackson (925)
	2017	WKYV	106.7	MS	Vicksburg (955)

**September 1977**

7/12 Es	2020	KQUE	102.9	TX	Houston (1240)
	2025	WYNK	101.5	LA	Baton Rouge (1060)
	2029	KCLC	89.1	MO	St. Charles (610)
	2229	KJSK	101.1	ME	Columbus (865)
	2029	KMUW	89.1	KS	Wichita (955)
	2031	KSMU	91.1	MO	Springfield (790)
	2041	KLGL	101.1	TX	Houston (1240)
	2046	KEZU	103.1	AR	El Dorado (955)
					(1st time by new CL - ex-KELD)
	2047	KPCG	102.5	MO	Joplin (855)
	2048	KJAK	100.5	OK	Okla. City (1045)
	2058	KLUM	88.9	MO	Jeff. City (690)
	2105	KOPM	104.1	OK	Okla. City
	2110	KMMM	106.9	OK	Muskogee (945)
	2116	KVGB	104.3	KS	Great Bend (1010)
	2122	KVIL	103.7	TX	Dallas (1130)
	2125	KNDY	103.1	KS	Marysville (860)
	2127	KLIN	107.3	NE	Lincoln (850)
	2128	KARD	107.3	KS	Wichita (955)
	2035	WLSY	99.3	AL	York (865)
	2039	KSCM	99.3	MO	Houston (730)
	2111	KSKU	102.1	KS	Hutchinson (975)
	2144	KRBE	104.1	TX	Houston (1240)
	2149	KKXX	100.3	KS	Colby (1090)
	2156	WQUE	93.3	LA	New Orleans (1070)
	2218	WOOF	99.7	AL	Dothan (880)
	2220	KRVN	93.1	NE	Lexington (990)
	2222	KESS	93.9	TX	Fort Worth (1170)
	2228	KLXY	94.7	TX	San Angelo (1350)
	2229	KFGQ	99.3	IA	Boone (680)
	2245	KEBD	92.9	TX	Wichita Falls(1165)
	2250	WPAP	92.5	FL	Panama City (955)
	2255	WGEA	93.5	AL	Geneva (900)
	2257	WFUS	91.5	FL	Tallahassee (920)
	2304	KCSG	90.1	OK	Edmond (1070)
7/14 Tr	2245	CKO	106.9	ON	Ottawa (265)
					(Same CL as CKO 99.1 Toronto, yet
					weather was local)
	2332	WMRT	88.3	OH	Marletta (285)
	2356	WVPE	91.7	WV	Beckley (395)
	2359	CECK	107.5	ON	Kigleton (200)
	0012	WBKW	99.5	WV	Beckley (395)
	0021	WVWR	89.1	VA	Roanoke (430)
	0732	WSKG	89.3	NY	Binghamton (245)
	1730	WVPE	88.1	IN	Elkhart (300)
7/22 Es	1800	WAFG	90.3	FL	Ft. Lauderdale
	1808	WHEU	89.7	FL	Miami (1205)
	1827	WLYF	101.5	FL	Miami
	1829	WLRN	91.3	FL	Miami
	1832	WCKS	101.1	FL	Cocoa Bch (1035)
	1835	WXOS	100.3	FL	Plantation Key
	1838	WMLX	96.3	FL	Miami (1205)
	1839	WEDR	99.1	FL	Miami
	1841	WCKO	102.7	FL	Pompano Bch (1190)
	1842	WGLO	106.7	FL	Ft. Lauderdale
	1853	WALA	97.3	FL	Miami
	1858	WTMI	93.1	FL	Miami
	1900	WNUM	94.3	FL	Marathon (1290)
	1907	WMCF	92.7	FL	Stuart (1115)
	1929	WINZ	94.9	FL	Miami Bch (1205)
	1935	WPCV	97.5	FL	Winter Haven(1065)
	2115	WTCQ	97.7	GA	Vidalia (785)
	1821	KCFR	90.1	CO	Denver (1270)
	1825	KPIK	93.9	CO	Colorado Sprgs
	1834	KMOT	93.7	ND	Minot (1050)
	1848	KKKX	95.7	CO	Denver (1270)
	1851	KSPZ	92.9	CO	Colo. Springs(1285)
	1858	KDSU	91.9	ND	Fargo (825)

Peter Sawatzky report - continued.

<u>7/26 Es</u>	<u>7/27 Es</u>
1905 KCGM 95.7 MT Scobie (1240)	2133 WAYD 103.9 AL Ozark (875)
1905 KIVE 96.5 MT Glendive (1195)	2137 WKLH 92.3 AL Montgomery (830)
1908 CBKF 97.7 SA Regina (1235)	2140 WXEM 102.7 FL Milton (955)
1910 CBFT 97.9 MB Brandon (1035)	2143 WQID 93.7 MS Biloxi (1000)
(See Feb. 77 VUD - What are CL?)	2150 WBOP 101.5 FL Pensacola (980)
1912 KPNW 97.9 ND Grand Forks (855)	2153 WKSJ 94.9 AL Mobile (970)
1915 KOAQ 103.5 CO Denver (1270)	2155 WELX 92.9 AL Mobile
1916 KLTR 100.3 CO Denver	2201 WWOV 89.9 LA New Orleans (1070)
1925 KLOV 102.3 CO Loveland (1265)	2203 WEZB 97.1 LA New Orleans
1929 KPFM 89.3 ND Grand Forks (855)	2211 WRGI 93.5 FL Naples (1180)
1937 KMAV 101.7 ND Mayville (860)	<u>7/29 Es</u>
1940 KRAD 103.9 MN E. Grand Forks (850)	1804 KZZQ 94.3 LA Golden Meadow (1100)
1952 KQDY 94.5 ND Bismarck (1010)	<u>7/30 Es</u>
(1st time by new CL - prev. KEMR via MS)	0058 KEVA 88.3 ND Belcourt (990)
2001 KOSN 99.3 MN Thief River Falls (820)	0109 KCGM 95.7 MT Scobey (1240)
2007 CHMN 97.5 MB Winnipeg (910) (1st time by new CL & Es - prev. by MS(CJOB))	0114 KOSN 99.3 MN Thief River Falls (820)
2011 CHIQ 94.3 MB Winnipeg (910)	0201 CFMQ 92.1 SA Regina (1235)
2101 KSHE 94.7 MO Crestwood (605)	<u>7/30 Es</u>
2116 KNGN 92.5 OK Oklahoma City (1045)	1733 WGVL 93.5 FL Vero Beach (1080)
<u>7/27 Es</u>	1758 WATA 97.3 FL Miami (1205)
1724 ZEM 89.1 Bermuda (1140)	1759 WMCU 89.7 FL Miami
1902 WVFM 94.1 FL Lakeland (1065)	1802 WCKO 102.7 FL Pompano Beach (1190)
1905 WQIX 99.1 FL Jacksonville (910)	1805 WYOS 100.3 FL Plantation Key (1280)
2002 WMCU 89.7 FL Miami (1205)	1813 WDNJ 94.5 FL Daytona Beach (1050)
2133 WPTW 99.3 FL Ft. Walton Beach (960)	1833 WRGI 93.5 FL Naples (1180)
	1840 WLCY 94.9 FL Tampa (1070)
	1846 WWSA 107.3 FL St. Pete. (prev. by MS)

Michael L. Hogan - 9224 Cottage Grove Ave. - Highland, IN 46322

Eq: Panasonic RF-877, Stereoprobe-9 ant. @17', hand-rotated. New underlined. All stations recorded on cassette tape.

<u>7/7 Tr</u>	<u>7/17 to 8/1(23 new loggings in this period)</u>
0645 WSSR 91.9 IL Springfield, ad, wx	<u>7/18 Tr</u>
0700 WJRE 92.1 IL Kewanee, ID	0708 KSLQ 98.1 MO St. Louis, ID, wx (300)
<u>7/8 Tr</u>	<u>7/31 Es</u>
0645 WFTN 94.1 WI Watertown, ad, weather	???? WCOZ 94.5 MA Boston, ID ad
0700 WCLL 94.3 OH Chillicothe, ad, weather	<u>8/3 Es</u>
0705 WNNI 99.7 OH Columbus, sports	1739 WVVA 94.1 VA Yorktown, k, ID
0715 WMDH 102.7 IN New Castle-Muncie, ID, k	1744 WPOG 92.9 VA Suffolk-Norfolk, \$-93
0730 WPOK 103.1 IL Pontiac, ad	1750 WRBS 95.1 MD Baltimore, relig. prog, ID
<u>7/11 Tr</u>	1801 WICO 94.3 MD Salisbury, NX in brief
0700 WAWK 93.3 IN Kendallville, ad	1803 WKLP 94.1 WV Keyser, Tri-state wx
<u>7/12 Es</u>	Numerous Es openings have been noted especially to the NE and E parts of the U.S. On occasion MUF's to 99.9. Totals: 207, 88-92, 37, Es: 15, 10w stns: 5, CN:1, U.S.:16, TPU:17.
1859 WRSU 88.7 NJ New Brunswick, wx, ID	
<u>7/13 Tr</u>	
0504 WVLJ 105.5 IL Monticello, ID	
0528 WTAZ 102.3 IL Morton, ID, wx	
0530 WCCO 102.9 MN Minneapolis, ID, wx (420 mi)	

John Ebeling - 9209 Vincent Ave. S. - Bloomington, MN 55431 Phone: 612-888-0816

<u>7/3 Es</u>	<u>7/4 Es</u>
1830 WSR5 96.1 MA Worcester, ads, ID	1502 WCOL 92.3 OH Columbus, (short skip)
1840 WHIM 94.1 RI Providence, k, SCA mx on	1503 WLRG 92.3 VA Roanoke, "large" mx on SCA
<u>7/4 Es</u>	1515 WKYS 93.9 DC Washington, rock
1107 WYYZ 92.5 CT Waterbury, m, Tone on SCA	1516 WFLS 93.3 VA Fredericksburg, mx on SCA
1110 WLWH 93.7 CT Hartford, spanish program	1532 WKLP 94.1 WV Keyser, rock
1119 WRFM 93.3 MA Taunton, r, Stereo-93	1535 WRVQ 94.5 VA Richmond, rock, "Q-94"
1130 WYLS 98.3 CT Willimantic, mx for 2 of us	1539 WRFL 92.5 VA Winchester, k, mx on SCA
1131 WLKW 101.5 RI Providence, m	1542 WKVI 101.7 VA Kilmarnock
1137 WBCN 104.1 MA Boston, station promo	1545 WYHR 101.3 VA Hampton, ABC NX
1145 WHIN 94.1 RI Providence	1555 WAJR 101.9 WV Morgantown, r, "102-mobile"
1155 WFLY 92.3 NY Troy	1600 WGH 97.3 VA Newport News, mx on SCA
1202 WHVW 97.7 NY Hyde Park	1601 WEZS 103.7 VA Richmond, m, mx on SCA
1302 WMGX 93.1 ME Portland, rock	1604 WRFL 92.5 VA Winchester, NX, mx on SCA
1305 WJFD 97.3 MA New Bedford	1605 WYFI 99.7 VA Norfolk, gospel
1315 WPNH 100.1 NH Plymouth	<u>7/23 Es</u>
1455 WQDR 94.7 NC Raleigh, rock	1427 WKLH 92.3 AL Montgomery, rock



John Ebeling report - continued.

7/23 Es	7/26 Es
1430 WRAS 88.4 GA Atlanta, NX	1058 KBDM 94.9 NM Roswell, m
7/11 Es	1114 KRWN 92.9 NM Farmington
1830 WFLS 93.3 VA Fredericksburg, k, mx SCA	1120 KPJK 93.9 CO Colorado Spgs, r, "K-94"
1830 WBCI 96.1 VA Williamsburg	1130 KUCB 94.1 CO Montrose, m, \$
1831 WMBL 95.9 NC Morehead City	1802 KUPM 89.1 MT Missoula, sta. promo
1843 WCOL 98.3 VA Lynchburg, FM conv. ad	1805 KIVE 96.1 MT Glendive, m, UPI NX, ver. pol.
1845 WTVR 98.1 VA Richmond	1814 KANR 98.1 MT Great Falls, m
1846 WQSM 98.1 NC Fayetteville, rock	1815 KYSS 94.9 MT Missoula, m
1848 WSVS 104.7 VA Crewe, country	1826 WNNI 100.9 VA Warsaw, k, mono
1850 WNCT 107.7 NC Greenville	1837 WBAI 101.7 VA Kilmarnock, ID, rock
1900 WKRI 105.3 VA Norfolk, gospel	1845 WYVA 94.1 VA Yorktown, country
1904 WCMS 100.5 VA Suffolk	1900 WYCS 91.5 VA Yorktown, rock
1916 WEZS 103.7 VA Richmond, m	1900 WMRA 90.7 VA Harrisonburg, classical
1928 WAVA 105.1 VA Arlington	1902 WGAN 89.1 VA Williamsburg
1930 WQRK 104.5 VA Norfolk, rock	1906 WCMS 100.5 VA Norfolk, country
1934 WEXM 107.5 VA Ekmore	7/27 Es
1938 WKRA 105.9 VA Woodbridge, country	1100 KNFM 92.3 TX Midland, m
2000 WGTB 91.9 MD Takoma Park, m, then c	7/28 Au
2005 WYCS 91.5 VA Yorktown, UPI NX	2230 WGPR 107.5 MI Detroit, rock
2005 WVUT 90.5 VA Blacksburg	2300 WDLB 106.5 WI Marshfield, m
2028 WVSC 97.7 PA Somerset	2305 WRCS 93.1 SD Sturgis
2030 WFOG 92.9 VA Suffolk-Norfolk	7/29 Es
2035 WKRA 105.9 VA Woodbridge, again	1629 WFSU 91.5 FL Tallahassee
2042 WPGC 95.5 MD Morningside, rock (which way are they directional?)	1630 WUSF 89.7 FL Tampa, talk on SCA
2058 WZR 106.7 VA Manassas, m	1643 WWBA 107.3 FL St. Petersburg, m
2100 WTYL 97.7 MS Tylertown	1645 WJTW 100.7 FL Tampa/St. Pete., m, mx on SCA
2100 WWNO 89.9 LA New Orleans	1647 WDUV 103.3 FL Bradenton-Sarasota
7/16 Tr	1659 WQXM 97.9 FL St. Petersburg, "98-Rock"
1830 KVSC 88.5 MN St. Cloud, 10w, rock	7/31 Es
(Been trying for KVSC for about 4 yrs, then I get them 2 nights in a row via excellent trop)	1745 WJCL 96.5 GA Savannah, m, music on SCA
7/25 Es	1759 WTOC 94.1 GA Savannah
2130 WFCR 88.5 MA Amherst, station promo	1800 WJCT 89.9 FL Jacksonville
2145 WTIC 96.5 CT Hartford, rock	1813 WKTY 96.1 FL Jacksonville, m
	1814 KYR 93.3 TX Port Arthur, k, mx on SCA
	1815 WJLM 97.3 GA Savannah
	1848 WRAS 88.5 GA Atlanta, jazz

Stations received on 7/3, 7/4 & 7/23 were logged at my cabin in Prosit, MN, 30 miles NW of Duluth, MN. Eqt: Sherwood S2200 tuner (tube) and 5-element attic mounted FM antenna. All stations received on others dates were logged at my main location in Bloomington, MN. Eqt: Heath AJ-15, & 10 element CM yagi. New underlined. Times in CST. Note: About the middle of the month I acquired a Sony ST-5130 tuner and have begun using both the Sony and Heath for DXing at the Bloomington location. 73 -- John.

Fred McCormack - Des Lacs, ND 58733 (CDT)

7/9 Tr	7/16 Tr
0923 KPOX 92.5 MT Havre, UPI (375)	0850 WJAG 106.7 NE Norfolk (475)
7/9 Es (MUF to 107.7 at 2053)	0856 KVNO 90.7 NE Omaha, jazz (555)
2037 WTVY 95.5 AL Dothan (1450)	0915 KJSK 101.1 NE Columbus (515)
7/16 Au	0917 KFOR 102.7 NE Lincoln, Am FM News (565)
0354 KGGO 94.9 IA Des Moines (600)	0925 KOOD 104.5 NE Omaha (555)
0358 ELIN 107.3 NE Lincoln (565)	0929 KFMQ 101.9 NE Lincoln, rock (565)
0422 WLIB 103.7 WI Ladysmith, relig. (525)	0936 KRWY 98.9 NE Kearney (535)
0430 KNWS 101.9 IA Waterloo, relig. (600)	7/17 Tr
0500 KPAT 97.3 SD Sioux Falls, s/on (405)	0437 KSTP 94.5 MN St. Paul (460)
0501 WDLB 106.5 WI Marshfield, (595)	0822 WAKX 98.9 MN Duluth, "\$-99 Wax" (450)
0504 KTCR 97.1 MN Minneapolis (455)	0830 WRVM 102.7 WI Suring, gospel (650)
New stations underlined, dash=new mode,	7/18 Tr
Eqt: Des Lacs - Heath AR-1500, JFD log ant.	2234 KCJB 97.1 ND Minot, "rock-99" (230)
Fargo - Heath AR-15, rabbit ears. 73-Fred.	(received in Fargo)

Patrick Martin - P.O. Box 14192 - Portland, OR 97214 (PST)

Eqt: Receiver - Pioneer TX-9100, Antenna - 10 element Lafayette (FM), Winegard trap.

1/1 Tr	5/20 Tr
1600 KUEZ 104.1 WA Yakima, CL change (150)	1806 KORD 102.7 WA Pasco, rock (250)
1/2 Tr	1807 KONA 105.3 WA Kenniwick, KBIQ QRM (250)
0015 KTOY 91.7 WA Takoma. (125)	1832 KMBI 107.9 WA Spokane, g sta. u/KHPE (300)
2/14 Tr	6/8 Es
1610 CEC 106.7 BC Trail, CEC-very poor cl	1932 KVMF 104.7 CO Vail, c, L&C (900)

Patrick Martin report - continued.

6/10 Es	6/28 Es
1717 KSDM 107.1 AZ Apache Junction (1000)	2007 KLIN 107.3 NE Lincoln, LAC (1200)
6/22 Tr	2010 KTFK 106.9 KS Topeka, country, weak(1200)
2218 KZAM 92.5 WA Seattle, good sig. (150)	2017 WJAG 106.7 NE Norfolk (1175)
2226 KISM 92.9 WA Bellingham, album r. (225)	2048 KIOV 104.7 SD Sioux Falls (1100)
2224 KELE 93.3 WA Seattle, religious (150)	2051 KVSJ 89.7 SD Vermillion (1150) c
2231 KEUT 94.1 WA Seattle	2057 KCFP? 90.1 SD Sioux Falls, SD news items
2243 KIT 94.5 WA Yakima (150)	2059 KVOB 94.3 IA Sioux Center (1200)
2246 KUOW 94.9 WA Seattle	2100 KEPM 96.1 NE Omaha, LAC (1200)
2248 KIXI 95.7 WA Seattle	2101 KSEZ 97.9 IA Sioux City (1200) strong
2251 KZEL 96.1 OR Eugene (110)	2105 KGOR 99.9 NE Omaha (1200) LAC
2300 KYX 96.5 WA Seattle	2109 KGBI 100.7 NE Omaha, local quality (LAC)
2306 KNBQ 97.3 WA Tacoma (125)	2115 KFOR 102.7 NE Omaha, very strong
2323 CBUP 97.7 EC Vancouver (250) FFC	2118 KTFK 103.3 IA Sioux City, religious (1200)
2327 KINF 98.1 WA Seattle, classical music	2121 KLFM? 104.1 IA Ames, rock (1300)
2330 KEZI 98.9 WA Seattle	2123 KHAT 106.3 NE Lincoln (1200)
2340 CKLG 99.3 EC Vancouver	2127 KOWH 94.1 NE Omaha, soul
2345 KLSW 99.9 WA Seattle	2131 KTAP? 103.9 NE Crete, baseball (1150)
6/23 Tr	2135 KRGI 96.5 NE Grand Island (1170)
0711 KSEA 100.7 WA Seattle	2138 KCKC? 88.3 IA Cedar Rapids (1300)
0716 KVI 101.5 WA Seattle, rock	2140 KQHU? 104.1 SD Yankton (1150)
0717 KFLY 101.5 OR Corvallis (65) u/KVI	2208 KELO 92.5 SD Sioux Falls (1150)
0730 KPQ 102.1 WA Wenatchee (200)	2210 KFTJ 92.9 ND Bismarck (1100)
0732 KZOK 102.5 WA Seattle	2213 KSJM 93.3 ND Jamestown (1100)
1924 KICE 100.7 OR Bend (120)	2215 KQDY 94.5 ND Bismarck (1100)
1929 KIXI 94.1 OR Bend	7/1 Es
6/24 Tr	1930 KLLL 96.3 TX Lubbock, religious (1300)
2010 C??? 103.1 EC Vancouver, u/translator	1931 KISM 99.9 TX El Paso, rock (1150)
2252 PQDQ 97.7 OR Vancouer (60) weak/fadey	1934 KINT 97.5 TX El Paso, rock (1150)
That should do it for this time. As you can	1937 KTEP? 88.5 TX El Paso, classical
probably tell, I got the TX9100 on 6/22.	7/4 Es
Most of the Tr stuff is new as I could never	1932 KPXA 96.1 CO Greeley, Easy Listening (900)
with the Magnavox. Good DX --- Patrick.	receive anything much between the 100kw locals

Fred Nordquist - 7945 Bonford Road - Clay, NY 13041 (EDT)

Eq: Receiver - Heathkit AJ-15, Antenna - JFD LPL FMO1A @ 45° AGL, Rotor, new underlined.

7/12 Es 2130 tune-in to 2315, MUF:108+	7/31 Es
2147 KJCS 103.3 TX Nacogdoches, k, SID	1826 KPDI 101.3 KS Wichita, country
2152 KSKU 102.1 KS Hutchinson, lcl ads	1857 <u>KNID</u> 96.9 OK Enid, BB o/semilcl WOUR
2200 KROA 95.7 NE Grand Island, ID	1858 <u>KSWJ</u> 93.5 OK Woodward, m (1300)
2200 KETR 88.9 TX Commerce, ID/Time check	1916 <u>KXXX</u> 105.5 OK Chickasha, gospel music
2300 WPCS 89.3 FL Pensacola, gospel, ID	1926 <u>KATT</u> 100.5 OK Oklahoma City, "the cat", r
2305 WKSJ 94.9 AL Mobile, ID	2039 Unid 98.3 Spanish music -- who? PTA:SW
2310 WQID 93.7 MS Biloxi, soul, ID	8/2 Es 1850 to 2115 MUF: 93.9
7/14 Tr to Qtho (Very narrow path)	1859 KSIW 93.5 OK Woodward, ID
2153 WCOL 92.3 OH Columbus, rock (420)	8/3 Es 1815 to 1945, MUF: 108+++
2155 WQFM 96.3 OH Columbus, "QFM-96"	1826 KSKU 102.1 KS Hutchinson, ads
2200 WENS 97.1 OH Columbus, ID	1850 KKKZ 107.5 LA Rustin, rock \$
7/22 Es 1821 tune-in to 2005, MUF: 103.9	1852 KLWN 105.9 KS Lawrence, "106 ex station"
1821 KETR 88.9 TX Commerce, lcl NX	1902 <u>KBTM</u> 101.9 AR Jonesboro, rock, time ok
1826 WCCF 92.7 FL Punta Gorda, m	1906 <u>WFMJ</u> 106.5 IN Washington (650) ID
Many Tampa/St. Pets/vicinity stations	1908 <u>KLOQ</u> 106.1 KS Lyons, lcl annts, ID
2005 WNCU 89.7 FL Miami, lcl	1925 <u>KNIM</u> 95.3 MO Maryville, country
7/23 Es briefly at 1612 PTA: MN	8/12 Ms (Perseids)
7/30 Tr	0140 <u>KZCV</u> 90.5 MO Maryville, lcl annt (970)
0014 WMOV 93.7 OH Mt. Vernon, ID	(prev. logged via Es)
7/30 Es 0039 to 0105, & 1725 to 1824	0252 <u>WZUU</u> 95.7 WI Milwaukee, ID (585)
0039 <u>KCGM</u> 95.7 MT Scobey, lcl BB (State#391)	(prev. logged via Propo)
0105 KPFM 89.3 ND Grand Forks, ID	Many bursts noted with many near-IDs, on 8/12.
1725 Unids PTA: KS MO OK	Corrections: 6/8 Es KIXX 96.1 SD Watertown -
7/31 Es 1730 tune-in to 1852, MUF: 108+	replay of tape revealed "Kicks96"
1742 <u>KRFG</u> 93.5 MO Greenville, k, ID	SID, then into auto rock. (not KWAT)
1750 <u>WESE</u> 92.7 IL Taylorville, "W-3E" (715)	4/8 Gw CJBC-17 95.5 ON Belleville
1755 <u>KJMO</u> 100.1 MO Jefferson City, k, "J-100"	(not 107.5) FFC.
1806 <u>KRMS</u> 93.5 MO Osage Beach, rock	Wow! This completes 10 pages of DX filled
1811 <u>KARC</u> 92.9 OK Tulsa, lcl ads	FM reports. It sure has been a fantastic
1817 <u>KKNG</u> 92.5 OK Oklahoma City, lcl ad, ID	year for Es. 73 - Fred.





# Southern F.M.D.N.

Dave Cox  
2704-C Briarberry Cir.  
Birmingham, AL 35226

SEPTEMBER 1977

Deadlines: the 10th

SERVING FM DXers OF THE SOUTHEAST, SOUTHWEST, AND MEXICO

DAVID NELSON 1507 Lamont Court, Chapel Hill NC 27514 EDT

7-24-77  
Es 0008 WLRG 92.3 VA Roanoke coming in like  
a ton of bricks w/new AAF of 2002'

7-27-77  
Es 2155 KGHU? 90.9 TX Dallas w/documentary  
2202 KROZ 92.1 TX Tyler jk  
2213 KAZI? 88.7 TX Austin ;j WSHA QRM  
2216 KSUC? 88.3 TX Keene w/ sign off  
after tornado warning  
2227 KHDO 99.9 TX Waco ;jk

7-31-77  
Es 1839 KSJR 90.1 MN Collegeville state nx  
1901 KSJN 91.1 MN St. Paul w/state nx  
1920 KQKQ 98.5 IA Council Bluffs ;p

8-1-77  
Es 0903 WWV 97.5 VA Charlottesville ;p  
new call, ID as "3-W-V"

8-2-77  
Es 0932 WRBK 101.9 NC New Bern ;r\$ "K-101"

8-3-77  
Es 0149 WOOT? 91.9 TN Knoxville ;c very weak  
0155 WRBO? 93.3 NC Forest City NC nx net  
Es 1849 KMYR 93.7 SD Winner ;r WFBC QRM  
Just joined the club so I thought I'd give a brief intro: I'm 14 and will be going into the 9th grade. I'm also a member of IRCA. I've been FM-TV DXing for about a year. Had some really great ES openings in the middle of June when I was at the beach (Sunset Beach, NC) into Texas. The 8-3 opening was really nice, although the MUF was only 94.5. The educational band was loaded, but all the stations were carrying 'All Things Considered' or some other program with few IDs, so I didn't log very many of them. (A very good report, David. Thanks for reporting and keep up the good work. ...dsc)

Ron Wing 705 N Emporia, Apt. 2, Wichita KS 67214 GDT

5-20-77  
Es 1727 WQYK 99.5 FL St. Petersburg  
1734 WQSR 102.5 FL Sarasota  
1741 WKEM 102.7 FL Pensacola

5-30-77  
Es 1505 WFIS 93.3 VA Fredericksburg rec-  
sived on ES hiway 96 approx. one  
mile west of Nekoma KS

6-1-77  
Es 0745 KZUE 102.7 OK Oklahoma City first  
time heard w/ new call letters  
0755 KLUK 99.9 TX Wichita Falls  
0800 KNUS 98.7 TX Dallas

6-2-77  
Es 0744 KHID 96.9 OK Enid

6-6-77  
Es 2011 WJML 98.9 MI Petosky  
2028 WQWQ 104.5 MI Muskegon  
2045 WSMH 99.5 MI Sault Ste. Marie  
Preceding loggings made on Craig 3146 car  
radio. Following ones on a Pioneer SX-450  
with indoor dipole.

6-9-77  
Es 1720 KJOK 93.1 AZ Yuma  
1746 KILA 95.5 NV Henderson  
1749 KIXY 96.5 CA San Diego  
1751 KORK 97.1 Las Vegas  
1759 KFMB 100.7 CA San Diego  
1811 KBBC 98.7 AZ Phoenix  
1815 KBEL 99.1 CA Riverside  
1901 KNUW 94.5 MT Great Falls

6-13-77  
Es 2300 KIOL 99.3 ES Iola KOYY off  
(Many thanks for the report, Ron! ...dsc)

8-3-77  
Es 1742 WAYL 93.7 MN Minneapolis ;m  
1752 KQDE 92.1 MN Waseca ;jk UPI nx  
1808 KDDM 94.3 MN Window with ad  
1824 KVDB? 94.3 IA Sioux Center w/jingle  
1828 KBEM 88.3 MN Minneapolis w/wx  
1837 WUMM? 89.7 WI Milwaukee with announc  
of events at "UWM"  
1857 WBSA 89.9 WI Brule state nx and ID  
WHLA? 90.3 WI LaCrosse tentative  
no ID but //WBSA  
WMMG? 88.3 WI Mononaie tentative  
no ID but //WBSA  
1912 CKY 92.1 ME Winnipeg ;m  
1914 WSCD 92.9 MN Duluth w/wx & ID  
1924 KSTP 94.5 MN St. Paul "KS-95"  
1926 WIAL? 94.1 WI Eau Claire ;m with  
QRM from WLEW

1931 KBMO 93.5 MN Benson talk  
1938 KKDQ 92.9 ND Grand Forks ;r "KDQ"  
2002 KEYA? 88.5 ND Belcourt ;r with YL  
announcer; QRM from WFDD

6-14-77  
Es 0716 KIPK 106.9 KS Topeka  
Es 1807 WFPI 92.5 PA Philadelphia  
1823 WJNL 96.5 PA Johnstown  
1845 WLEV 96.1 PA Easton  
1855 WWDG 96.5 PA Philadelphia  
1916 WMMR 93.3 PA Philadelphia  
1924 WDAC 94.5 PA Lancaster  
1926 WFLN 95.7 PA Philadelphia  
1930 WLAN 96.9 PA Lancaster  
1935 WUFM 100.1 PA Lebanon  
1941 WQXA 105.7 PA York ID as 'Q-106'

6-16-77  
Es 2130 KDVV 100.3 KS Topeka ID as 'K-dove'  
2145 KFOR 102.7 NE Lincoln  
2213 KPNB 101.9 OK Oklahoma City

6-20-77  
Es 2037 WQDR 94.7 NC Raleigh  
2039 WMYA 96.3 VA Martinsville  
2044 WQMD 97.1 NC Martinsville  
2047 WGLD 100.3 NC High Point

6-25-77  
Es 1516 WINZ 94.9 FL Miami Beach local  
KIGT off air w/wxtr problems  
2219 KONA 105.3 WA Kennewick  
2220 KDHM 98.3 MT Dillon  
2255 ? 93.3 MT Missoula called it-  
self 'SD-93' Does anyone have any  
idea of the call letters?

6-26-77  
Es 0900 KROA 95.7 NE Grand Island  
Es 1730-1830 unIDed Spanish stations on 93.3,  
96.9, 97.3, 99.3, 100.5, 106.9

Clint McAuliffe 1103 7th St. Apt. 6E, Greeley CO 80631

MDT

Well, it is the end of June and time to send in another DX report. I had only two really good days this month, the 9th and 22nd. Sure am glad that I had my SCA adapter; it helped me figure out many stations. I have tried a number of different SCA adapters using the Signetics 565 phase-lock loop. They all work, but not nearly as well as the circuit found in the 1977 Popular Electronics Experimenter's Handbook. The integrated circuit in this adapter contains a complete FM strip on a single chip. Connections are the same as for the PLL adapters. I run the output from the adapter through my second tape monitor switch on my Pioneer SX-636 receiver. That way I can check a station instantly for SCA. The tape monitor switch completely chuts off the main channel program. The audio output of this adapter is greater than the PLLs. That is, there is no need to increase the volume when the adapter is switched on. There is very little or no cross talk with this circuit when compared to the PLLs that I have tried. Although I do not use the squelch control when DXing, it is very effective; it works far better than the squelch control on Southwest Technical's PLL SCA adapter. Southwest Technical Products Corporation no longer sells the kit, but they will send you a completely assembled SCA adapter for \$29.95. That is a rip-off. \$13.50 to Communications Poly Services, 46 Groton Rd., Westford MA 01886 brings you a far better SCA adapter in a fun to build kit. Use an IC socket when assembling; one should be included with the kit but is not. Enjoy. On to the DX report.

Equipment: Pioneer SX-636 receiver with Jerrold 14 element Yagi @ 30 ft.

Underlined are relogs. SCA indicated with a + mark.

6-6-77

Es 0925 WVWR 89.1 VA Roanoke (1360);c,\$ ID  
0935 WIAA 88.3 MI Interlochen (1010);c,\$  
0945 WCMU 89.5 MI Mt. Pleasant(1060);c,\$

6-9-77

Es 0830 WAMU 88.5 DC Washington(1460);P\$ ID  
0850 WOSU 89.7 OH Columbus(1150);\$ ID  
0900 WVPB 91.7 WV Beckley (1275) ID  
0905 WMOA 94.3 OH Marietta (1230) ID  
0915 WVPW 88.9 WV Buckhannon (1300) ID  
0945 WQOQ 88.5 TN Memphis (880);r \$  
0946 WRAY 98.1 IN Princeton (925) \$  
0948 WHKW 98.1 AL Fayette (1050);r\$ with  
ID as "FM-98"  
0950 WHIC 94.3 KY Hardinsburg (990);k\$  
0955 WAMZ 97.5 KY Louisville (1020);m\$ +  
SCA muzak

1000 WMIX 94.1 IL Mt. Vernon (855);m\$ +  
with music SCA  
1001 KWPM 93.9 MO West Plains (740) \$ +  
w/ mx, ID, music SCA  
1015 WKSU 89.7 OH Kent (1210) \$ + talk  
about plays

1020 WKNT 100.1 OH Kent (1210);r  
1022 WVJC 89.1 IL Mt. Carmel (910);r\$  
w/ID. Still 10w?  
1025 WHIN 104.5 TN Gallatin (1020);r\$ ID  
1032 WDEB 103.9 TN Jamestown (1120) \$ ID  
1033 WSBT 105.5 TN Sparta (1090) ID  
KSIG 97.3 MO Sikeston (850);k ID  
1034 WGGC 95.1 KY Glasgow (1040);g ID  
1036 WNDJ 95.1 AL Huntsville (1070);g\$  
1040 WJJM 94.3 TN Lewisburg (1030);g  
1041 WBGY 93.3 TN Tullahoma (1090)\$

"Boogie radio for the  
Mid-South"  
1045 WMBW 88.9 TN Chattanooga (1120);g  
WDYN 89.7 TN Chattanooga (1120);g  
1046 WDOD 96.5 TN Chattanooga (1120);k\$  
1047 WLRH 89.3 AL Huntsville (1070);c\$  
no SCA heard

1050 WQXI 94.1 GA Smyrna (1205) \$ "94-Q" 6-30-77

6-17-77

Es 1045 WSAI 94.1 OH Cincinnati (1080);pr\$+  
Physician's radio SCA  
1047 WMUB 88.5 OH Oxford (1065) w/ID, nx

That is about it for this time. The stations that did not give an ID have been figured out by mention of location, SCA, time, or dead reckoning. While receiving the Canadian stations, I tuned up over 108 MHz and heard several VOR stations, but no IDs.

Good DX to everyone, Clint.

6-22-77

Es 0920 CHEF 98.1 ON Toronto (1315);m\$ +music  
0921 CBL 94.1 ON Toronto (1315);c\$  
0922 CKFM 99.9 ON Toronto (1315);m\$ ID  
0923 CHUN? 100.7 ON Toronto (1315) French  
0924 CHIN 104.5 ON Toronto (1315);pr\$ +music  
received the above for over one hour in-  
mitantly

0930 WVOR 100.5 NY Rochester (1400);rm \$ w/  
oldies & ID; +music  
0935 WDXU 92.7 WI Waupaca (840) \$ ID  
0935 WKCQ 98.1 MI Saginaw (1090);r\$ ID  
0938 CIGM 92.7 ON Sudbury (1260);mr \$ ID  
0942 CKLA 106.1 ON Guelph (1270) \$ ID  
0945 WWSB 107.7 MI Alpena (1120);kr  
0950 WBLK 93.7 NY DePew (1380);s\$ + Physi-  
ciana's Radio SCA

0955 CKQS 94.9 ON Oshawa (1350) \$ wx, ID +  
music SCA  
1000 WIAA 88.3 MI Interlochen (1010);c\$  
1010 CJOM 88.7 ON Windsor (1130);m \$  
1015 WRRK 97.7 MI Manatee (970);r\$ "FM-98"  
1020 WJML 98.9 MI Petosky (1050);r\$ ID  
1023 WUGN 99.7 MI Midland (1080);g\$ +bird  
chirp SCA (possibly a  
transmitter-studio link  
used for remote meter  
reading, etc.? ...dsc)

1025 WSMW 99.5 MI Sault St. Marie (1090);kr  
1030 WBEI 101.7 MI Tawas City (1110);m\$ ID  
1031 CHEX 101.5 ON Peterborough (1370);m\$  
1035 WCBY 105.1 MI Cheboygan (1080);m mono +  
talk(Paul Harvey) & music  
on SCA (an ABC net? ..dsc)

1040 CFGM 107.1 ON Toronto (1315);pr\$  
1045 WPON 107.1 WI Fond du Lac (870) \$  
1100 WKLA 106.3 MI Ludington (965);m\$ ID  
1110 WKZY 97.1 MI Escanaba (950) "Cozy Radio"  
1113 WLST 95.1 WI Marinette (910);r\$ +music  
1115 CBJN? 95.1 ON North Bay (1330) mono with  
French spoken

Es 1330 KELT 94.5 TX Harlingen (1070);k\$ +  
music SCA

1335 KBFM 104.1 TX Edinburg (1060);r\$

1336 KVVV 96.9 TX McAllen (1070);g mono

# KP500

PIONEER

Peter Sawatzky, VE3IXQ  
244 Neilson Ave.  
Waterloo, Ontario  
N2J 2M3

Having recently purchased a Pioneer KP-500 FM Supertuner, I have nothing but praise for this incredible piece of equipment which from my experience far outperforms any car FM receiver currently on the market as a piece of DX equipment. I found it, in fact, to be so impressive that there should be no real reason for not using it as a home receiver rather than just in the car. Naturally, a 12-volt supply would have to be added, but this apparent disadvantage might well become an advantage in the case of an opening coinciding with a power outage (which has happened here on at least one occasion) as battery backup could be employed.

To assess the value of the KP-500 as a DX receiver, I have made comparisons between it and the Heathkit AJ-15 in a home installation and between it and the Heathkit CR-1000 car FM tuner with CRA-1000-1 power amplifier in an automobile environment using only an ordinary automobile whip as antenna.

First, to the comparison with the AJ-15. Both the KP-500 and AJ-15 were connected to a common antenna (an Archer 5-element twin-drive) via a 300-ohm splitter. Connection was made to the AJ-15 via its 300-ohm terminals and to the KP-500 via a balun to its 75-ohm terminal. A Realistic STA-65C receiver was used as an amplifier for the AJ-15 and the audio outputs of the two units were switched into a common speaker (only one channel was used for comparisons) to enable direct A-B comparisons.

From the standpoint of sensitivity, no discernable difference could be found between the two units. The Heathkit AJ-15 claims better than 1.8  $\mu$ V IHF sensitivity while the Pioneer KP-500 specs state 1.1  $\mu$ V IHF. While it is conceivable that Pioneer is being somewhat optimistic in this rating, it should be noted that in previous tests of my AJ-15 when compared with a Marantz, it was found to be one of the hotter AJ-15's in terms of sensitivity. Therefore, how much better than 1.8  $\mu$ V the sensitivity actually is is in question. Also, the KP-500 was matched with a balun for this test and it will have some inherent losses. One can see therefore that if no discernable difference is found sensitivity-wise, the KP-500 is indeed impressive in this respect. Numerous stations in the 150-250 miles range were compared, many of which were right on the noise threshold. The KP-500 exhibited a very steep quieting curve, possibly even better than that of the AJ-15. This is supported by the specifications. The KP-500 claims 30 dB quieting at 1.1  $\mu$ V IHF and 50 dB already at only 1.4  $\mu$ V!! The AJ-15, on the other hand, has a somewhat more slowly rising curve specified with 1.8  $\mu$ V at 30dB and 50dB does not occur until about 2.8 $\mu$ V.

Alternate channel selectivity claimed by the KP-500 is 73dB at +400 KHz and 75 dB at -500 KHz, better than the claimed 70dB of the AJ-15. While this claim was neither proven nor disproven, it was found that the KP-500 did not exhibit superb adjacent channel selectivity which the AJ-15 is famous for. It was quite tolerable, however, and only a noticeable problem when compared with the AJ-15 on stations next to semi-locals (e.g. WLYT 92.3 Cleveland next to CKPC 92.1 Brantford - Cleveland at 145 mi. and 27 KW, Brantford at 25 mi. and 50 KW) when antenna bearing for the two was very much the same. The AFC had a greater tendency to pull towards the stronger station in the KP-500 than in the AJ-15 in these cases. Due to the proximity of CFCF 105.3 Kitchener (about 10 miles and 100 KW), there is considerable splatter experienced about this frequency. This was considerably more evident in the KP-500 than in the AJ-15 in trying to receive CHUM 104.5 Toronto at 55 miles and 40 KW. However CHSC 105.7 St. Catherines at 70 mi. and 50 KW could still be received without undue problems from CFCF and CKLA 106.1 Guelph at 15 mi. and 50 KW. CHSC is a classical test in this area for selectivity as it is situated between these two locals spaced 800 KHz apart.

Capture ratio appeared to be about the same on the AJ-15 and KP-500 (the AJ-15 claims 1.5 dB IHF and the KP-500 1.7 dB) when tested on 94.9 between CKQS Oshawa and WDBN Medina.

Switching from mono to stereo is not defeatable in the KP-500 and this feature can be somewhat annoying when a station's signal



strength varies frequently over a short period of time, as S/N ratio is considerably worse in stereo with weak signals than in mono, as is the case with any receiver. I hesitate to make any comparisons of stereo S/N ratio between the KP-500 and the AJ-15 as this is a function of too many variables - stereo threshold setting, amplifier response, tone control settings, signal strength, etc.

It can be readily seen from the preceding comparisons that the KP-500 performs incredibly well. The fact that a car radio can even be compared with a unit such as the AJ-15 is remarkable.

Next a comparison was made between the KP-500 and the Heathkit CR-1000 car FM tuner in conjunction with its CRA-1000-1 power amp. An ordinary car whip antenna was used and the location was abominable from a DX standpoint - in a garage, in a gully, between brick houses. Conditions were basically poor tropo-wise. First, the CR-1000 was scanned from one end of the band to the other to net the following stations: CKGN, Channel 6 (20 mi.); CJRT, 91.1 (55); CKPC, 92.1 (25); CHAY, 93.1 (75); CBL, 94.1 (55); CKDS, 95.3 (35); CFPL, 95.9 (55); CKGL, 96.7 (10); CHFI, 98.1 (55); CKWR, 98.7 (0); CKO, 99.1 (55); CKFM, 99.9 (55); CKOT, 101.3 (45); CKNX, 101.7 (50); CFNY, 102.1 (35); WBEW, 102.5 (90); CHUM, 104.5 (55); CFCA, 105.3 (10); CJOY, 106.1 (15); CILQ, 107.1 (55); and GING (35). Many of these stations were quite noisy, especially those at or beyond 50 miles. Toronto stations at 55 mi. were only fair. Going across the band on the CR-1000 netted effectively no new stations in addition to those already listed.

Then the KP-500 was scanned across the band. All of the stations which had been received on the CR-1000 were in, virtually all with near full quieting. In addition the following were heard: CJOM, 88.7 (155); WQLN, 91.3 (100); WBUF, 92.9 (90); WBLK, 93.7 (90); CKQS, 94.9 (90); WDCX, 99.5 (90); WNIC, 100.3 (155); CHIN, 100.7 (55); WRIF, 101.1 (155); WDET, 101.9 (155); WYFM, 102.9 (155); WPHD, 103.3 (90); WMUZ, 103.5 (155); WCCK, 103.7 (100); WZZP, 106.5 (145); WWWW, 106.7 (155). Going across the band again, one noticed that some of the preceding stations were gone, but new ones were in: WGPR, 107.5 (155); WBEA, 107.3 (170); WWOL, 104.1 (90); WCRF, 103.3 (145); CKTB, 97.7 (70); WAEZ, 97.5 (180). Going quickly across the band a third time an ID was even heard from WKWK, 97.3 (240). All this on a day with no tropo at all on a car FM radio in an abominable DX location.

The CR-1000 claims an IHF sensitivity of better than 3  $\mu$ V compared to 1.1 for the KP-500. These figures, if not proven, are certainly proven relative to one another by the above listing of stations. The CR-1000 basically has just as enough sensitivity to pull in the ground wave stations while the KP-500 pulls in those beyond 100 miles which flutter in and out due to minor atmospheric variations. It seems that every time one goes through the band on the KP-500 a new batch of stations is heard while on the CR-1000, it's always the same ground wave stations.

While no comparison could really be made on the selectivity of the two units (simply because not enough stations could be heard on the CR-1000), the CR-1000 claims only 60 dB alternate channel selectivity while the KP-500 claims 73/75 dB.

From an audio standpoint, the KP-500 also sounded considerably better than the CR-1000. The CR-1000 has only one tone control while the KP-500 has separate base, treble, and loudness controls giving considerable range of sound quality.

Other features of the KP-500 include:

- 1) Local/DX switch - gives 25 dB attenuation when travelling near transmitters
- 2) Power output of 8 watts RMS - more than enough for most people
- 3) Muting switch - provides interstation muting if desired
- 4) Cassette player - with fast forward, fast rewind, electromechanical eject button, auto-eject at end of tape, and tape pilot light
- 5) Automatic switchover from tape to radio after auto-eject
- 6) Stereo pilot light
- 7) Lighted dial and separately lighted dial pointer

Lafayette Radio Electronics' 1977 price on this unit is \$159.95. The Supertuner is also available with 8-track (TP-900) or 8-track plus AM (TP-7005). The TP-7005 is in-dash mounting while the others are under-dash.

The Pioneer KP-500 schematic and spec sheet follow. ?'s,

*John ?*

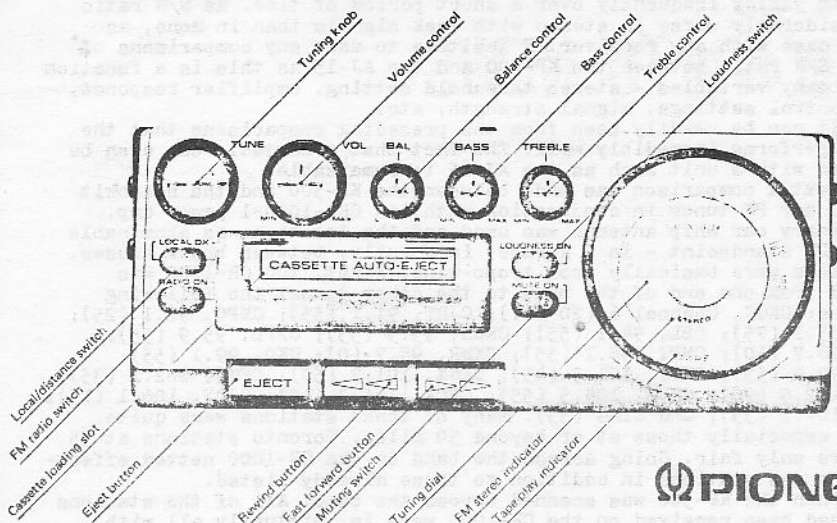

**PIONEER**

### KP-500 Specifications

<b>General</b>	
No. of ICs	8
No. of semiconductors	23
Grounding system	Negative type
Power output (rated)	8 watts (RMS)
Tone control effects	Bass $\pm 10$ dB (100Hz) Treble $\pm 10$ dB (10kHz)
Loudness contour switch effect	+9dB (100Hz), +4dB (10kHz)
Load impedance	4 ohms (2-8 ohms allowable)
Power source	DC 13.8V (11-16V allowable)
Dimensions (W x H x D)	192 x 75 x 190mm (7-5/8 x 3 x 7-1/2 in.)
Weight	2.3kg (5 lb.)
<b>Tape section</b>	
Tape	Compact cassette tape (C-30 ~ C-90)
Tape speed	4.75cm/sec. (1-7/8 ips)
Fast forward time	Within 100 sec. for C-60
Rewind time	Within 100 sec. for C-60
Wow & flutter	No more than 0.3% (WRMS)
Frequency response	40-10,000Hz

Crosstalk	More than 45dB
Signal-to-noise ratio	More than 50dB

<b>FM Supertuner</b>	
Frequency range	88-108MHz
Usable sensitivity	12dBf (1.1 $\mu$ V/75 ohms)
50dB quieting sensitivity	14.3dBf (1.4 $\mu$ V/75 ohms)
Signal-to-noise ratio	68dB
Capture ratio	1.7dB
Selectivity	73dB (+400kHz), 75dB (-400kHz)
Image rejection	61dB
Distortion	0.8%
Frequency response	30-12,000Hz (-3dB)
Muting level	5dB
Local/distance switch effect	25dB attenuation
Stereo separation	32dB

**Features of FM Supertuner**  
 Usable sensitivity of 1.1 $\mu$ V (IHF); automatic FM mono-stereo switching; automatic FM noise cut filter, FM muting

### SCHEMATIC CIRCUIT DIAGRAM

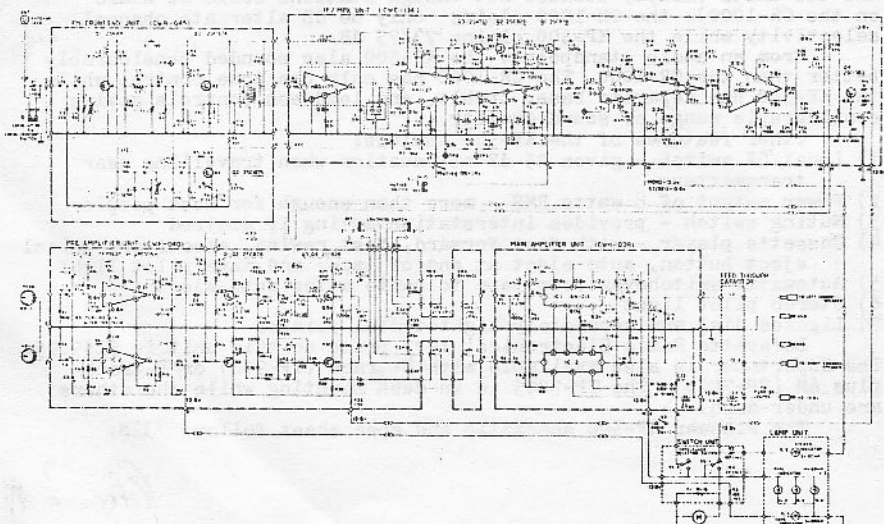

# PHOTO-NEWS



Jim Alexander  
4 Brook Court  
Parsippany, NJ 07054

September, 1977



WITN- 7 Washington, NC  
320 mile tropo (West)

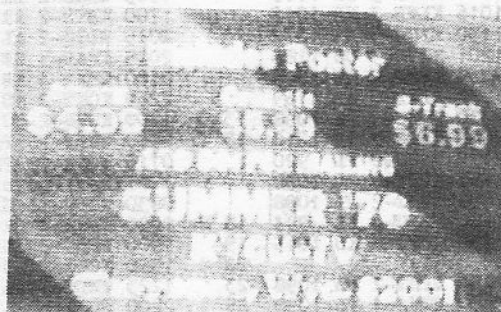

KYCU- 5 Cheyenne, WY  
1,325 mile E-skip  
7/1/76, 1700 EDT (Brindle)



KOSA- 7 Odessa, TX  
410 mile tropo (Everitt)



KDFW- 4 Dallas-Ft. Worth, TX  
965 mile E-skip (Combs)

Contributors:

Steve West,  
Havertown, PA

Ed Brindle,  
Latrobe, PA

Doug Everitt,  
Enid, OK

John Combs,  
Orlando, FL

73 and good DX,

*Jim*





Rick Glasgow, WDX5GB/G.E.M.S.-TV Box 16 Ackerman, Mississippi 39735 (GDT)

\*Very little DX noted here during May. One nice opening at the end of June. Not much time for DX, as I work at night lately. I'll have to catch more of those early a.m. tropo and midday Es openings. Equipment: Hitachi PD1 B/W portable & Hitachi PD5 color set, Channel Master VHF Quantum & Channel Master UHF parabolic."

May		19 Tr	2300	WOWL-15 AL	130	27 Tr	0120	XET-6 NL	
20 Es	1715	KOAA-5 CO		WHNT-19 AL				Monterrey	840
		Pueblo	920	WAAT-31 AL				(nice catch! -bt)	
	1730	KOA-4 CO		0015	KPLC-7 LA	310	0130	KXAS-5 TX	
		Denver	975	0036	KALB-5 LA	260		Pt Worth	460
		"probably ch 2 Den-		0047	WAFB-9 LA	250	0138	KZTV-10 TX	
		ver in also but		0050	KARK-4 AR	202		Corpus Christi	605
		local WMAB a big		0100	KGBT-4 TX	687	0210	KVTY-13 TX	
		problem"		0105	KTRK-13 TX	425		Laredo	705

June										
5 Es	0950	CKFR-2 ON						0215	KDFW-4 TX	430
		Thunder Bay	1250					0231	WSM-4 TN	230
		"Sunday morning						2348	unID-13	"saw
		WMAB off til 11:30								what I thought was
	1001	KDIX-2 ND	1150							KLTM Monroe(?)
	1003	unID-2 BTV								logo..."
		"KGFJ ND?"								(That's KLTM-13
										Monroe LA -bt)

"Log at 126. 73's and good DX."

Bob Walker 2220 W. Highway 524 Westport, Kentucky 40077 (EDT)

"After about three months in the club I thought I was overdue to report. Very poor equipment has enabled me to see quite a few goodies. All I use is rabbit ears and a UHF bow-tie antenna with a 12" Admiral portable. Here's what I've seen (all newies as I don't write down the repeats).

May										
18 Es	1720	KDIX-2 ND	1030	14 Es	1900	CKCK-2 SK	1235	8 Tr	2030	WPTO-14 OH
					2000	KQTV-2 MO	505	12 Es	2159	KRGV-5 TX
June				23	1957	KPRC-2 TX		13 Tr	2300	WHIO-7 OH
5 Tr	1029	WDCK-8 TN	175	July				19	0930	WCET-48 OH
14 Es	1700	KFYR-5 ND	945	2 Tr	0941	WCID-26 KY				

"WHIO seen the night of the blackout carrying 'Courtship of Eddie's Father' in favor of CBS net. Log total now stands at 65. Also DX BCB and a little FW; I'm a member of NRC. I'm willing to trade airchecks and always welcome correspondence. 73."

Edward R. Cotton 4106 2nd Street Chesapeake, Virginia 23324 (EDT)

"This is my first report to WTPDA. I use a RCA 19" portable and a Motorola 9" B/W TV with a Channel Master automatic rotor and antenna at 31'. For the past two weeks things have really opened up here. Reception has come in from Canada to South Dakota down to the Gulf coast and into the Caribbean."

June										
20 Es	1850	KXON-5 SD		24 Es	2000	CMLB?-5 CUBA		1 Es	1645	unID-5 CUBA
	2130	KHAS-5 NE		25	1250	unID-2 CUBA				"test patterns on
21 Tr	0635	WBCT-6 NC			1753	KMOI-4 TX				two Cubans"
Es	1900	KFSM-5 AR			1820	KXAS-5 TX		2	2030	WCBI-4 MS
	1930	KOGO-5 OK		26	1000	WAPA-4 PR			2200	KJAC-4 TX
	1955	KOTV-6 OK			1900	KTVY-4 OK		3	0830	KPRC-2 TX
	2100	KALB-5 LA		28	2000	KDFW-4 TX			0900	WBRZ-2 LA
22	0900	KTCA-2 MN		29	1900	CHSJ-4 NB			1000	WPBT-2 FL
23	1930	KTTT-5 TX			1930	unID 2,4 CANADA			1240	WBAB-2 MS
24	1930	unID-4 CUBA		July				Tr	2300	WBFP-45 MD
				1 Es	1645	unID-4 CUBA		4	0825	WCIV-4 SC

"They sure skipped around. I also take pictures of IDs, test patterns, etc. I use a Polaroid 220 and 107, 2000 speed B/W film. It does a pretty good job but I can only get about 5' from the TV. Good DX to all."

Martin J. Theil 12 Princeton Drive E. Holiday, Florida 33589 (EDT)

July										
1 Tr	0800	WJCT-7 FL		6 Es	0100	CBLT-5 ON		20 Es	1800	CBLT-5 ON
Es	0815	KTCA-2 MN			0600	WEBB-2 MA		21 Tr	1900	WJHG-7 FL
Tr	0835	WESB-2 FL			0610	CRCO-2 ON		22	1900	KPLC-7 LA
2	0930	WJHG-7 FL				WGR-2 NY		23 Es	1930	WTVH-5 NY
Es	0930	WKTV-2 NY		18	1800	WCBS-2 NY		24	1640	WAPA-4 PR
Tr	0930	WPTV-9 FL		19	1800	KCCT-2 KS		25 Es	2000	KRGV-5 TX
Es	0940	WTVH-5 NY			1830	WKTV-2 NY				KPRC-2 TX
					1900	WTWO-2 IN		31	1130	CBLT-5 ON

"I have just bought the Bear Cat 201 scanner and would like to hear from other members who have one as to their results. Also, in-line filters needed for scanners and TV. Help!!"

Roy D. Horsley Rt. 10 169 Lakeshore Dr. Gadsden, Alabama 35901 (205)442-2540

May (all times CDT)		June	
3 Tr 2100	WEAR-3 FL 250	30 Es 1330	CKPR-2 ON 1020
	WSLA-8 AL 150		1400 WJMN-3 MI 750
	"seldom received"		1440 KPRY-4 SD
2130	WKRQ-5 AL 250		1445 KKON-5 SD 1000
	WALA-10 AL 250		WCGO-4 MN 850
	WDIQ-2 AL 200	31 1130	unID 2,3 CANADA
7 Es 2000	WFSB-3 CT 950		KGHT-4 TX 900
	WCBS-2 NY 800		unID 3-5 Spanish
11 1815	unID 2-5 Spanish	1 Es 1700	KMID-2 TX 950
1820	XEW-2 DF 1200		1728 KACB-3 TX 860
	XEZ-3 Qro 1200		1945 XEFP-3 NL 1030
	XHD-4 Tams 1000		"it's been a long time..."
1830	XHY-3 Yuc 810	2 1130	WBZ-4 MA 1000
	XHGC-5 DF 1200		WCVE-5 MA 1000
1905	XHTV-4 DF 1200		WCVB-5 MA 1000
12 1630	KMID-2 TX 950	3 2230	XEZ-3 Qro 1030
	"unIDs 2 & 3	4 1920	KWGN-2 CO 1225
	til 1730"		MUF ch 4
2250	unIDs 3,4 Spanish	5 1000	WCBS-2 NY 800
16 1600	MUF ch 5, unIDs		WFSB-3 CT 950
	in Spanish		WBZ-4 MA 1000
1725	KOB-4 NM	1630	KOB-4 NM 1225
20 1635	KMID-2 TX 950		unIDs to ch 4
	KOB-4 NM 1225	1700	WLBZ-2 ME 1180
	KENW-3 NM 1040		WFSB-3 CT 950
1700	KFDX-3 TX 750		WBZ-4 MA 1000
	KNMR-5 NM 1175	1815	unID-5 Spanish
	KAMR-4 TX 920	1830	MUF ch 6
1705	KOB-4 NM 1175	1900	KUSD-2 SD 950
	MUF to ch 6	2000	KFYR-5 ND
"bad interference			Bismarck
to WERC-6"		8 1000	WCBS-2 NY 800
1705	KMID-2 TX 950	13 1830	XEFP-3 NL 1030
1730	KTXT-5 TX 920	14 1800	KTCA-2 MN 850
	KNMB-5 NM		KDAL-3 MN 950
Albuquerque	1175	1801	WCGO-4 MN 850
1750	KAMR-4 TX 920	15 0900	KQTV-2 MO 650
1820	KAVE-6 NM 1100	20 1300	KTCA-2 MN 850
1845	KACB-3 TX 860	1310	KDAL-3 MN 950
1910	KWAB-4 TX 800	2000	MUF ch 6
21 0900	KINH-3 NE 920	2030	KPRY-4 SD 1075
	KDUH-4 NE 1100	2040	WNEW-5 NY
0930	KTVS-3 CO 1060		New York 800
	KYCU-5 WY 1160		WCVE-5 MA "CCI"
	KPHO-2 WY 1300	2100	WCBS-2 NY 800
1030	KWGN-2 CO 1225		WFSB-3 CT 950
1145	KHAS-5 NE 940		unID-5 CBC
1800	unID-3 color bars	21 0930	CBOT-4 ON 1000
1830	XEZ-3 Qro 1200		0958 CKSO1-3 ON
29 1800	KMID-2 TX 950		Elliot Lake 950
30 1310	CKRN-4 QH 1075		1020 KBJR-6 MN T
	1315 unID 2-4 CANADA		1030 CHNB-4 ON 950

"Equipment: 1972 19" Admiral color set; 1962 9" GE B/W set; 9" Sears B/W set; Lafayette 3 element VHF antenna; 4-bay bowtie UHF antenna. As of June 26 I have installed Alliance rotor, Channel Master 20 element VHF antenna, 7' Channel Master Paraboloid UHF dish, Klonder-Tongue Voyager VHF-UHF pre-amp. System is working great. I am now receiving all 4 Atlanta UHF's daily. All night stations in this area include: WTCG-17, WOWL-15, WTIV-4. I've had more Es openings than I ever dreamed of. CGI 2-4 daily. I'm still having trouble with Spanish ID slides. WLCY was the first real long Tr I had ever seen. I had to pinpoint the antenna. Sometimes you just get lucky. Anyone wishing to swap TV GUIDES just mail me yours and you will get the Alabama edition in return."

Michael L. Hogan 9224 Cottage Grove Ave. Highland, Indiana 46322 (219)924-2361

"Equipment: DuMont portable B/W about 12 years old; Stereo Probe FM antenna & Winegard CH-9065 for JEP, both antennas at 12 feet & hand rotated."

July	August	5 Tr 0745	WICD-15 IL
------	--------	-----------	------------

31 Es 1900	KMOL-4 TX	3 Es 1700	WWAY-3 NC	"in solid for
	"seen at John Zondlo's"		"in w/local nx"	about 2 hours"

"Totals: 52 stations from 14 states and 2 Canadian provinces; 16 Es."



William J. Draeb Ellis St. R.R.#2 Kewaunee, Wisconsin 54216 (CDT)

"Lots of DK to report again and several new stations logged. A well placed tropo opening on the 14th and an exceptionally short (distance) Es opening on the 31st accounted for the new loggings. Today (July 31st) I saw Pittsburgh via Es (480 mi). The last time that happened was over twenty years ago (before I started keeping a log) when I saw KDKA-2. The tropo opening of the early morning hours of the 14th was quite welcome as it gave me the opportunity to log some of those Canadian stations that have been eluding me for so long."

July	Es	Time	Call	Power	Loc	Notes	Es	Time	Call	Power	Loc	Notes					
	5	1840	WCBS-2 NY	740			8	Es	2035	WDIQ-2 AL	925	12 Es 1913	WBCT-6 NC	882			
			WBBC-4 NY	740						WRAR-3 FL	986		WCSC-5 SC	916			
			WNEW-5 NY	740			9	1527	WDIQ-2 AL	925		1917	CFPR-3 AT	1320			
	Tr	2130	KOZK-21 MO	588					WRAR-3 FL	986		2101	KTVX-4 UT	1264			
			KMTC-27 MO	588					WTVY-4 AL	T		2102	KSL-5 UT	T			
			KGBJ-17 MO	450			1533	WWAY-3 NC	T			2104	KUTV-2 UT	T			
			KHLN-36 IA	457					WCBD-2 SC	916			KWBH-2 CO	T			
	2236		WATL-36 GA	T			1536	WJXT-4 FL	1039				KOA-4 CO	952			
			WHEP-25 IN	420					WSAV-3 GA	T		2122	WWAY-3 NC	882			
			WKYT-27 KY	473			2020	WMAB-2 MS	784			2131	KATC-3 IA	1026			
			WLKY-32 KY	437			2046	KMID-2 TX	1176			2145	KBNW-3 NM	1103			
			WDRB-41 KY	437					KACB-3 TX	1143		2205	KPDJ-3 TX	945			
	2308		WAAZ-31 AL	685					KAMR-4 TX	991			KAUZ-6 TX	T			
			2352	KINL-30 MO	432		2050	KDPW-4 TX	957			2227	KMOL-4 TX	1213			
	6 Es	1130	WEDU-3 FL	1192			2102	KBNW-3 NM	1103				KAMR-4 TX	T			
			WHSB-2 FL	1372			2110	KWAB-4 TX	1135			2230	KDPW-4 TX	957			
			WESH-2 FL	1130			2125	KPDJ-3 TX	945				KKAS-5 TX	972			
			WTVY-4 FL	1372			10	0852	unIDs 2,3 S.			2231	KCHS-6 TX	1075			
			1230	WRAR-3 FL	986		Tr	2020	WMUL-33 WV	498	13	1030	KOA-4 CO	952			
			1240	WTVY-4 AL	T				WVIZ-25 OH	355	Tr	1800	Youngstown U's				
				WJXT-4 FL	T				"snowfree over WBTT"				GICA-19 OH	410			
				WDIQ-2 AL	T				2020	CHLFT-25 OH	410		CHLFT-25 OH	410			
			1427	WMAB-2 MS	784				WUAB-43 OH	340			WJAN-17 OH	395			
			1430	KPRC-2 TX	T				CIGA-19 OH	410		1814	CITY-79 OH	410			
				KJAC-4 TX	T				Youngstown U's			1819	WVVU-24 WV	513			
			1500	WJXT-4 FL	1039		2025	Erie U's	405				WJRT-24 PA	405			
				WBBC-6 FL	1164		2037	KOZK-21 MO	588				1822	WPGH-53 PA	480		
			1530	WSAV-3 GA	933				KMTC-27 MO	588		2030	WUTV-29 NY	445			
			1830	WCBD-2 SC	916				KTVJ-16 MO	633			2004	WOSU-34 OH	395		
				WCLV-4 SC	916		2107	WUSI-16 IL	402			2043	WDRB-17 NY	445			
				WWAY-3 NC	882		2125	KSTN-27 IA	463				2051	WOLN-54 PA	405		
			1833	WCSC-5 SC	916				KFIN-21 IA	365				WVTV-53 VA	T		
	Tr	2135	KFIN-24 IA	300					KYIN-24 IA	300				WVIB-29 VA	T		
				KFIN-21 IA	365				2130	KGBJ-17 MO	450			2137	WOUC-44 OH	427	
				KSTN-27 IA	463				2133	KBMA-41 MO	525			2245	WHIZ-18 OH	400	
			7 Es	1055	KMID-2 TX	1176				KTSB-27 KS	T		2320	CHLFT-44 OH			
			1219	KAMR-4 TX	991					WAKR-23 OH	380			Peterborough	458		
				KBNW-3 NM	1103					WBAO-49 OH	380			2340	WBBY-36 NY	575	
				KDBC-4 TX	1355					WQEX-16 PA	480			2400	WKYT-27 KY	473	
			1500	WDIQ-2 AL	925					WPGH-53 PA	480	14		0004	WSEB-35 PA	405	
				WEDU-3 FL	1192					WNBO-45 OH	406			0014	WTAP-15 WV	476	
				WTVY-4 AL	934					2201	WJAN-17 OH	395		0019	WLKY-32 KY	437	
			1630	WGBH-2 MA	840					2206	WTAB-4 PA	T			CHLFT-32 OH		
				WGB-4 MA	840		11	0720	"R. OH & W. PA"						Kingston	543	
				WCVB-5 MA	840					2020	WUTV-29 NY	445			0028	CHLFT-15 OH	T
				WFSB-3 CT	T					2024	KTVJ-16 MO	633			0150	CHNY-10 OH	
			1645	WCBS-2 NY	740						KOZK-21 MO	588			North Bay	415	
				WBBC-4 NY	740						KMTC-27 MO	588			CHS-4 OH		
			1650	KYW-3 PA	T						2035	WUSI-16 IL	402		North Bay	415	
				WPVI-6 PA	T						2047	WKMU-21 KY	T		CHLA-5 OH		
			1657	WLBZ-2 ME	925		12 Es	1235	WCBD-2 SC	916			0205	Toronto	410		
				WABI-5 ME	925									CFPR-9 OH	410		
				WOSH-6 ME	855									CKNC-9 OH	350		
			1710	WCAV-3 VT	722									CKNC1-7 OH	270		
			1720	CBHT-3 NS	1170									CKSO1-3 OH	270		
			1730	CJCH-5 NS	1170									CKSO-5 OH	350		
			1757	CHSJ-4 NS	1085									Es 1945	KOA-4 CO	952	
			1830	CHAU-5 QB	1040									1949	KFVS-3 CO	837	
				CHSJ1-6 NB											KWGN-2 CO	952	
			2027	CJBR-3 QB	951										1958	KBMA-6 CO	952
	Tr	2100	WUTV-29 NY	445										2001	KDUH-4 NE	767	
			WKBN-27 OH	420										Tr	2008	CHLFT-25 OH	410
			Es	2127	CJCH6-6 NS									Es	2008	KYCU-5 WY	900
															2018	KFWO-2 WY	947

## William J. Draeb (continued)

July	22	Es	1705	WJXT-4 FL 1039	25	Es	2035	CBHT-3 NS 1170
14 Tr 2031	WFMJ-21 OH 420			WESH-2 FL 1130		2050	WGBD-2 SC 916	
	WKBN-27 OH 420		1725	WBAK-3 FL T			WCAY-3 NC T	
Es 2033	KOTA-3 SD 776			WKRQ-5 AL T		2054	CHSJ-4 NC 1085	
2053	KID-3 ID 1214		1730	WSB-2 GA 768			WCIV-4 SC T	
2055	KTVX-4 UT 1264			WAGA-5 GA 768		2058	CJBR-3 QB 951	
2107	KUTV-2 UT 1264		Tr 2005	KMPC-27 MO 588		2119	WLBZ-2 ME 925	
2150	KALD-4 ID 1424			KCBJ-17 MO 450			CKGW-2 NB 1117	
15 Tr 1758	KTIN-21 IA 365			WKPC-15 KY 432		2131	WCAK-3 VT 722	
	KSIN-27 IA 463			WLKY-32 KY 432		2154	WEHR-2 MA 840	
	WKBN-27 OH 420			WDRB-41 KY 432		Tr 2154	WKYT-27 KY 473	
	WFMJ-21 OH 420		2019	KOZE-24 MO 588		Es 2232	KYW-3 PA 705	
	WYTV-33 OH T		2119	KHIN-36 IA 457		2235	WBZ-4 MA 840	
	WVU-33 WV 498		2121	KLIN-32 IA 476			WCBS-2 NY T	
2014	KTCL-17 MN 280		2123	KEMA-44 MO 525			WNBC-4 NY T	
	KAVT-15 MN 288			KYNE-26 NE 481		26	1753 KYW-3 PA T	
	"both rare here"		2321	KTVJ-16 MO 633		1800	KRTV-3 MT 1157	
2014	KMBG-14 IA 463		2329	KGPT-19 MO 525			KCLL-4 MT 1219	
2332	CICO-24 OH 583		23	0818 KTVJ-16 MO 633		1830	KTVM-6 MT 1219	
	WYTV-33 OH 420			0836 KMPC-27 MO 588			KTV-2 UT T	
	WJBT-24 PA 405			0840 KTSB-27 KS 560		1858	CFRN-3 AT 1320	
	CHSN-22-22 OH 413			0849 WKYT-27 KY 473		1910	CITV-4 AT	
2357	WSRB-35 PA 405			WLPE-49 IN 319			Lloydminster 1175	
0018	CHLPT-25 OH 410			WFIU-30 IN 376			"saw local wx report	
0602	CHLPT-25 OH 410			WLKY-32 KY 437			at 1914; wx girl	
	CHLPT-1-8 OH 368			WDRB-41 KY 437			giving forecast...	
	CKWC-9 OH 350			WEHT-25 IN 420			called station for	
0620	GIGA-19 OH 410		Es 1430	unIDs 2-4 S.			confirmation of re-	
Es 2118	WGBD-2 SC 916		Tr 2044	WFIR-14 IN 420			ception and wx girl	
2127	WCIV-4 SC 916		2115	WKPC-15 KY 437			answered phone. She	
2139	WVAJ-3 NC 882		2332	KDNL-30 MO 432			said the stn has	
17 1350	WRDU-3 FL 1192			WFMJ-21 OH 420			been on for about	
	WSAV-3 GA T			WKBN-27 OH 420			two months."	
1355	WTVJ-4 FL T		2334	KSIN-27 IA 463		2015	WRGB-3 TN T	
1408	WJXT-4 FL 1039			KTIN-21 IA 365			WPBT-2 FL 1372	
Tr 2020	Youngstown U's			KYIN-24 IA 300		2030	WSB-2 GA 768	
	WUTV-29 NY 445		24	0000		2036	WUNC-4 NC 749	
2041	WQXI-16 PA 480			0008			WVAJ-3 NC 882	
2052	WJAN-17 OH 395			0537			WBCT-6 NC 882	
18 2015	CHFD-4 OH 300			0546		2040	WGBD-2 SC 916	
	DuLuth V's 286			0900			WCIV-4 SC 916	
2310	CHLPT-13 OH					2050	WESH-2 FL 1130	
	Geraldton 415					2100	WJXT-4 FL 1039	
	"WVU-13 off"					2335	unID 2-4 N.W.	
2315	CHLPT-8 OH 368					27	1135	
2345	CHLPT-3 OH 270						KAMR-4 TX 991	
2055	WUTV-29 NY 445						KBNW-3 NM 1103	
	WFMJ-21 OH 420						1159	
	WKBN-27 OH 420						KATC-3 IA 1026	
	WJBT-24 PA 405						1200	
	WJAN-17 OH 395						KOA-4 CO T	
	WOSU-34 OH 395						1215	
2108	WYTV-33 OH 420						KDFW-4 TX 957	
2113	WSRB-35 PA 405						KKAS-5 TX 972	
	WQIX-54 PA 405						1253	
	KHIN-36 IA 457						KMTD-2 TX T	
21 0830	KFTN-21 IA 365					Tr 1950	WFMJ-21 OH 420	
	KSIN-27 IA 463						WKBN-27 OH 420	
	KYIN-24 IA 300						KTIN-21 IA T	
	KMBG-14 IA 463					Es 2003	WRDU-3 FL 1192	
	CHLPT-25 OH 410						WESH-2 FL 1130	
0855	Buffalo U's						WPBT-2 FL 1372	
1234	WKYT-27 KY 473						WGBD-2 SC 916	
22 0651	WJBT-24 PA 405						WUFT-5 FL 1071	
	WKBN-27 OH 420						WDBO-6 FL 1164	
Es 1705	WHSB-2 FL 1372						2054	
	WRDU-3 FL 1192						WRHL-3 GA 853	
	WTVJ-4 FL 1372						2057	
	WUFT-5 FL 1071						WBAK-3 FL T	
	WPTV-5 FL 1305						2100	
							WCIV-4 SC 916	
							WSAV-3 GA 933	
							28 Tr 2025	
							WQIN-54 PA 405	
							WJBT-24 PA 405	
							WHAG-25 MD T	
							2115	
							CHLPT9-68 ON T	
							"are they on yet??"	

## William J. Draeb (continued)

July		31 Es		2024		31 Es	
28 Tr	2142 KDL-30 MO 432	1218	KPTX-3 TX 1079	2024	KAMB-4 TX 991	2037	KIMB-3 NB T
	2147 WMUL-33 WV 498	1220	IBFB-3 NL T	2200	KIII-3 TX 1295	2231	KJAC-4 TX T
Es	1230 WRBL-3 GA 853	1230	KPRC-2 TX 1118	<b>August</b>			
	WBDO-3 FL 1192		KJAC-4 TX 1080	1 Es	*unIDs on ch 2-4*		
	WDIQ-2 AL 925	1249	KENS-5 TX 1213	2	2000	CJBR-3 QB 951	
	WTVY-4 AL 934	1550	WCBD-2 SC 916		2045	CHAU-2 QB T	
1248	WJXT-4 FL T	1600	WRC-4 DC 650		2117	CFCM-4 QB 803	
	1327 WRAR-3 FL 986		WHSV-3 VA		2124	WCAX-3 VT T	
29	1600 WPHB-2 FL T		Harrisonburg 620			CBHT-3 NS T	
	1630 CBHT-3 NS 1170	1610	WTAR-3 VA 785		2137	CBFT-2 QB 690	
	CHSJ-4 NB 1085	1620	WTAR-4 PA		2200	CJCB-4 NS 1350	
	CJCB-4 NS 1350		Pittsburgh 480		2225	CBVT2-3 QB 756	
1700	CJBR-3 QB 951	1629	WUNC-4 NC 749		1100	KATC-3 LA 1026	
1723	CBIT-5 NS T		WTVR-6 VA 710	3	1230	WTVY-4 AL 934	
1725	CJCB1-6 NS	1634	WRAL-5 NC 764		1300	KTBS-3 LA 901	
1800	CFCM-4 QB 803	1641	WUND-2 NC T		1600	WMAB-2 NS 784	
2315	CHSJ-4 NB 1085	1658	WMAX-3 NC 882			WBI-4 NS 770	
	CBHT-3 NS 1170	1700	WBTY-3 NC 736			WBRZ-2 LA 1002	
	CJCB-4 NS 1350	1715	WCIV-4 SC 916		1630	WUNC-4 NC 749	
	CBIT-5 NS 1350		WTVZ-4 SC T		1636	WCIV-4 SC 916	
2330	WCAX-3 VT T	1728	WSAV-3 GA 933		1640	WVAY-3 NC 882	
	CJCB-5 NS 1170	1730	WJXT-4 FL 1039		1655	WBDO-3 FL 1192	
	*Es-Au combination;	1800	WNL-4 LA 1028		1730	WUPB-5 FL 1071	
	unID ch 4 north*		WRAR-3 FL 986		1801	WRAL-5 NC 764	
30	0056 KAID-4 ID T		WKRK-5 AL 967			WECT-6 NC 882	
	1659 WCBD-2 SC 916		WBRZ-2 LA 1002		2015	KBSW-3 NM 1103	
	WBDO-3 FL T		WCTV-6 FL 972			KRID-2 TX 1176	
	WRBL-3 GA T	1803	KALB-5 LA 961		2050	KAMB-4 TX 991	
Tr	2000 WKYT-27 KY 473		KATC-3 LA T			KATC-5 TX	
	WMUL-33 WV 498		WDSU-6 LA 1028			Lambert 1105	
	2055 WOSU-34 OH 395	1808	WBRG-6 AL T		2125	KPRC-2 TX 1118	
31	0835 Youngstown U's	1830	WMAB-2 MS 784			KPTX-3 TX 1079	
Es	1100 WTVY-4 AL 934	2000	KTBS-3 LA 901	4	1900	WBDO-3 FL 1192	
	1103 WBDO-3 FL T	2001	KATC-3 LA 1026				
	1159 KIII-3 TX 1295	2010	KENW-3 NM 1103				
	1200 KGBT-4 TX 1400						

\*In last month's report I said WABO-12's tower was blown down. Apparently, it wasn't that bad. They returned to the air the following day. I also noted on 7-29 before CHSJ-4 signed off they put a slide on showing their repeater stations. One of them was on ch 4 in Campbellton, NB. Has anyone seen this one?\*

## Donald B. Ruland 4448 68th Place Kenosha, Wisconsin 53142 (CDT)

June		21 Tr		26 Tr		July	
8 Es	0628 WBRZ-2 ME 950	0700	WUAB-43 OH 330	0600	WKYT-27 KY 360		
10 Tr	0555 WLKY-32 KY 330	Es	1815 WBDO-3 FL 1070		WAKR-23 OH 340		
	WAAY-31 AL 550		1830 WJXT-4 FL 920				
	0630 WYUR-48 AL 560		1900 WSSH-2 FL 1020		8 Tr	0600 WKRN-27 OH 380	
	WKYT-27 KY 360	23	1900 KATC-3 LA 900			WTVY-33 OH 380	
	0640 WMBG-42 AL 640	26 Tr	0550 WPGH-53 PA 430			WAKR-23 OH 340	
13 MS	0527 WTAE-4 PA 430		0600 WUAB-43 OH 330			WHIZ-18 OH 360	
21 Tr	0700 WVIZ-25 OH 330		WLKY-32 KY 330				

\*Log remains at 439\*

## Dean R. Markoshan 10636 Avenue "B" Chicago, Illinois 60617 (CDT)

\*In retrospect, July was one of the most productive months in my short DXing career. In order not to bore the readership with countless reloggings, I will only list my new findings henceforth. Some of the Es was so potent that it actually engulfed locals WBBM-2 and WMAQ-5, eventually consuming WLS-7 as well. Without the undivided attention of my fiancée, Mary, many of these memorable sightings would not have been possible. Good DX to all.

July		26 Tr		31 Es	
18 Tr	0200 KMOX-4 MO	0730	KPLR-11 MO	1732	KGBT-4 TX
24	0230 WNEB-5 MI	0735	WBBM-25 IN	1745	KRGV-5 TX
25 Es	1800 KOTA-3 SD	29 Es	1825 WFL-4 LA	1738	KENS-5 TX
	KDUE-4 NE	31	0155 KMOL-4 TX	1900	KRIS-6 TX
	1900 CBOT-4 ON		0204 KFDD-3 TX		KBTX-3 TX
	1916 KDSJ-5 SD		0243 KACB-3 TX		
			1730 KIII-3 TX		

Present log total: 129



Jim Gould R.R.#3 Kokomo, Indiana 46901 (317)452-9585 (GDT)

July	4	Es	0121 unID-3 "ad for Austin & San Antonio stores; video was covered by a second station...stn w/San Antonio ad was zero or minus offset... nothing correlates w/Station Guide... weak signals might not rule out low power translators"	8	Tr	0715 WVUU-24 WV 332			
1	Es	1735 unID-2 WSW				0720 WSBA-43 PA T			
		1745 WBRZ-2 LA T				0722 WBFF-45 MD 508			
		1750 WDIQ-2 AL 648				0730 WVIA-44 PA 540			
		1825 WSAV-3 GA 655				1900 WICU-12 PA 338			
		1830 WEAR-3 FL 710				1930 WUTV-29 NY T			
		1844 KATC-3 LA 793				2000 unID-29 NBC			
		"wierd opening!"				"E.S.R." (WVIR? -bt)			
		1900 KMID-2 TX 1087				2050 "CCI from			
		2000 KGBT-4 TX 1230				WBRZ-28, WSBA-43,			
		2010 WPBT-2 FL 1090				WBFF-45, WKBS-48,			
		2020 WDSU-6 LA T				and unknown CCI on			
		2032 XEPE-2 Tams 1187				ch 53 10kc w/WPGH"			
		2050 KACB-3 TX 1020	Tr	0850	KDIN-11 IA 390	9	Es	1730 KMID-2 TX 1087	
		2200 KIII-3 TX 1102			KMEG-14 IA 540			1810 XEPE-2 Tams T	
		2234 KWGN-2 CO T			KHIN-36 IA 470			1820 KRNW-3 NM T	
2	Tr	0833 WAAV-31 AL 410			WHO-13 IA 390			1830 WBSN-2 FL T	
	Es	1250 KWGN-2 CO T			"under local"			2140 KWGN-2 CO 990	
		1650 WEDU-3 FL T			0901 KTTC-10 MN 396		10	Tr	0720 "very strong
		1730 KMID-2 TX 1087			0912 KCCI-8 IA 390				signals from Erie
		KENW-3 NM 1035			0918 KOLR-10 MO 440				PA thru MI, WI & IL"
2Es		1802 WTPM-3 PR	Es		0957 CHAU-2 QB				1030 KOLR-10 MO 445
		Mayaguez 1900			Ste Marguerite-Marie 600				2102 KENW-3 NM T
	Es	1850 KWGN-2 CO 990			0958 CJBR-3 QB 1020				1234 WPBT-2 FL 1090
		1900 WPBT-2 FL 1090			1030 KOTA-3 SD 940				1330 KTWO-2 WY 1090
		1913 "Cuban ch 3"			1040 KWGN-2 CO T				1340 WTVJ-4 FL 1090
		2000 WTVJ-4 FL 1090			1100 KDIX-2 NC 970				WEDU-3 FL T
		2002 WPTV-5 FL 1015			1200 KDSJ-5 SD T				1704 WPBT-2 FL T
		2026 WCIX-6 FL 1090			1610 KGFE-2 ND 685				1705 TV Gibana-3 1300
		2052 WBSH-2 FL T			1646 CHHT1-3 NS				1707 WCIX-6 FL T
		2350 unID-2 MEXICO			Yarmouth 1050				1753 CKCK-2 SK 1120
3		0048 KRNW-3 NM 1035	Tr	1920	KOLR-10 MO 440				1800 CKBQ-2 SK 1225
		0150 unIDs 2 & 3 W.			2000 WHO-13 IA 390				1900 WDIQ-2 AL 648
	Tr	0308 WABO-12 WI 385			"thru local"				WUPT-5 FL T
		0315 KYTV-3 MO 440			2002 KYIN-24 IA 402				1901 WBRZ-2 LA T
		0316 WRBC-3 TN T	Es	2010	XEPM-2 Chih T				unID-5 Spanish
	Es	1000 WPBT-2 FL T			1659 CHAU-2 QB 700				1930 KATC-3 LA 793
	Tr	1030 WAAV-31 AL R	5		1722 CJBR-3 QB 1020				1941 unID-3 N.W. FF
	Es	1030 unID-3 Spanish	Tr	2100	WLOS-13 NC 400				1952 unIDs 3 & 4 N.W.
		1116 unID-4 Spanish			2115 WAAV-31 AL 410				"football"
		"minus or plus off-			WFIQ-36 AL 405				2000 KPRC-2 TX 920
		set...appears to be			WYUR-48 AL 410				2030 KTVQ-2 MT 1220
		more than 10 kc."			2140 WATI-36 GA 485				2031 KXLF-4 MT 1372
		1629 KJAC-4 TX 865			2230 WHAB-46 GA 485				2040 KMOL-4 TX T
		1743 KXJB-4 ND 685			2232 WTCG-17 GA 485				KENS-5 TX T
		1753 WBRZ-2 LA 760			2303 WEMG-42 AL 490				2130 KID-3 ID 1330
		1758 WWL-4 LA 770			2311 WZTV-17 TN 315				2140 KACB-3 TX T
		1842 KWGN-2 CO T	6	Es	1800	KCBS-2 NY 640			2200 KYCU-5 WY 970
		1844 KOA-4 CO T			KYW-3 PA 573				2230 WUND-2 NC -
		1900 WDIQ-2 AL 648			1830 WTAR-3 VA 590				Columbia 632
		WESE-2 FL T	Tr	2225	WAAV-31 AL 410				0625 WTCN-11 MN 480
		2000 WPBT-2 FL 1090			2230 WEMG-42 AL 490				"thru Chicago"
		2002 WEDU-3 FL 925	7		0704 WAAV-31 AL 410				0632 KTTC-10 MN 396
		WTVJ-4 FL 1090			0710 WEMG-42 AL 490				WHO-13 IA 390
		2004 WCIX-6 FL T	Es	1720	WLBZ-2 ME 925				2040 WUTV-29 NY 404
		2005 unID-5 Spanish			1730 CJBR-3 QB 1020				2102 WENY-36 NY 490
	Tr	2008 KOLR-10 MO 440			CJCB-4 NS 1240				0445 CFPO-9 ON 410
	Es	2100 "still in ch 6			WABT-5 ME 925				0500 CKSQ1-3 ON
		deep; but being push-			CJCB1-6 NS 1320				Elliot Lake 432
		ed out by increasing			1800 CRHT-3 NS 1170				CKCO-13 ON 350
		tropo signals semi-			1900 CHSJ-4 NB 1150				CJOH-13 ON -
		locally"			WGEE-2 MA 785				Ottawa 623
	Tr	2120 WAAV-31 AL 410			2000 CBIT-5 NS				0506 WBRZ-28 PA 540
	Es	2200 WDSU-6 LA 770			Sydney 1240				0507 WNEP-16 PA 540
		"on vertical antenna"			2020 WCVB-5 MA 785				0516 WSYR-18 NY
		2252 KBTX-3 TX 900			2032 WCBS-2 NY 640				Elmira 490
		2258 KATC-3 LA 793	8	Tr	0622	WICZ-40 NY 537			"covered by CIC018
4	Tr	0045 KYTV-3 MO 440			0623	WENTY-36 NY 490			at 0518"
		WRBC-3 TN T			0659	unID-41 E.S.E.			0520 WICZ-40 NY 537
		KTVO-3 MO 330			(W41AA Wheeling? -bt)				0536 WHEC-10 NY 477

**Jim Gould (continued)**

**July**  
 14 Tr 0544 **WUPR-20 NY**  
 Utica 584  
 0618 **WBNY-36 NY** 490  
 Es 1827 **KMID-2 TX** 1087  
 1957 **KOTA-3 SD** 940  
 1958 **KDIX-2 ND** 970  
 1959 **KTVO-2 MT** 1220  
 2115 **KXLE-4 MT** 1372  
 Tr 2330 **WBNY-36 NY** 490  
 15 0900 **KYIN-24 IA** 402  
 Es 2130 **KDIX-2 ND** 970  
 17 Tr 0230 **WWUP-10 MI** 422  
 0930 **WAAY-31 AL** 410  
 0931 **WYUR-48 AL** 410  
 Es 1729 **KMID-2 TX** 1087  
 1800 **WBRZ-2 LA** T  
 18 Tr 0445 **KDKA-2 PA** 320  
**WOAY-4 WV** 300  
**WATB-6 TN** 346  
**WBIR-10 TN** 346  
 0910 **WVUV-24 WV** 332  
 0912 **WUTV-29 NY** T  
 0915 **WBRB-28 PA** T  
 0930 **KOLR-10 MO** 445  
 Es 0944 unID-3 Spanish  
 1010 **WPBT-2 FL** T  
 1130 "into Texas,  
 ch 5 deep"  
 Tr 2130 **WUTV-29 NY** 404  
 2330 **CITY-79 OH** 410  
 19 0545 **KBMA-41 MO** 458  
 0549 **KMTC-27 MO** 445  
 0551 **KTSB-27 KS** 510  
 0900 **WHD-13 IA** 390  
**KDIN-11 IA** 390  
 20 Es 1600 "to CUBA ch 3"  
 Tr 2230 **WUTV-29 NY** 404  
 21 Es 1630 **XEPB-3 FL** T  
 1810 **XEPB-2 Tams** T  
 22 Tr 2200 **WHD-13 IA** 390  
 "thru local"  
**KTTC-10 MN** 396  
 2230 **KHIN-36 IA** T  
 2345 **KBMA-41 MO** 458  
 23 0102 **WTCN-11 MN** 466  
 0107 **KMBC-9 MO** 458  
 0136 **WDAF-4 MO** 458  
 0141 **KAKB-10 KS** 642  
 0147 **KMTC-27 MO** T  
 0152 **KTVE-12 KS** 660  
 0542 **KCMO-5 MO** 458  
 0543 **KYTV-3 MO** 445  
 0545 **KBMA-41 MO** 458  
 0553 **WTVK-26 TN** 346  
 0554 **KTVE-12 KS** 660  
 0610 **KQTV-2 MO**  
 St Joseph 458  
 0614 **WJHL-11 TN** 360  
 0618 **WLBW-13 KS** 510  
 "over local"  
 2000 **WHLA-31 WI** 339  
 24 0555 **WRFF-45 MD** 508  
 0556 **WDCA-20 DC** 492  
 0601 **WNEP-16 PA** 540  
 0602 **WBOC-16 MD**  
 Salisbury 580  
 0635 **WETA-26 DC**  
 Washington 492  
 0639 **WHAG-25 MD** 445

29 Es 1246 unID-3 south  
 "Spanish—not CUBA"  
 1256 **WBAR-3 FL** T  
 1309 **KIII-3 TX** 1102  
 1326 **XEPB-3 FL** 1312  
 1430 **KBTB-4 TX** 1230  
**KRGV-5 TX** 1230  
 1605 "intense from  
 ENE, ESE, SW & W."  
 1700 "mostly gone  
 with **WBAR-3** &  
 Maritime Canadian  
 on ch 2"  
 1728 **WBRB-5 AL** 700  
**WBRZ-2 IA** 760  
 1730 "ATV channels  
 2, 3 & 4 Maritime  
 Canadians"  
 1740 **CHAU-5 QB**  
 "cut to supper at  
 1745; back at 2027;  
 Es ch 6 deep into  
 Texas with ch 2 to  
 NW...Es to E gone"  
 2030 **KRGV-5 TX** 1230  
 "test pattern"  
 30 Tr 1049 "Ames & Des  
 Moines IA VHF's  
 under locals (400m)  
 31 Es 1059 **KGBT-4 TX** 1230  
 1100 **KRGV-5 TX** 1230  
 1200 **KXAS-5 TX** 800  
**KCHN-6 TX** T  
 1800 "channel 6  
 deep...2 & 3 stations  
 toward Texas  
 2300 unID-2 west  
 "EGADS, WHAT A WAD!"

WV shares 4



**WHBF TV 6**



**WQAD-TV 8**

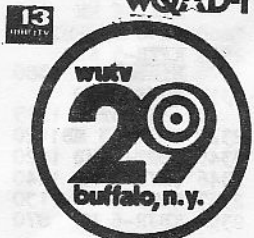

David J. Egan 9-321 Jeanne Mance Valleyfield, Quebec J6T 5S2 (514)373-4374	
May (all times EDT)	7 Es 0057 WDAF-4 MO 1115
29 Es 2346 unID-2	0629 unID-2 o/CBFT
30 0006 unID-3	0723 unID-6 NBC +
1620 WJXT-4 FL 1100	1230 CKPR-2 ON
1628 WSAV-3 GA 975	Thunder Bay 775 10
1704 WDAF-4 MO 1115	"strong CBC color & audio over CBFT" 11
1718 KTVO-3 IA 965	1239 CHFD-4 ON 775 12
June	1243 CBWFT-3 MB 1120
2 Es 1205 WRDU-3 FL 1270	"...for eight years I couldn't get it & this year I have it showed down my throat every time I turn on channel 3"
1209 WTVJ-4 FL 1365	1245 CBWFT-4 MB 1050
1220 WCBD-2 SC 910	1759 KTCA-2 MN 920
1221 WSAV-3 GA 975	1806 KGFE-2 ND 1215
1222 WCIV-4 SC 910	1813 CBWFT-3 MB 1120
1227 WJXT-4 FL 1100	1841 CKYB-4 MB 1240
1240 WFMY-2 NC T	1848 CKX-5 MB 1240
1620 WSAV-3 GA 975	1852 CBWT-6 MB T
1646 WJXT-4 FL 1100	1230 WBHM-2 IL T
3 1105 unID-3 "Spanish"	WMT-2 IA T
1219 WSB-2 GA 955	KTVO-3 IA T
1810 unIDs to ch 4	WHBF-4 IL T
6 1810 "Es right thru ch 6; 2 or 3 thick on chs 5 & 6, as many as 7 or 8 thick on lower channels..."	KTIV-4 IA T
1811 WJXT-4 FL 1100	1455 CBWFT-3 1120
WTVJ-4 AL 1155	1800 KUSD-2 SD T
1813 WCCO-4 MN 920	1859 KTVO-3 IA 965
1822 unID-6 o/CBMT	1900 KTVI-2 MO 945
1829 KKON-5 SD 1215	1901 KTCA-2 MN 920
1835 unID-7 "super rolling bars o/CBMT for over one minute -no ID"	1904 WCCO-4 MN 920
1852 KAAL-6 MN T	1905 "CBFT obliterated in all directions for first time in several years..."
1859 KDLO-3 SD 1130	1912 WHBF-4 IL 865
1907 KCMO-5 MO 1115	1913 KTIV-4 IA 1105
1920 KDAL-3 MN 870	1915 KGLO-3 IA 970
1924 KTVO-3 IA 965	KMTV-3 NE 1125
1927 KMOX-4 MO 945	1928 WOI-5 IA "so strong that WPTZ could not be detected..."
1932 WOC-6 IA Davenport 935	1939 WOC-6 IA T
"wiped out CBMT with color...confirmed"	2025 KSNB-4 NE 1300
1938 KMTV-3 NE 1125	2037 WMT-2 IA T
1955 WOPF-6 NE 1125	2038 WOVW-6 NE 1125
1956 WMAQ-5 IL T	2047 KHAS-5 NE 1300
2000 KHAS-5 NE 1300	2050 KLINE-3 NE 1320
2129 CKCK-2 SK 1430	2100 WMT-2 IA 900
2159 KDAL-3 MN 870	KUSD-2 SD 1225
2210 KBJR-6 MN T	2108 KQTV-2 MO 1125
2215 CBWT-6 MB T	1216 KHAS-5 NE 1300
2218 WDAY-6 ND 1095	1218 KMTV-3 NE 1125
2231 KDAL-3 MN 870	1219 KLINE-3 NE 1320
"dominating w/3 or 4 others..."	1231 KSNB-4 NE 1300
2249 WCCO-4 MN 920	1420 CBWFT-3 MB 1120
2256 KSTP-5 MN 920	1426 CKYB-4 MB 1240
2300 KTCA-2 MN 920	1430 CKX-5 MB 1240
KAAL-6 MN 920	CBWT-6 MB T
"moderate o/CBMT"	1703 CBWFT-3 MB 1120
2304 KFYR-5 ND Bismarck 1380	1706 CKCK-2 SK 1430
2318 KGFE-2 ND Grand Forks 1215	1709 KGFE-2 ND 1215
2320 CBWFT-3 MB 1120	1726 CKOS-3 SK Yorkton 1500
2345 CBWT-6 MB 1120	1734 CKMT-4 SK Moose Jaw 1650
2346 CKYB-4 MB 1240	
2357 KDLO-3 SD 1130	
2358 KBJR-6 MN 870	
	9 Es 1813 unID-7 "rolling bars o offset for 30-40 seconds, no IDs"
	1513 unID-3 CBC ADT
	0824 unID-5 "weak"
	1138 WCCO-4 MN 920
	1140 "all lowband chs obliterated"
	1147 KTCA-2 MN 920
	1200 KDAL-3 MN 870
	1201 KBJR-6 MN 870
	KCMO-5 MO 1115
	1228 CKPR-2 ON 775
	1739 KDLO-3 SD 1130
	1744 KPRY-4 SD Pierre 1385
	1756 KKON-5 SD 1215
	1804 KPLO-6 SD Reliance 1350
	1808 KUSD-2 SD 1225
	1809 WCCO-4 MN 920
	1824 KDAL-3 MN 870
	1829 WJMN-3 MI 625
	1838 KBJR-6 MN 870
	1839 KSTP-5 MN 920
	1841 unID-7 "o CCI weak for under one minute w/no ID"
	1849 KGFE-2 ND 1225
	1850 CKPR-2 ON 775
	1855 KXJB-4 ND 1150
	1904 CBWFT-3 MB 1120
	1907 CHFD-4 ON 775
	1058 unIDs to 5
	1200 unIDs to 6
	1708 WSAV-3 GA 975
	1719 WSEB-2 FL 1185
	1723 WCBD-2 SC 910
	1729 WJXT-4 FL 1100
	1736 WJBF-6 GA 910
	1737 WPTV-5 FL 1335
	1758 WUPT-5 FL 1190
	1748 WRBC-3 TN 1095
	1758 WFBT-2 FL 1380
	1814 WNL-4 IA 1385
	1830 WTVJ-4 AL 1145
	1832 WTVJ-4 FL 1380
	1841 WSEB-2 FL 1185
	1846 WSCS-5 SC 910
	1900 WLBT-3 MS 1255
	1058 WMAB-2 MS 1180
	1159 WNGE-2 TN 910
	1200 WRBC-3 TN 1095
	WSN-4 TN 910
	1210 WGBT-4 MS 1110
	1212 "Es was up as high as 90.3 on FM ... then faded out"
	2100 WPBT-2 FL 1370
	1858 WSAV-3 GA 975
	1900 WDIQ-2 AL 1180
	1903 WEAR-3 FL 1250
	1231, 1245 unIDs 3
	1810 t/in; MUF 105.7
	1856 WBTW-3 NC 785
	1900 KCMO-5 MO 1115
July	
1 Es 1829 WRDU-3 FL 1270	
1830 WPTV-5 FL 1335	



David J. Egan (continued)

July					
1	Es	1834	WTVJ-4 FL	1370	
		1950	MUF 107.5	FL	
2		1728	WTVJ-4 FL	1370	
		1730	WPTV-5 FL	1335	
		1731	WCIX-6 FL	1410	
		1732	WFBT-2 FL	1370	
		1751	unID-5	Spanish	
		2040	KYTV-3 MO	1135	
		2056	KTFW-2 OK	1345	
		2130	KTVY-4 OK	T	
		2153	WEDU-3 FL	1270	
		2158	WSAV-3 GA	935	
		2202	WUFT-5 FL	1190	
		2206	WJXT-4 FL	1100	
3		1359	WEDU-3 FL	1270	
		1900	WEDU-3 FL	1270	
		1911	WMT-2 IA	900	
			"super color o/CBPT"		
		1912	WHBB-4 IL	865	
		1919	KUSD-2 SD	1225	
			KTIV-4 IA	1105	
		1922	KTCG-2 MN	920	
		1944	KGFB-2 ND	1215	
		1945	KDLO-3 SD	1130	
		2013	KMTV-3 NE	1125	
			KQTV-2 MO	1125	
		2030	MUF to 90.3		
		2058	WOL-5 IA	1015	
4		0053	unID-2		
		1210	KMIV-3 NE	1125	
		1213	KHAS-5 NE	1300	
		1224	WDAR-4 MO	1115	
		1237	QBWTE-4 MB	1050	
		1425	MUF to 92.5		
		1429	WGCO-4 MI	920	
		1448	KBJR-6 MI	870	
		1459	KLFB-4 ND	1150	
		1504	KFYR-5 ND	1380	
		1506	KDAL-3 MI	870	
		1632	KARD-3 KS	1340	
		1637	KQTV-2 MO	1225	
		1638	KCKR-2 KS	1365	
		1710	KSNB-4 NE	1300	
		1740	"MUF knocking		
			the bottom out of		
			FM; unID-7 heavy $\phi$		
			rolling bars for 40		
			seconds solid"		
		1830	MUF to 90.5		
		1858	WRAR-3 FL	1250	
		1859	WTVY-4 AL	1145	
		1906	WKRG-5 AL	1265	
7		1150	"lowband south		
			Florida strong"		
		1545	"joined in		
			w/MUF high in FM"		
		1545	WUFT-5 FL	1190	
		1549	"perhaps double		
			hop in SS at around		
			89.9...Puerto Rico		
			mentioned several		
			times..."		
		1603	WEAR-3 FL	1250	
		1618	WCIV-4 SC	890	
		1647	"the loudest Es		
			I've ever heard..."		
			past 107.9 on FM..."		
			GB Es past 108.1 w/		
			skip drone from		
			time to time..."		
7	Es	1650	WUNC-4 NC	700	
		1651	unID-7	"super	
			rolling bars for a		
			minute or more o/CBPT"		
		1653	WITV-7 SC	T	
			"w/Sesame St. but		
			f/out before ID..."		
			Charleston dominat-		
			ing 2, 4 & 5 reinfo-		
			ring my ch 7 belief"		
		1715	unID-7	"- off-	
			set CGI for 40 sec"		
		1740	"ch 2 was 6 or		
			7 thick...ch 6 was		
			2 or 3 thick...FM		
			knocked out past		
			107.9 & there was		
			periodic Es on ch 7"		
		1755	WCYB-5 TN	740	
		1802	WTAR-3 VA	605	
		1807	WRAL-5 NC		
			Raleigh 930		14
		1843	WTPG-5 DC		16
			Washington 455		17
			"the shortest Es		
			ever viewed here..."		
			confirmed recently"		
		1845	WOAY-4 WV	T	21
		1850	"Es finally		23
			dropping back to		
			107 MHz FM MUF"		25
		1906	KDAL-3 MI	870	
		1912	WCOC-4 MI	920	26
		1913	KBJR-6 MI	870	
		1925	WSAV-3 GA	965	
		1928	WCSC-5 SC	890	
		1929	WUNC-4 NC	700	
		1930	WCIV-4 SC	890	
			WJXT-4 FL 1100		
		1945	"MUF thru 107.9		
			again..."		
		2000	WTAR-3 VA	605	
		2018	WJRP-6 GA	910	
		2030	WCSC-5 SC	890	
		2108	WBRC-6 AL	1050	
		2131	WTVY-4 AL	1145	
		2140	"MUF low in		
			educational FM band"		
		2141	WKRG-5 AL	1265	
		2143	WRBL-3 GA	1135	
		2149	WDIQ-2 AL	1180	
		2233	WMT-2 IA	900	
		2240	WKRM-2 IA	705	
		2241	WGLO-3 IA	965	
			WTMJ-4 WI 700		
		2242	WOL-5 IA	1015	
		2244	WOC-6 IA	935	
		2300	"Es finally		
			petered out on low-		
			band—one of the		
			most extensive open-		
			ings encountered..."		28
			best Es ever seen		
			in 15 years"		
		1230	WCBD-2 SC	890	8
		1502	WMT-2 IA	900	
		2150	WTWO-2 IN	790	29
		2315	WCIA-3 IL	795	
		1128	WSB-2 GA	955	
		1130	WRBC-3 TN	1095	
12	Es	1132	WMC-5 TN	1095	
		1133	KSNB-4 NE	1300	
		1159	KCKR-2 KS	1365	
			KQTV-2 MO 1225		
		1226	KARD-3 KS	1345	
		1757	WPTV-5 FL	1335	
		1809	WOWT-6 NE	1125	
		1813	WHL-4 LA	1385	
		1828	KDLO-3 SD	1130	
		1831	KXON-5 SD	1215	
		1856	WKRG-5 AL	1265	
		1858	WRAR-3 FL	1250	
		1900	WBRC-3 TN	925	
		1902	WSAV-3 GA	965	
		2000	MUF 107.9		
		2003	WJXT-4 FL	1100	
		2059	KTVY-4 OK		
			KCOG-5 OK		
		2112	CBWFT-3 NB	1120	
		2115	KOPB-2 ND	1215	
		2126	KYTV-3 MO	1135	
			unID-2 weak		
		1020	unIDs 2 & 5		
		2308	unID-2 CTV		
		2325	unID-5 French		
		1829	WEDU-3 FL	1270	
		1834	WESH-2 FL	1185	
		1808	unIDs 2,3 S.E.		
		1225	unID 2-4 weak		
		1830	unID-2 weak		
		1159	WKRG-3 GA	1135	
		2129	WHL-4 LA	1385	
		1722	KFFB-5 ND	1380	
		1731	KJJB-4 ND	1150	
		1754	KDLO-2 ND		
			Mckinson 1500		
		1811	WOAY-3 NC	790	
		1822	WCIV-4 SC	890	
		1858	WTWO-2 IN	790	
		1859	KDLO-3 SD	1130	
		1901	KARL-5 AR	1200	
		1910	KFSM-4 AR	1265	
		1914	WCRT-4 MS	1110	
		1939	WBRC-3 TN	1095	
		1157	WEDU-3 FL	1270	27
		1218	KTVI-2 MO	945	
		1529	WTVJ-4 FL	1370	
		1656	WCBD-2 SC	890	
		1700	WESH-2 FL	1185	
		1706	WYAY-3 NC	790	
		1752	WCSC-5 SC	890	
		1807	WCIV-4 SC	890	
		1829	WJXT-4 FL	1100	
		1831	WUFT-5 FL	1190	
		1843	WBRC-6 FL	1225	
		1859	WRBL-3 GA	1135	
		1900	WJBP-6 GA	910	
		1904	WTVY-4 AL	1145	
		1935	WRAR-3 FL	1250	
		1936	WEDU-3 FL	1270	
		1959	WTVJ-4 FL	1370	
		1128	WEDU-3 FL	1270	
		1130	WJXT-4 FL	1100	
		1505	"weak Es noted		
			to ch 4 in GA-FL-SC		
			region..."		
		1626	CJOX-3 NF	945	
		1635	CJON-6 NF	1050	
		1638	WCBD-2 SC	890	
		1643	CJCN-4 NF	875	

## David J. Egan (continued)

July	29 Es	1647	WUNC-4 NC	700	1656	CBNT3-5 NF	1700	KFTV-3 MO	1135	1702	CJOX-3 NF	1735	CJWH1-4 NF	Stephenville	750	"undercutting CFCW, + offset matching CBOT...800 watts"	1754	KQTV-2 MO	1125	1804	WGCO-4 MN	920	1823	CBWCT-5 ON	T	29 Es	1825	KDLO-3 SD	1130	1826	KHAS-5 NE	1300	1830	KMTV-3 NE	1125	CBWT2-4 MB	1831	CBWT-6 MB	T	1832	CBWFT-3 MB	1120	1834	KGFE-2 ND	1215	1837	WOWT-6 NE	1125	30	1846	KDAL-3 MN	870	1855	WDAY-6 ND	1075	1858	KTCA-2 MN	920	31	1900	KSTP-5 MN	920	29 Es	1906	unID-3	CBC	ADT	1926	WRGB-3 TN	925	1944	CJOXI-2 NF	820	1953	CBNAT1-3 NF	890	1955	CBNAT4-6 NF	St Anthony	880	"o/CBMT, ID as ch8"	1655	KEFS-2 AR	1198	1702	WBRZ-2 LA	T	1708	KTVI-2 MO	945	1709	KMOX-4 MO	945	1100	WPTV-5 FL	1335	1115	WTVJ-4 FL	1370
------	-------	------	-----------	-----	------	------------	------	-----------	------	------	-----------	------	------------	--------------	-----	---	------	-----------	------	------	-----------	-----	------	------------	---	-------	------	-----------	------	------	-----------	------	------	-----------	------	------------	------	-----------	---	------	------------	------	------	-----------	------	------	-----------	------	----	------	-----------	-----	------	-----------	------	------	-----------	-----	----	------	-----------	-----	-------	------	--------	-----	-----	------	-----------	-----	------	------------	-----	------	-------------	-----	------	-------------	------------	-----	---------------------	------	-----------	------	------	-----------	---	------	-----------	-----	------	-----------	-----	------	-----------	------	------	-----------	------

"I've changed location and the Es this year is simply unbelievable...on several occasions MUF has reached channel 7, although no positive IDs. With the logging of the low-powered relays in Newfoundland 7-29, 1977 seems to be heading into the record books as one of the most productive Es years I can remember. I've had no less than 4 new loggings over 1500 miles in distance this year, and with the 800 watt Newfie relay, I suppose this is my rarest catch ever (surpasses my double hop to Puerto Rico in 1974)...I think that this year's activity may approach the legendary 1950's when everyone was in on cross-continental Es. I was too small to know about it, but any DXers who went thru the time, your comments and comparisons would undoubtedly be interesting...At the end of July log total is 249, 122 of which are via Es. I've seen 111 Es stations in two months counting relogs...I'm averaging 95% confirmations for my reception reports this year...I photographed many ID slides, which will hopefully appear in PHOTO-NEWS in upcoming issues. Until next time, 73"

## Bob Seybold Bennett Road Dunkirk, New York (EDT)

"Here is some sort of a DX report for past 30 days; E-skip evident on a great many days in the period June 12 - July 15, especially in late June-early July."

- June
- 12 Tr "Hills DX-fair opening: WTAP-15 WNDU-16 WNEP-16 WJAN-17 CICO18-18 WSYB-18 WHIZ-18 WKON-20 WDCA-20 WUTR-20 WBP-21 WWHO-24 WSYL-25 WTFA-27 WBRB-28 WDAU-22 WTAP-29 WBNY-36 CICO32-32 WWPB-31 WOPC-38 WITR-33 WSBA-43 WICZ-40 WBJA-34 WKED-50 WPGH-53 WTVS-56 CICO59-59 WQPR-62 W63AB-63 PA WPRO-42 WUCC-44 WNSO-45 WKBS-48 W41AA-41 WV, & others"
- 14 Es "Heavy skip about 1200--channels 2-6 extreme skip--FM loaded--Kansas noted first, then Texas, Louisiana, Oklahoma, New Mexico, MEXICO. Some of best logged: XNW-2 Mexico City DF, XHTV-4 Mexico City DF, XHBO-3 Mexicali BC, KKNW-3 Portales NM, KDB-4 Albuquerque NM (all double-hop Es) and 2 high band skippers, WFAA-8 Dallas TX & KTBC-7 Austin TX. Too many others seen to list--nearly every low band sta in Texas and others."
- 15 Tr "Trops very good also that day--Binghamton, Elmira, Scranton, etc."
- 15 "From the hills--good in a.m.: WTAP-15 CHLPT5-15 WANE-15 WNDU-16 WDCA-20 WUTR-20 WSYL-25 WUHQ-41 WVIA-44 CHLPT4-44 WSKS-46 WJSJV-26 W63AB-63, WNEB translators on 72,73,76,80,81,82; all Canadian U's very good."
- Es "a.m.: WBRZ-2 KATC-3 WWL-4 WDSU-6"
- 17 "Excellent--CFAC-2 Calgary AT, CKXT-5 Edmonton AT CKRD-6 Red Deer AT, CKK-5 CBWFT-3 CBWT-6 CHSE-4 Churchill MB CKBI-5 CHSS-6 CKOS-3 (some nice single and double hops to the central and western provinces, Bob -bt) CBHT-3 CKCK-2 CHAU-5 Carleton QB"
- 20 KATC-3 WBRZ-2 KALB-5 WDSU-6 "and others--good skip"
- 21 "Very heavy skip in a.m. into early p.m., then evening again. Texas, Louisiana, Oklahoma, Kansas--some seen: KFDW-6 KALB-5 KTVI-4 KORT-2 KARD-3 WDSU-6 & many others."
- 22 "Heavy skip mid-morning to mid-afternoon--Denver chs 2-4-6, also Kansas, Wyoming, etc. Early evening skip: CKCW-2 CBHT-3 CJER-3 and others to northeast--good opening."
- 23 to 30 Es "Some skip throughout period. Some short skip to Minnesota--KDAL-3 and some double hop to Idaho, Montana and Utah...did not keep detailed loggings."
- July
- 1 to 5 Es "Heavy skip in this period especially on chs 3,4,5 including Es into Mexico again and double hop. High band skip again on channels 7 and 8."
- 13 Tr "Super tropes noted in hills. U's in from Michigan to Iowa. Some seen: WTVO-17 WCPC-38 WSNS-44 WCIU-26 KHIN-36 Red Oak IA, WFLD-32 KRIN-32 KVFD-50 Ft Dodge IA (through WKBD-50), WCAB-50 KTTN-21 Ft Dodge IA W5AK-75 Jacksonville IL, KINL-30 WICD-20 WIGS-20 WMBD-31 WENE-38 WOUB-20 WCEB-23 WJSJV-28 WNDU-16 WSBT-22 WBIT-34 WBGU-57 WLIO-35 WGYC-35 WKAR-23 & others."

Bob Seybold (continued)

July

- 14 Tr \*Trops opened up great and became super opening by evening. It had been quite good all day, then continued all night and was still strong next a.m. Some very good stuff seen and several new—huge run of translators. VHF tropes: WMAR-2 KYW-3 WOAY-4 WGAL-8 WPVI-6 WCAU-10 WDTV-5 WTWR-6 WKHX-8 WCHS-8 WSWP-9 (rare) WBOY-12 WOVK-13 WGTO-8 Detour, MI; WKXB-11 WWTW-9 WWUP-10 WZZM-13 CHLH-13 WJRT-12 CFCA-12 CJOH-13 & others. UHF: WCMU-14 WLYB-15, all Soranton-Wilkes Barre U's excellent, Philly 17, 29 & 48 good also; CHLFT5-15 CHLFT8-34 Penetanguishene ON, CHLFT4-44 CHLFT2-40 CHLFT3-48 CHLFT7-55 Barrie ON, CHLFT1-76 CHEFT-78 plus all TVO translators 18, 24, 28, 32, 59, WBRF-45 WMPB-67 WKPT-19 WENT-19 Huntsville AL, WOUB-20 WDCA-20 WUTR-20 WHP-21 WPAP-15 WAPB-22 WKPT-22 WKAR-23 WVU-24 WHAG-25 WSTA-26 WYAH-27 WKYT-27 WENB-30 W50AA-30 WAAY-31 Huntsville AL, WNYC-31 WLKY-32 WMUL-33 WFTK-33 WITF-33 WOSU-34 WLIO-35 WKHA-35 WGVC-35 WKMR-38 WOPC-38 WSHK-38 WLVT-39 WUNJ-39 Wilmington NC, WDRB-41 W41AA-41 WNEO-45 WKLE-46 WSVN-47 WKON-52 WPGH-53 WKYH-57 WBGU-57 WPBO-42 WSRA-43 WOUC-44, also WMEG-26 Biddeford ME. Translators: W50AA-50 Watertown NY W68AB-68 Ogdensburg NY (both WUTR xltrs), W55AC-55 Cohocton NY (WSKG xltr), W76AB-76 Rustburg VA (WCVB), W70AP-70 Lovington VA (WCVB), W60AN-80 Amherst VA (WERRA), W76AN-76 Cobles Creek VA (WCVW), W74AD-74 Cobles Creek VA W60AD-60 Savona NY (WSKG), W70BC-70 Harrisburg PA (WPHL), W70BA-70 Williamsport PA (WHP), W66AB-66 Mehoopany PA (WVIA), W75AC-75 PA, W72AT-72 Towanada PA (WVIA), W77AI-77 Wyalusing PA (WVIA), W73AC-73 Clarks Summit PA (WNEP), W79AC-79 Clarks Summit PA (WERR); W76AN-76 Clarks Summit PA (WVIA), plus other translators on 63, 64, 65, 66, 70, 71, 72, 73, 74, 76, 80, 81, 82, 83."
- 15 "a.m.—tropes continuing—mostly eastern U's & V's—WCDC-19 WDCA-20 WBOC-16 WYAH-27, Maryland U's, eastern PA, eastern NY, W6HT-17 WUTR-20 WETA-26 WHAG-25 & others...quite a few translators."
- 16 to 23 Tr \*Trops through entire period—mostly average with some peaks. Indiana, Michigan, Pennsylvania, NY U's, Canadians good.
- 16 to 23 Es "Some occasional skip on channels 2-4."
- 24 Tr "a.m. tropes—WANE-15 WNDU-16 WKAR-23 WUHQ-41 (very good) & others." "Totals now 754. Not included in this report is recent skip this past week. Some good stuff including CUBA, also up into northeast—Newfoundland, Maine (WCSR-6 short skip) and others. Details next report."

Bill Thompson 1907 Seneca Street Buffalo, New York 14210 (EDT)

June		14 Es	1338	WISR-3 FL	21 Es	1400	KARD-3 KS
9 Es	0000 KOTA-3 SD		1400	KFSM-5 AR		1404	KTVG-6 KS
	0015 KDLO-3 SD			KXAS-5 TX		1430	KINB-3 NE
	0159 KFRY-4 SD		1535	KYTV-3 MO		1503	KTVS-3 CO
	Pierre			KFDX-3 TX		1530	KDLO-3 SD
	0217 KJUH-4 NE			KJAC-4 TX		1830	KATC-3 LA
	Hay Springs			thru WBRN			WBRZ-2 LA
2Es	0320 KUTV-2 UT		1600	KAUZ-6 TX			thru WGR
	Salt Lake City		1659	KATC-3 LA		1913	WLBT-3 MS
Es	0346 unID-4 with		1727	KRMA-6 CO		1915	KALB-5 LA
	KGIN-11 ID slide		1729	KTVS-3 CO	22	1059	KWNB-6 NE
2Es	0358 KORK-3 NV			KINB-3 NE			KYCU-5 WY
	Las Vegas		1800	KYCU-5 WY		1129	KRMA-6 CO
Es	1229 KDLO-3 SD		1830	KSNB-4 NE			KINB-3 NE
	1253 KPLO-6 SD			thru WBRN		1229	KTVS-3 CO
	1300 KOTA-3 SD		1851	KOCO-5 OK	23	2000	KTBS-3 LA
	KFYR-5 ND		1900	KTVY-4 OK	24	1148	WEDU-3 FL
	1319 WDAY-6 ND			thru WBRN		1300	WCIX-6 FL
	Fargo		1930	KOTV-6 OK			WDDB-6 FL
	1328 KXJB-4 ND	15	0028	KOTA-3 SD		2125	unIDs 2, 3 S.
	thru WBRN		0200	KOA-4 CO	26	1859	WPBT-2 FL
	1329 CBWT-3 MB		0221	KTVS-3 CO		1931	WEAR-3 FL
	1330 CBWT-6 MB		0223	KWGN-2 CO		2130	unIDs to 6
	Winnipeg		0300	KDUR-4 NE	27	1159	WEDU-3 FL
	1357 CBWCT-5 ON	16	2024	unIDs 2 S.	28	Tr 0030	conditions vy
	Ft Frances	19	2059	KATC-3 LA			good to north
10	1830 CJAP-3 NF		2301	KFDX-3 TX		0131	CFCF-12 QB
	1900 CHHT-3 NS	20	1406	KFDX-3 TX		Es 1859	WEDU-3 FL
11	1700 KATC-3 LA		1829	WEAR-3 FL	29	2350	unIDs 2 & 3 S.
	2000 WRBC-3 TN		2107	KBTX-3 TX	30	1800	unIDs to 6
12	1800 unIDs 2-5 W.			MUF 100 MHz;		1909	KXON-5 SD
	1818 KFYR-5 ND			skip soon gone		1928	KINB-3 NE





## Bill Thompson (continued)

August		3 Es 1900	WMC-5 TN Memphis	5 Es 1930	CBNAT-1-3 NF Sole Verte
2	Es 1859	KARD-3	KS	1940	CJON-6 NF
3	1658	KATC-3	LA	1925	CJAP-3 NF
	1728	KARD-3	KS	1929	CBWT2-4 MB
	1736	WDSU-6	LA	1959	KLNB-3 NE
	1758	KOTV-6	OK		KCKT-2 KS
	1805	KALB-5	LA		thru WGR
	1859	KFSM-5	AR	2Es 0408	CFRN-3 AT Edmonton

What a season! Except for a few good days, I had considered June to be pretty dull. But July was something else altogether; more short skip than I can ever remember, and many interesting openings to the Maritime provinces--continuing right into August. I never expected to catch double-hop again this season after an all-night opening June 9, but it happened again on August 7th. It seems like the only way for me to catch 2Es is to stay up into the wee hours --but Bob Seybold lded a lot of it in the midday period this year. The tropo on August 14th & 15th was fantastic; just like the best Fall inversions.

## Paul D. Traska 64 Weaver Avenue Buffalo, New York 14206 (EDT)

June		7 Es 1730	CJCH-5 NS WCAK-3 VT Burlington	15 Tr 0210	unID-72 relaying WPHL-17 PA 0224 W72AT-72 PA 0230 W65AG-65 PA Mountaintop (WDAU-22)
14	Es 1430	KFDX-3	TX	1900	CHSJ1-6 NB Bon Accord
	1500	KXAS-5	TX	1910	CJBR-3 QB Rimouski
	1610	KJAC-4	TX	10 Tr 2345	Ft Wayne U's
			Port Arthur	12 Es 1530	unIDs on 3 S.W.
	1700	KTVS-3	CO	14 Tr 0020	WUHQ-41 MI 0021 WNDU-16 IN
	1730	KLNB-3	NE		0145 unID-18 W. 1130 WILX-10 MI
		KRMA-6	CO		WJTM-6 MI
	1900	KOTV-6	OK		WNEM-5 MI
15	0230	KDUH-4	NE	1410	WCMJ-6 MI Alpena
		KOTA-3	SD	1540	WGTO-8 MI Detour
	0259	KWGN-2	CO	1850	WPBO-42 OH
	0310	KOA-4	CO	2000	WEMB-40 IN
19	2100	KATC-3	LA	2002	WUVC-44 OH
	2325	KFDX-3	TX	2003	WTAP-15 WV
20	1406	KFDX-3	TX		WOSU-34 OH
	1800	WEAR-3	FL		WEAO-49 OH
	2130	KOTV-6	OK		2035 WSVN-47 VA
21	1100	KATC-3	LA		2050 WKPI-22 KY
	1330	KTVG-6	KS		2115 WOUB-20 OH
	1400	KARD-3	KS		2135 WMUL-33 WV
	1500	KLNB-3	NE		2235 WSWP-9 WV
	1504	KTVS-3	CO		Grandview
	1900	WLBT-3	MS	0030	WLXK-18 KY WLKY-32 KY
22	1040	KRMA-6	CO		0045 unID-56
23	2000	KTRB-3	LA		"xltr of WVLA-44"
24	1157	WEDU-3	FL		0045 unID-66
25	1100	WEDU-3	FL		"xltr of WDAU-22"
26	1930	WEAR-3	FL		0055 unID-71 CBS
27	2330	WEDU-3	FL		0058 W73AC-73 PA W64AB-64 PA W63AB-63 PA
28	Tr 0027	CBLEFB-34 ON			0100 WFMZ-69 PA
		Penetanguishene 15			0104 W66AB-66 PA
30	Es 1926	KMTV-3	NE		0105 W70BA-70 PA
					0106 W72AM-72 PA Doboistown (WTPA-27 xltr)
July					0115 WBFM-45 MD ALYH-15 PA
2	Es 1930	WEDU-3	FL		0130 unID-48 relaying WJET-24 PA
3	1200	WEDU-3	FL		
	1330	WCTV-6	GA		
	1800	KATC-3	LA		
	2130	KALB-5	LA		
4	1130	KTVS-3	CO		
		KTCU-5	WY		
	1200	KOTA-3	SD		
	1400	KFDX-3	TX		
6	1300	WEDU-3	FL		
	1400	KATC-3	LA		
7	1100	KATC-3	LA		
	1300	WRBL-3	GA		
	1700	KLNB-3	NE		
	1710	CHAU-5	QB		
		Carleton			
				August	
				1 Es 2000	KYTV-3 MO
				3	1155 WEDU-3 FL 1230 KARD-3 KS 1530 KTVS-3 CO 1900 KCMO-5 MO 1930 KIVV-5 SD Lead
				2000	KLNB-3 NE
				7 Tr 0140	CBLEFB-55 ON Bartie
				Es 0350	CBWFT-3 MB CBWCT-5 ON Ft Frances CBWT2-4 MB Iac du Bonnet
				0410	CFRN-3 AT Edmonton

Robert Goodman 2030 Haring Avenue Bronx, New York 10461

"This is my first report...I'm reporting from two locations—here, where I'm from, and Cicero, Illinois, where I am most of the time lately. At neither of these locations is my equipment anything special; in the Bronx, it's downright atrocious. There I have a limping 1965 RCA portable, with a choice of built-in rabbit ears (with a loose connection) or a fixed dipole aerial, plus a UHF loop. I'm not particularly high up at either location. In Cicero I have the cheapest model Ward Airline portable, with monopole whip and UHF loop...most of my tropo comes over Lake Michigan. In June this year the Chicago area had a week-long ozone advisory from a temperature inversion; this produced lots of tropo, but no new logs for me. Logged via tropo since May '76: Milwaukee, Grand Rapids, Battle Creek, South Bend, Indianapolis. I think I've also gotten Rockford and a downstate Illinois station, but have no log. In the Bronx over several years—including lately: WEDH-24 & WHNB-30 CT; WWLP-22 MA; WJAR-10 & WPRI-12 RI; WPHL-17 PA; WBAL-11 MD. Plus probably some others, no log. The 7/16 tropo accompanied severe air pollution over Connecticut, and produced my first Massachusetts log. NYC blackout might have provided DX opportunity, but no battery set!"

(At Cicero IL:)

June (CDT)  
 6 Es 1700 unID-3 CANADA  
 8 1030 unID-3  
 14 1930 unID-3  
 20 2000 KATC-3 LA  
 Lafayette  
 "ID by Mike Hogan"  
 21 1900 WWSN-2 FL  
 Daytona Beach  
 "thru a local"  
 1900 WJXT-4 FL  
 Jacksonville

(At Bronx NY:)

June (EDT)  
 24 Es 1200 WSAV-3 GA  
 Savannah  
 WHAR-3 FL  
 Pensacola  
 27 1200 unID-3  
 July  
 16 Tr 2330 WHEB-30 CT 80  
 2345 WHEB-24 CT 90  
 WWLP-22 MA 110  
 August  
 2 Tr 2300 WHNB-30 CT 80

2 Tr 2330 WATR-20 CT 70  
 Waterbury  
 3 0100 WPRI-12 RI 150  
 0200 WJAR-10 RI 150  
 0430 WCAU-10 PA  
 Philadelphia 100  
 1030 WTVV-6 MA 160  
 New Bedford  
 Es 1045 unIDs on 3  
 1800 WRDU-3 FL  
 Tampa  
 1900 KTVV-3 MO  
 to Springfield  
 2030 WRDU-3 FL

"A tropo bending condition, probably associated with an area temperature inversion, opened up starting late Tuesday night, 8/2. The opening improved over the early morning hours, with distances increasing and frequencies decreasing. Tropo ended late Wednesday morning, 8/3, with rain following locally. Meanwhile sporadic E skip came in for the rest of the day. Not many IDs from this very crowded, fadey Es, but lots of grist for Frank Aden's CGI mill."

Bob Zent 1835 Fruit Street Huntington, Indiana 46750 (EST)

June  
 10 Tr 2125 WKGB-53 KY 275  
 WBBT-25 IN 230  
 WFLB-14 IN 230  
 14 Es 1530 WBRZ-2 LA 800  
 KATC-3 LA 840  
 1630 KTFW-2 WY 1110  
 1634 KOTA-3 SD 975  
 1640 KDLX-2 ND 1000  
 1900 KTRB-3 LA  
 Shreveport 750  
 26 Tr 0015 WAND-17 IL 200  
 WRAU-19 IL 220  
 WRRK-25 IL 220  
 WICS-20 IL 240  
 0030 WCRB-23 IL 215  
 WTVO-17 IL 215  
 WKOW-27 WI 255  
 0050 KINI-30 MO 305  
 0750 WPGH-53 PA 290  
 0755 WPMJ-21 OH 250  
 WKCN-27 OH 250  
 WTTV-33 OH 250  
 WVIZ-25 OH 200  
 WAKR-23 OH 205  
 26 Tr 0800 WJAN-17 OH 210  
 July  
 1 Tr 0630 WBBT-25 IN 230  
 WKPC-15 KY  
 "quite strong thru  
 local WANE-15"  
 2 0700 CICO-18 ON 260  
 CKGN-22 OH  
 CKGN-29 ON 200  
 CKCO-42 ON 200  
 CBLFT2-40 ON 260  
 CBLFT3-48 ON 200  
 CICO-59 ON 200  
 0725 WKYH-57 KY 290  
 Lexington U's  
 0740 WRAU-19 IL 220  
 WRRK-25 IL 220  
 WMBD-31 IL 220  
 WNEO-45 OH 220  
 WBAO-49 OH 205  
 WAKR-23 OH 205  
 WVIZ-25 OH 200  
 Youngstown U's  
 0750 W6BAA-68 IL 125  
 3 0730 CICO-59 ON 200  
 3 Tr 0730 CBLFT3-48 ON 200  
 CBLFT2-40 ON 260  
 CICO-18 ON 260  
 CKCO-42 ON 200  
 CKGN-29 ON 200  
 CBLFT1-76 ON 300  
 CICO-28 ON 300  
 CKGN-22 ON  
 0745 WPGH-53 PA 290  
 WJBT-24 PA 290  
 WSEB-35 PA 290  
 Youngstown U's  
 0750 WKZT-23 KY 240  
 Lexington U's  
 0810 CBLFT-25 ON 360  
 WNEO-17 NY 370  
 WUTV-29 NY 370  
 Es 1900 WFBT-2 FL 1105  
 2000 WTVJ-4 FL 1105  
 "unIDs on 3&5"  
 2030 KPRC-2 TX 970  
 WBRZ-2 LA 800

Note to EASTERN TV-DX Reporters: When you send in a list of your loggings to any DX column editor, it's best to try to separate your comments from the loggings themselves. This makes it much easier for your editor to scan the report before he types it up. Any pertinent and interesting comment can be printed at the beginning or end of a report, thus reducing what some readers consider to be "clutter" in the VUD.



# MAJOR MARKET VACANT TV CHANNELS

Mike Dornier, Jr.  
1409 Hymelia Av.  
Metairie LA 70003

In view of the fact that the FCC has been considering decreasing the number of UHF TV channels, the following study should be of interest. \*: channel reserved for educational television by the FCC. @: application pending. Channels with construction permits are omitted from this listing, which covers the first 63 markets and is correct to May, 1977. -md.

RANK	MARKET	VACANT CHANNELS			
1	NY New York-Riverhead				55
2	CA Los Angeles-Orange County				*68
3	IL-IN Chicago-Elgin-Gary				56 66
4	PA Philadelphia			*35	@57
5	CA San Francisco-San Jose-Vallejo-Concord-San Mateo		@42		48 66
6	MA Boston				
7	MI Detroit				
8	DC-VA-MD Washington-Fredericksburg-Hagerstown	@14	*53	@66	69
9	OH Cleveland				19 61
10	TX Dallas-Fort Worth		@21	@27	@33
11	PA Pittsburgh				
12	TX Houston-Rosenberg	*14	@20		45 49
13	MN Minneapolis-St. Paul			@29	
14	FL Miami		@33		39
15	MO-IL St. Louis-E. St. Louis-Edwardsville	*18	@24	@*40	
16	GA Atlanta		@*57		69
17	FL Tampa-St. Petersburg		22	28	38
18	WA Seattle-Tacoma	20	@22	*28	*56
19	IN Indianapolis-Bloomington		59	63	*69
20	MD Baltimore-Annapolis		@24	@54	
21	WI Milwaukee				30
22	CT Hartford-New Haven				61
23	CO Denver-Boulder	@*12	14	@20	@31 *41
24	CA Sacramento-Stockton				64
25	OR Portland				24 30
26	MO Kansas City		@62	*68	
27	OH-KY Cincinnati-Portsmouth-Covington		30	36	64
28	NY Buffalo		*23		49
29	CA San Diego				
30	RI Providence				64
31	TN Nashville			30	*42
32	AZ Phoenix-Mesa		@33	*39	
33	NC Charlotte				
34	OH Columbus		@28	*57	
35	TN Memphis		*14	@24	
36	SC-NC Spartanburg-Greenville-Asheville			49	62
37	OK Oklahoma City		@14	@34	@43
38	LA New Orleans		20	*32	38
39	KY Louisville				21
40	FL Orlando-Daytona Beach				26
41	MI Grand Rapids-Kalamazoo			17	*52
42	NY Albany-Schenectady-Troy		23	*29	45
43	TX San Antonio			*23	29
44	WV Charleston-Huntington-Ashland		23	29	*49 61
45	PA Harrisburg-York-Lancaster-Lebanon				59
46	OH Dayton				*45
47	NC Raleigh-Durham			22	*34
48	VA Norfolk-Portsmouth-Newport News-Hampton		@33	49	*55
49	PA Wilkes Barre-Scranton			38	64
50	AL Birmingham		@21	*62	68
51	NY Syracuse-Elmira			43	62
52	MI Flint-Saginaw-Bay City	@28	45	61	66
53	UT Salt Lake City		14	20	*26
54	NC Greensboro-Winston Salem-High Point	*32	@45	48	61
55	KS Wichita-R Hutchinson	*15	24	33	36 *42
56	OK Tulsa		23	29	*35 41
57	OH Toledo				54 60
58	TX-LA Texarkana-Shreveport		17	33	34
59	AR Little Rock				16 29
60	VA Richmond				35 63
61	TN Knoxville			*15	43
62	IA Des Moines		17	25	*34 *43 63 69
63	FL-AL Pensacola-Mobile		15	21	*31 33 44

# QSL CORNER

Thomas J. Vingling, jr.  
221 Pinewood Road  
Baltimore, MD 21222  
Phone 1-301-282-5649  
Deadline: 10th

- AK KFAR 2 Fairbanks, P.O. Box 910, 99707. Send qsl-card with tv filled for a most unusual report. I don't report for qsl's, but in this case I could not resist. (either could I John, ed.) Signed by Don Garrett, CE. Anderson
- FL WPBT 2 Miami, P.O. Box 610001, 33161. Letter from Stephen L. Rogers, VP of Eng & Planning in 18 days. Samford
- WTVJ 4 Miami, 316 N. Miami Ave, 33128. Friendly letter & coverage-map from Kenneth S. Littrell, Manager of Tech Oper. in 10 days. Samford
- WJXT 4 Jacksonville, P.O.Box 5270, 32207. Letter & technical data from King Harrison, Eng. Manager in 1 week. "...always glad to receive reception reports. Goodman
- WESH 2 Daytona Beach, Box 1551, 32015. Card in 1 week from Mac Gagle, CE. Goodman
- IL WCIU 26 Chicago, (no address given) reception verified with note written on original letter, signed by R. L. Ashefelter in 17 days. Walker
- MO KOTV 2 St. Joseph, P.O. Box 247, 64506. QSL-Card in 15 days unsigned. Walker
- MS WAPT 16 Jackson, P.O.Box 10297, 39209. Very friendly hand-written letter from Fred McRae ? (no title given) in 5 days. Samford
- OK KOCO 5 Oklahoma City, P.O. Box 32325, 73132. Letter from Mike Palmen, VP of Broadcast Operations. Cottan
- PA WTAF 29 Philadelphia, 4th & Market Sts., 19106. QSL-Card for 29, signed by Robert N. Owens, CE. Cottan
- SC WCBD 2 Charleston, P.O. Box 879, 29402. Form letter from Walter M. Nelson, Dir of Eng. in 9 days with reception date left blank. Samford
- TX KSAT 12 San Antonio, Box 2478, 78298. Letter in 1 week & kept SASE send on second try. Signed by David Carr, CE. Glasgow
- UT KUTV 2 Salt Lake City, 179 Social Hall Ave, 84111. Letter send from Reid Carpenter, DE in 6 days for my double-hop-E-skip. (nice, ed.) Traska

## PSB-QSL

- PA KGC-400 35.22 Scranton, Radio Paging of Northeastern PA, 301 Cedar Ave. 18505. Send back prepared card, 500 watts, voice-id unreadable signer. Santosuosso
- KGC-397 35.22 Wilkes-Barre, Radio Paging of Northeastern PA, 134 S. Main St. 18701. Same as above, qsl with prepared card & verie signer was the Vice-President-Manager, but unreadable. Santosuosso
- OH KQK-593 35.58 Cleveland, Digital Paging Systems of Cleveland, Inc., 1367 E. 6th St., 44114. Prepared card, no signer for code id report. Santosuosso

## FM-QSL

- ON CKNX 101.7 Wingham, 215 Carling Terrace, N0G 2W0. Letter in reply to report & my air check. "...I was thrilled to learn of the quality & strength of our signal in your city of Brantford." Signed by Gary Moon, Program Co-ordinator. Reply in 2 weeks. Ellis
- AL WIRB 96.9 Enterprise, P.O. Box 1136, 36330. Letter & sticker from Larry Searcy, CE "It was quite an honor to know that you received out signal about 890 miles away...Yours is the first from Canada." Sawatzky
- AR KKYK 103.7 Little Rock, 1001 Spring St., 72202. Letter & card from Jeffery Gulick, CE WBSW-RX in 3 months. He urged me to become a ham, which ironically I had done just before I got the letter. Sawatzky
- MN KLOH 98.7 Pipestone, Box 512, 56164. Letter signed by Wallace Christensen in 10 days for reply. Glad to hear there station is getting out here. West

Reporters are: John F. Anderson of Lowe Farm, Man, Canada; my most northern reporter, Rick Samford of Burnet, TX, Robert Goodman of Bronx, NY, Robert C. Walker of Westport, KY, Edward R. Cottan of Chesapeake, VA, Rick Glasgow of Ackerman, MS, Paul Traska of Buffalo, NY, Albert H. Ellis of Brantford, ONT, & Peter Sawatzky of Waterloo, ONT & Steve West of Havertown, PA. My thanks to all my reporters. I'm so happy that the column is now going strong again. I got so many new reporters! I got another new PSB-QSL reporter of John Santosuosso of Lakeland, FL. John Anderson of Lowe Farm reports the first QSL from Alaska that anybody has ever reported to this column that I know of. Now, just because I got alot of reports, please don't stop. Keep it up and support your club QSL-Corner, and show off that prize qsl that we all like. 73's

*Tom*



# C.C.I. [UNIDENTIFIED DX]

Frank Aden, Jr.  
1535 NW Ithaca  
Bend OR 97701  
(503) 389-5488  
Deadline: 10th

SEPTEMBER 1977 SOURCE FOR PR TELE GUIA FOUND!

Ken Simon reports that Franco Communications, Inc., 41-11 150 St., Flushing, NY 11353 can supply copies of the Puerto Rico "TELE GUIA". I have not yet had time to buy some copies from the above but will report on results when in.

A source is still needed for the Mexican "Tele Guia".

The San Francisco office of TV GUIDE reports the Eureka and Redding stations are in the Northern California Edition.

## Unidentified TV DX

Frank Wheeler, 6589 Wattsburg Rd., Erie PA 16509 (1977 unIDs)

Sat Jul 2 Es ch 2 1900 EDT-- "WMTS Austin City, Channel 2" FL stations in at the time. (There are many Austins in the US but no Austin Citys listed. Could this be a new station? ---FEA.)

Paul Traska, 64 Weaver Ave., Buffalo NY 14206 (1977 unIDs)

Fri Jul 15 Tr ch 56 0045 EST-- W56?? xltr of WVIA-44. Must be a new one but what is location?

ch 66 0056 EST-- W66?? xltr of WDAU-22. Information like above.

ch 71 4058 EST-- W71?? xltr of CBS programing, probably WDAU-22.

Location NE/PA.

ch 48 0130 EST-- Xltr of WJET-24, do they have a new xltr?

ch 72 0210 EST-- Xltr of WPHL-17, location Harrisburg area. Seen after W72AM Duboistown s/off.

Wed Jul 20 Tr ch 4 0220 EST-- Talk show or news, too weak to tell. Location east, tent. WBZ. (WBX has "Tomorrow" at 0000 and "news" at 0100. ---FEA.)

Thomas J. Yingling, Jr., 221 Pinewood Rd., Baltimore MD 21222 (1977 unIDs)

Mon Jun 6 Es ch 6 1721 EDT-- "Diana Shore" PTA: ND, SD, MAN. (WOWT checks. ---A.)

ch 5 1752 EDT-- "Flintstones" PTA: As above. (TV GUIDES no help. ---FEA.)

ch 3 1922 EDT-- "Gomer Pyle" PTA: As above. (TV GUIDES again no help. ---FEA.)

ch 6 1933 EDT-- "Get Smart" PTA: As above. (Same as above. ---FEA.)

ch 3 1939 EDT-- "Name that Tune" PTA: Same as above, (KGLO checks. ---FEA.)

ch 4 1941 EDT-- "Hee Haw" PTA: As Above. (KXJB checks. ---FEA.)

Tue Jun 12 Es ch 4 ??? EDT-- PBS station with program produced by Maine PTVN. (This might be WUNC as MPTVN is a member of the Eastern Ed. TV Network as with WUNC. ---FEA.)

Sun Jun 24 Es ch 3 1914 EDT-- "Hee Haw". Cuba in on 3 & 6. WLBT? KATC? (All TV GUIDES for deep south are negative. ---FEA.)

## Unidentified FM DX

Frank Wheeler, address above (1977 unIDs)

Fri Jul 15 Es 107.9 1000 EDT-- "CINB, Burlington, 107.9" New station?

Thomas Yingling, address above (1977 unIDs)

Sun Jun 24 Es 94.3 1850 EDT-- ID for KMIX with ad for "Jarnells".

96.7 1854 EDT-- Call letters KIMP heard with C & W music and contest to ID the Mystery Country Loving Person. Gave GDT time check.

John Ebeling, 9209 Vincent Ave. S., Bloomington MN 55431 (1977 unIDs)

Sat Jun 9 Es 92.4 1620 CST-- "music, written by Dr. Herb Wald... music up in the Frisco area... Dr. Hedley Tripps hair cutting, 2620 West Butler Dr... Telephone info service negative for San Francisco and Los Angeles. Stations in for CO, AZ, WY and MT. (There is a Frisco in CO, maybe KGRE. ---FEA)

(continued on page 51)





# VHF UTILITY DX

Pat Dyer  
5315 Silvertip Drive  
San Antonio, TX 78228  
Deadline: 10th of month

SEPTEMBER 1977

Hank Holbrook, 7211 Chestnut St., Chevy Chase, MD 20015 QSLed, GMT

<u>12-18:</u>	1530, N1924V	133.5	vic DC (Genesco, Inc.; Falcon 10, 2-e, 7-s)
<u>4-16:</u>	2028, N7696J	119.7	ov Annapolis (Mitchell & Collins, Inc.; Piper Cherokee Arrow PA-180R, 1-e, 4-s)
	2130, N34843	119.7	2 mi n Annap. (Blue Jay Flying Club; Cessna C-177; 1-engine, 4-seat)
	2229, N8426R	119.7	ov Ches. Bay Br. (Lloyd D. Kauffman, Jr.; Piper Cherokee 140; 1-engine, 2-seat)
	2306, N581PH	119.7	vic Balt. (Michael R. Nash; Fairchild FH 1100 helicopter; 1-engine, 4-seat)
<u>5-7:</u>	0130, K1H 28	162.475	Philadelphia, PA (NOAA Weather Radio; 1 kw, 8-bay dipole about 550 feet ASL)
	1922, N4554T	118.1	10 mi s Annap. (Robert A. Ross; Piper Cherokee 180G, 1-engine, 4-seat)

Martin J. Theil, 12 Princeton Drive East, Holiday, FL 33589 with a new Bearcat 210 scanner, rod antenna

35.66	New York (mobile phone)	37.575	Tampa (power)
35.26	Detroit ("")	153.620	FL (power)
35.26	Philadelphia ("")	156.21	Cape May, NJ (police)
35.26	Cleveland ("")	38.75	Iowa (wx)

KKC 374	37.26	OK Co, OK	KSB 234	39.46	IL (police)
KEE 720	33.78	Millburn, NJ	KSA 358	39.46	Yorkville, IL (police)

My loggings, Allied A-2586 w 30' wire at 12' (nw-se run); VOR's on Heath GR-98 with 6-el FM antenna at 20 feet; all Es unless noted; new; GMT

<u>7-23:</u>	1853, KFL 936	35.58	(west) (tone pager)
<u>26:</u>	0645, KKI 445	35.58	Houston, TX (tone pager) (tropo)
<u>29:</u>	0225, KOA 796	35.58	Portland, OR (tone pager) (2Es)
	2255, "ELW"	108.6	Electric City, SC (VOR, tone/voice)
	2315, "PBG"	109.8	Simmons, NC (VOR, tone)
	2332, "SOT"	108.8	Snowbird, TN (VOR, tone/voice)
	2347, "CLT"	110.6	Charlotte, NC (VOR, tone)
<u>8-5:</u>	1548, KOE 257	35.22	Phoenix, AZ (tone pager)
<u>6:</u>	1932	30.30	(F2)

Though I've managed to log several VOR's this season on Es, it was far from the simple task I'd expected it to be (e.g., easy-to-read Morse tone ID's every 10-15 seconds). Fading on these is usually rapid and that chops the ID to shreds very often. Most seem to have very poor modulation percentages to begin with.

August QST has some of the details of the 50-MHz California-Japan Es opening of June 4. Later issues should fill in more on events that took place later in June and into July. Even into late July the Guam to Japan and to Alaska paths were often open on 6-m.

Solar fluxes are running above last year at this time, so the prospects for something of a fall F2 season in 30-50 MHz appear good, though it may take some magnetic disturbances to really get the MUF's up much. We'll know a lot more about that in about 2 months or so. There may be some slim chances to Es-TE links in Sep-Oct for the southern US.

73, Pat WA5IYX

# Memorabilia



Robert J. Williams  
251 6th Avenue East  
Twin Falls, Idaho 83301  
Phone: (208) 733-3621  
Deadline: 10th of month

September 1977

## THE OLD "CONCERT NETWORK"

This month, MEMORABILIA remembers the FM "Concert Network" of the 1950s. This network of four FM stations served New York City and vicinity (including parts of New Jersey and the very eastern end of Pennsylvania), and parts of New England. The stations comprising this network were WNCN-104.1 Boston MA, WXCN-101.5 North Foster RI, WCHN-106.9 Meriden CT, and WNCN-104.3 New York City NY. The original station was probably WTMH (FM) in Providence RI. The Concert Network was run by T. M. Hastings.

Thanks to Richard J. Steinberger of Hudson MA for supplying the above information and the coverage map (below).

## CONCERT NETWORK LISTENERS ARE BOTH LOYAL AND WIDESPREAD

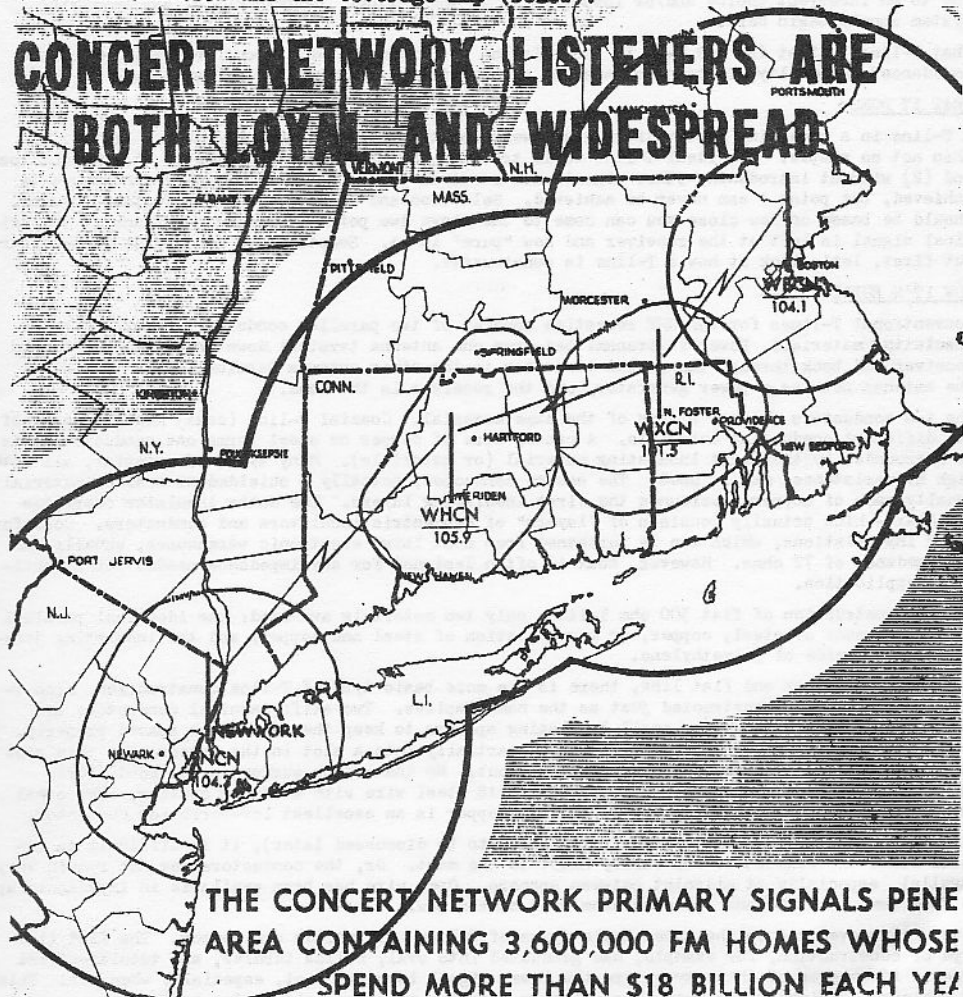

THE CONCERT NETWORK PRIMARY SIGNALS PENE-  
RATE AN AREA CONTAINING 3,600,000 FM HOMES WHOSE  
SPEND MORE THAN \$18 BILLION EACH YEAR

Keep the memories coming, fellas. 73s, gud DX, *Bob*

# TECHNI-

# CORNER

conducted  
by  
Dave Janowiak

## ALL ABOUT TRANSMISSION LINES

Unquestionably, the transmission line (T-line) is the most misunderstood and misused component in the average DXer's receiving set-up. When upgrading an existing receiving system—or installing an entirely new system—most attention is given to high-gain antennas, tall masts, boosters, etc. The poor neglected T-line is usually taken for granted.

But one fact cannot be ignored: As much as 50% of the useable signal at the antenna may be lost due to an incorrect choice and/or installation of the T-line. Improvement of any receiving system should begin here.

What T-line is best for me? Why is installation so critical? What about velocity factor and impedance? Hopefully, these questions and others will be answered in this article.

## WHAT IT DOES

A T-line in a receiving system transfers power from the antenna to the receiver. Simple, but then not so simple. The ideal T-line would transfer this power to the receiver (1) without loss and (2) without introducing other signals not received by the antenna. Point 2 can almost be achieved, but point 1 can never be achieved. Selection and installation of a T-line, however, should be based on how close you can come to the above two points; that is, how much of the original signal is left at the receiver and how "pure" it is. Sometimes, a compromise is necessary. But first, let's look at how a T-line is constructed.

## HOW IT'S BUILT

Conventional T-lines for VHF/UHF reception consist of two parallel conductors separated by an insulating material. Power is transmitted from one antenna terminal down one conductor to the receiver and back through the second conductor to the other antenna terminal. (In this case, the antenna acts as a power generator, and the receiver is the load.)

The two conductors are not always of the same material. Coaxial T-line (coax) might consist of two different conducting materials. A center wire of copper or steel forms one conductor; this is surrounded by the first insulating material (or materials). Many types of material, all with high RF resistance, may be used. The second conductor, actually a shielded or braided material usually made of copper, surrounds the first insulating layers. The outer insulator completes the coax—which actually consists of "layers" of concentric insulators and conductors. Coax for TV-FM installations, which can be purchased from most large electronic warehouses, usually has an impedance of 72 ohms. However, coax is often designed for any impedance needed for a particular application.

In the construction of flat 300 ohm T-line, only two materials are used: the identical parallel conductors made of steel, copper, or a combination of steel and copper; and the insulating jackets, usually made of polyethylene.

In addition to coax and flat line, there is one more basic type of T-line construction: open T-line. This type is constructed just as the name implies. Two stiff parallel conductors are supported every six inches by small insulating spacers to keep the conductors spaced properly. During manufacture, each conductor is forced partially into a slot in the spacer, and this slot is forced closed so the conductor cannot pull out. No insulation surrounds the conductors. These conductors are copperweld wire: usually #18 steel wire with a copper coating. The steel provides tremendous tensile strength, and the copper is an excellent low-corrosion conductor.

While this type of line has extremely low loss (to be discussed later), it is difficult to install since the conductors can easily short to the mast. Or, the conductors may not remain very parallel, especially at midpoint between spacers. Open wire has been available in impedances up to 1000 ohms, but 300 and 450 ohms seem most common now.

Several improvements in the three basic types of T-line and hybrids are common. The flat line type of construction, for example, has graduated into oval, hollow tubular, and tubular-filled types. Advantages of these types are the lower signal loss per foot, especially when wet. This is achieved, basically, by providing a longer path for moisture, either due to the larger circular route moisture must take to get to the conductors or due to a thicker insulating web. (While the dry loss per foot of round types of T-line may be no better than that of a good grade flat line, the loss when wet of round types may only approach 50%, but wet loss of flat line approaches 90 to 95%.) Some types of tubular T-line have a foam center for improved performance when wet.



The most popular hybrid is the shielded 300-ohm line recommended for color TV. While construction varies, this type resembles the basic flat type, but several layers of insulator as well as an aluminum shield surround it, with conventional polyethylene insulator holding this "sandwich" in place. The shield, although increasing the loss per foot slightly when compared with other tubular T-line, improves reception by reducing the effects of metal gutters or masts. Also, man-made noise (ignition, etc.) is reduced, and the T-line does not serve as an antenna itself (a problem that could destroy a color picture).

### T-LINE CHARACTERISTICS

Of the many characteristics associated with T-lines, only some characteristics are important to DXers. Data may be obtained in catalogs or from local TV shops, but usually not enough is provided for a thorough evaluation; a letter to the manufacturer is needed for complete data. Let's look at these important characteristics.

#### LOSS

The loss (attenuation) characteristic reveals the power lost between antenna and receiver in the T-line per distance at a given frequency under ideal conditions. Power loss is usually given in decibels (dB) for a 100-foot line at specified frequencies. Typically, loss for 300-ohm open line is given as 0.5 dB for 100 feet at 200 MHz. (Catalog statistics can be vague, however. The same 300-ohm line is given a 1.9 dB loss over the "entire" UHF band in one catalog. This is, of course, impossible; line loss always increases with frequency. The stated 1.9 dB loss probably is for the low end of the UHF band.)

For those not familiar with power losses expressed in dB, the following table is given:

<u>dB LOSS</u>	<u>% OF POWER LEFT</u>	<u>dB LOSS</u>	<u>% OF POWER LEFT</u>	<u>dB LOSS</u>	<u>% OF POWER LEFT</u>
0.5	89%	2.0	63%	5.0	32%
1.0	80%	3.0	50%	7.0	20%
1.5	70%	4.0	40%	10.0	10%

Losses are given under ideal, dry conditions. Since moisture increases losses, a more meaningful figure is the line loss when wet as well as dry. Manufacturers should supply this figure. "Low loss" lines usually mean low loss when wet. For example, good round T-line might have as much loss as cheap flat line when dry at a low frequency. But the loss for flat line might increase by 20 times when wet, especially at the high frequencies.

Since you, the customer, don't know if the wet loss is for a "damp" line or for a line totally immersed in water, even these characteristics can be misleading. But, the dry and wet loss is the most important characteristic when selecting a T-line. Later on, in discussing the selection of a T-line for DX, I'll list typical loss figures for popular lines.

#### IMPEDANCE

Maximum power is transferred from antenna to receiver if impedances are matched. Usually, a 300 ohm line matches a 300 ohm antenna and receiver. But pre-1950 TV sets and some recent color TV sets have 72 ohm input terminals also. A 72 ohm antenna can be connected directly to this input with 72 ohm coax. Some antennae have a built in matching transformer (balun) for converting the 300-ohm antenna to a 72 ohm T-line. The balun is discarded if 300 ohm line is used. However, the customer usually must purchase a balun whenever matching a 72 ohm line to a 300 ohm device. Some loss always occurs due to baluns. For DXers, the 300 ohm antenna, receiver, and T-line are best under normal conditions.

#### INSULATORS AND CONDUCTORS

Except for coax and open T-line, stranded steel (or copper and steel) wire form the conductors. More wires in a given strand increase strength (wire size being the same). Low cost T-line may use only four strands; these could weaken and break in a wind. Web thickness indicates strength and possible resistance to moisture; not only is T-line with a thicker web stronger, but its wet loss per foot will be less due to the greater distance from the conductor to the outer surface. Polyethylene is the most common insulator. Cheap flat line—which may have a clear, cheaper type of insulator—can be used, but indoors only. However, it may soon become brittle or crack.

#### NOISE

Open wire picks up man-made noise (power mower, shaver, neon lights) more than others, for obvious reasons. Coax or shielded 300 ohm line pick up the least. Noise effects will be discussed later on in this feature.

#### COST

Like many items, you usually get what you pay for. Spare no cost in selecting a T-line. This is only a small part of the total antenna/receiver cost, so don't cut corners here. (I've known a few people who spent \$50 and up for stacking a second antenna, but never realized the 50% power gain increase because they installed cheap flat line in place of a better grade original T-line!)

The very best T-line is still inexpensive compared to the investment in DX antennas, receivers, preamps, etc. Since the proper T-line is crucial to your DX receiving system, be sure you don't overlook its quality.

With few exceptions, only the lowest loss T-lines should be used for DX. Rather than note the best and add the "ifs" and "buts," I'll comment on each individually. The type, typical loss, noise pickup, and installation are noted for each. The dry and wet losses are approximate and expressed in dB per 100 feet.

**FLAT LINE:** If only one idea is remembered from this article, make it this: Never use flat T-line outdoors for DXing. The loss of flat line, quite high at high frequencies, jumps tremendously at all frequencies when wet. For example, only 1/3 of power is left at ch 19 with wet flat line! dB Loss: 100 MHz: dry 1.2, wet 7.3. 500 MHz: dry 3.2, wet 20. 1000 MHz: dry 5.0, wet 30.

**Noise Pickup:** Moderate, usually no problem except close to neon signs or machinery. Like all T-lines, except 300 ohm shielded and coax, flat line will serve as an antenna (especially if run horizontal and broadside to transmitter). This will cause some phase shift and degradation of color TV or multiplex FM signals.

**Installation:** Very easy. However, line deteriorates after a few years and must be replaced.

**OPEN LINE:** Lowest loss of all. This is the ideal T-line to use if loss only is considered, if carefully installed, and when man-made noise is no problem. Especially good at UHF or where long runs are required.

**dB Loss:** 100 MHz: dry 0.5, wet 1.0. 500 MHz: dry 1.9, wet 4. 1000 MHz: dry 4, wet 8.

**Noise Pickup:** Slightly more than flat. Might be a problem for color, but not black and white. (Power mowers, shavers, etc. have been operated within 10 feet of my open wire with no effect on picture with 1965 Zenith b&w TV set.)

**Installation:** Difficult. Mast standoffs are hard to come by. I used a good grade round T-line from antenna to roof, then open wire supported by "nail-type" roof standoffs for open wire. In contaminated areas, open line might have to be replaced in two or three years.

**ROUND LINE:** In this general class are tubular, tubular filled, oval, etc. If open line cannot be used, this is usually the next best choice; it is the most popular type used for DX.

**dB Loss:** 100 MHz: dry 1.1, wet 2.5. 500 MHz: dry 3.0, wet 6.8. 1000 MHz: dry 6.0, wet 12.0.

**Noise Pickup:** Slightly less than flat.

**Installation:** Fair. Hard to fit through some standoffs and hard to attach to some antennas. Has longer life than previous two types.

**300 OHM SHIELDED LINE:** This is the best for color. It's a compromise between fairly low loss (more than round line but much less than coax) and immunity to man-made noise. The shield also reduces signal pickup due to the line itself, which could subtract from the principal signal. It's probably a good choice if a color set is used for family viewing as well as DXing.

**dB Loss:** About 20% greater than round; approximate typical loss figures not at hand.

**Noise Pickup:** Very little, its greatest advantage.

**Installation:** Fair. Easy to run, but difficult to strip, feed through standoffs, and attach to some antenna terminals. Should last longer than previous types.

**72 OHM COAX:** Loss is the greatest by far with coax, although moisture has almost no effect. At UHF, dry loss is too high for serious DXing. The main advantage of shielding can be duplicated with 300 ohm shielded line, without sacrificing gain and buying baluns. However, this type is OK at VHF if (a) length is 50 feet or less, (b) noise is extreme, and/or (c) line must be routed through or over metal.

**dB Loss:** For the RG-59U type, dry loss is 3.7 dB at 100 MHz, 9.6 dB at 500 MHz, and 14.5 dB at 1000 MHz. For RG-11U (not offered in many catalogs), dry loss is about half that of RG-59U. In foreign countries, lower loss coax is available and is used almost exclusively.

**Noise Pickup:** With 300 ohm shielded, lowest of all.

**Installation:** Very easy. Should last two or three times as long as previous types.

From the above, it is obvious that each DXer must evaluate his own setup. If lowest noise is mandatory, select open line, install it very carefully, but be prepared to replace it in a few years. At the other end of the line, coax lasts the longest, costs the most, is the easiest to install, but has the highest loss. Never use coax for UHF. Shielded type compromises, with emphasis on reduction of noise and ease of installation. Round type compromises also, but lower loss is emphasized.

#### INSTALLATION OF T-LINE

Merely choosing the ideal T-line for your particular case will not guarantee best performance. The line must be installed correctly.

Shielded T-line allows a "sloppy" installation. The line can lie on or near metal, or it can be routed broadside to a power generating device with no effect. The only rule is to make line length as short as possible due to the higher loss per foot.

Installation of other types of line is more critical. This last section will outline basic rules that govern conventional installations: 300 ohm line to 300 ohm devices. No attempt is made to describe the use of various connectors or baluns or how to correctly ground the T-line.

Three basic rules for conventional 300 ohm lines must be followed: (a) keep it short, (b) avoid horizontal runs, and (c) keep it away from both insulating and non-insulating surfaces. Note that most of the rules on the next page are simply extensions of these three basic T-line rules for conventional systems. To maximize the performance of the T-line you choose, be certain to observe these guidelines.



## TECHNI-CORNER

- 1) Plan the best route before purchase, using the rules noted below. T-lines usually come in discrete lengths (50, 100, 250 feet), so planning beforehand to determine approximate length can save money. Usually, choose the most direct route, considering antenna height, best entry into house, location (present or future) of receiver, etc. However, avoid long horizontal runs that place the line broadside to strong local transmitters or within five feet of AC power lines, even if doing so increases line length.
- 2) Attach line tightly to antenna or preamp terminals. Preferably, crimp or solder a closed eyehook connector to each conductor; this will simplify installation and strengthen these connections. Or, twist strands together, tin with a soldering iron, and form a loop to simplify the attachment.
- 3) When attaching T-lines other than the flat type to no-strip terminals with serrated washers that are supposed to pierce the insulation, exercise special care. Since it is almost impossible to pierce the insulation enough to make good contact with the conductor, either (1) cut off enough conductor from the end of the line to form a thin section resembling flat line, and insert and tighten under the no-strip washers, or (2) discard the serrated washers and attach as in rule 2 above.
- 4) If a strain relief is not supplied on the antenna boom, mount a mast standoff near the terminals. Always use the longest mast or roof standoffs available; those with an insulating eyelet are best. (The other type—with metal loop that surrounds the line—can attenuate signals.) Most standoffs accept all types of T-line.
- 5) If tubular hollow line (no longer popular) is used, insert a plug into the end to prevent any moisture from entering.
- 6) Use mast standoffs only as often as necessary to prevent contact with guy wires, mast, boom, etc. Do not force T-line so hard into the eyelet that the conductor spacing, and impedance, is altered. Conversely, if T-line fits loosely through the eyelet, wrap a few turns of waterproof tape around the T-line on both sides of the standoff to prevent slippage.
- 7) Twist T-line about one turn for every five foot length to reduce electromagnetic pickup. But be careful that open wire doesn't "flip" over and short out!
- 8) On multi-antenna masts (not recommended for DXing, but usually a necessity due to economics), use waterproof tape to hold T-line from upper antenna several inches away from the elements on the lower antenna. Arrange mast standoffs 180° away from each other to reduce coupling.
- 9) Allow enough loop or slack for rotation. Usually, the rotor control and antenna are pointed south initially so that an equal minimum of slack allows rotation in either direction.
- 10) Keep T-line as far as possible from rotor cable. Dual standoffs allow about 5" separation.
- 11) Avoid T-line bends greater than 90° between antenna and receiver.
- 12) Use roof standoffs sparingly, but keep T-line away from gutters, flashing, etc. Make sure the T-line cannot pull through the eyelet and touch metal by taping as in rule 6. Screw roof standoffs in far enough for strength. (Tar can always be used to prevent a leaky roof.) Roof standoffs that just pierce the shingle may bend due to strong wind and/or iced T-line.
- 13) Form rain loop and ground suitably where T-line enters house.
- 14) Insulating tubes, available in most major catalogs, fit into a drilled hole in the wall and make installation neat appearing but—more functionally—prevent contact with any metal inside the wall structure.
- 15) Use only enough T-line to reach the receiver. If slack must be left for moving the receiver, never coil the excess wire behind the set.
- 16) If several antennas are used for DXing, such as indoor or remote dipoles for E-skip, use the clothespin-type clips for rapid removal.

Check your T-line periodically after installation for trouble signs. Contaminants in the air, strong winds, or squirrels with unusual appetites can ruin a T-line. Reception that "just isn't like it used to be" is often traced to cracked, open, or poorly insulated T-lines. Good luck!

(Next month: hopefully, the return of "Understanding Polarization.")

73, Dave Janowiak

CCI (continued from page 45)

SEPTEMBER 1977

Identifications sent in by Ken Simon:

Scott Levitt, June 27, ch 2, WFET checks. June 28, ch 4, "Nanny" not WTVJ.

David Leibold, May 7, ch 4, "Space 1999" is WTVJ.

Roy Horsley, May 11, ch 4, probably XHTV or net. May 12, ch 2, "Zoom" is WFET.

Good to see all of you who were at the convention. Until next month, 73s!

*Barbara*





Post Office Box 202 - Whiting, Indiana 46394  
**WORLDWIDE TV-FM DX ASSOCIATION**

**TOUGH  
TO BEAT!**

**Established 1967**

SERVING THE  
VHF-UHF DX  
ENTHUSIAST



DUES: USA and Canada, \$11 (via first class); overseas, \$18 (via air mail).

The VHF-UHF DIGEST is the official publication of the Worldwide TV-FM DX Association. WTFDA is a non-profit organization and a member club in the Association of North American Radio Clubs (ANARC).

Persons contributing their efforts for the Worldwide TV-FM DX Association do so without any monetary compensation. Dues and all other revenue cover printing, postage, and other expenses.

The WTFDA is governed by a five-man board of directors, now composed of Morrie Goldman, Mike Hogan, Clarke Ingram, Pete Oprisko, and John Zondlo. ANARC representatives are Morrie Goldman, Clarke Ingram, and Pete Oprisko.

EDITOR-IN-CHIEF.....Clarke Ingram	COMPTROLLER.....Gary Olson
PUBLISHER.....Pete Oprisko	BOOKKEEPER.....Bruce Elving
CIRCULATION.....John Zondlo	PROCESSING.....Dave Janowiak
DISTRIBUTION.....Mike Hogan	LITERATURE.....Morrie Goldman

**S U P P L I E S and D X L I T E R A T U R E** WTFDA member rates only.

REPRINT SERVICE.....	Articles from May 1972 to the present are now available. A complete 1976 catalogue can be obtained from WTFDA HQ.	
VUD Back Issues.....	Available: Nov 1973 issue to the present. Sent by first class or special book rate.	50¢ each
BEYOND SHORTWAVE....	An introduction to TV, FM, and V-U radio DX written and edited by prominent DXers.	\$1.00
TV STATION GUIDE....	An accurate listing of North and Central American TV stations, featuring maps for each channel pinpointing their locations.	\$3.00; nonmember price, \$5
THE FM ATLAS AND... STATION DIRECTORY (Newest Edition!)	An accurate and detailed FM listing with maps and many special articles, by Bruce F. Elving, VUD FCC-FM News column editor.	\$3.50 via First Class Mail
UHF TRANSLATOR..... DX GUIDE	A complete listing of US UHF translators; notes call, location, power, and primary. Also: a section on DXing The Translators.	Sold Out (No Longer Available)
Club Rubber Stamp...	Official WTFDA emblem, as at top of this page, but 37 mm in diameter. Order from Weldon Patterson-Box 25-Adolph, MN 55701.	\$3.50
WTFDA Stationery....	Features the official WTFDA emblem as at top of this page printed in blue on bond.	45 sheets \$1.00
DX Log Sheets.....	These sheets punched for a 3-ring binder help to keep DXers' running logs orderly.	Pad of 100 \$2.50
VUD Boxes.....	Attractive cases designed to keep copies of the VHF-UHF DIGEST neat and organized.	\$1.50 each
Station QSL..... Report Forms	For requesting QSLs (verifications) from TV and FM stations. Now offset printed!	45 sheets \$1.00
DX Column..... Report Forms	For reporting to the numerous DX columns printed each month in the VHF-UHF DIGEST.	Free for a SASE

All columns and feature articles to be printed in any VUD issue should be sent to editor Clarke W. Ingram, 5201 Colewood Drive, Pittsburgh PA 15236. All information for VUD columns should be sent to the appropriate editors; all club business (supply orders, etc.) should be sent to HQ in Whiting.

SUPPORT WTFDA BY PARTICIPATING---REPORT TO COLUMNS AND PURCHASE SUPPLIES.

**Serving VHF·UHF DX Enthusiasts WTFDA**