

Vhf-Uhf DIGEST

The Official Publication of the Worldwide TV-FM DX Association

JUNE 1999

6640 South Broadway
Eureka, CA 95503
707.443.1621
FAX 707.443.6848

KKHB

105.5 fm

KKHB Radio Coverage
Frequency
105.5 FM
Effective Power
100,000 Watts
Estimated Market
Population more than 100,000
(Contour .5mv/m)

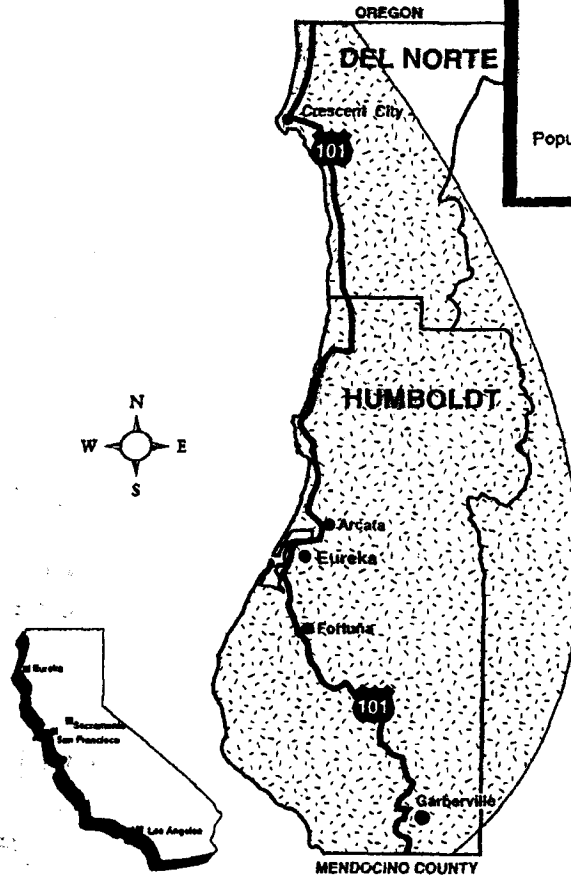

WORLDWIDE TV-FM DX ASSOCIATION
PO BOX 501 - SOMERSVILLE, CT 06072



OPINIONS EXPRESSED IN THIS PUBLICATION ARE THOSE OF THE INDIVIDUAL CONTRIBUTOR AND DO NOT NECESSARILY REFLECT THE VIEWS OF THE PUBLISHER OR BOARD OF DIRECTORS. WE RESERVE THE RIGHT TO EDIT MATERIAL TO MEET PUBLISHING STANDARDS. UNLESS PREVIOUSLY AGREED UPON IN WRITING, ALL MATERIAL SUBMITTED FOR PUBLICATION IN THE VHF-UHF DIGEST BECOMES THE PROPERTY OF W.T.F.D.A.

REPRODUCTION OF MATERIAL FROM THE VHF-UHF DIGEST WITHOUT PERMISSION OF W.T.F.D.A. IS PROHIBITED. INDIVIDUALS AND OTHER ORGANIZATIONS ARE GRANTED SUCH PERMISSION PROVIDING PROPER CREDIT IS GIVEN TO THE SOURCE.

ANNUAL DUES: \$24/year: U.S. addresses

\$26/year* to Canada

(payable in \$38/year* for airmail service to all other U.S. funds) countries. (*Payable in U.S. funds)

first class mail

11/99

BILL NOLLMAN
11 HIDDEN OAK DR
FARMINGTON CT 06032

WORLDWIDE TV-FM DX ASSOCIATION

Serving the VHF-UHF Enthusiast

THE VHF-UHF DIGEST IS THE OFFICIAL PUBLICATION OF THE WORLDWIDE TV-FM DX ASSOCIATION, DEDICATED TO THE OBSERVATION AND STUDY OF THE PROPAGATION OF LONG DISTANCE TELEVISION AND FM BROADCASTING SIGNALS AT VHF AND UHF. WTFDA IS GOVERNED BY A BOARD OF DIRECTORS: TOM BRYANT, GREG CONIGLIO, BRUCE HALL, DAVE JANOWIAK, AND BILL THOMPSON.

Editor/Publisher: Bill Thompson

Circulation: Mike Bugaj Comptroller: Dave Janowiak

Editorial Staff: Tom Bryant, Greg Coniglio, Victor Frank, George W. Jensen, Jeff Kruszka, Russell Miller, Fred Nordquist, Doug Smith, Thomas J. Yingling, Jr., John Zondlo

ANARC Representative: Jim Thomas Back Issues: Dave Nieman

Original Cover Design: Harry Hayes

FROM THE STAFF:

DX MEXICANO! For years, it seemed almost impossible to get accurate information on Mexican broadcasting operations...and that was when the stations were easier to ID. Now, more and more sources are appearing that offer help in this often frustrating area. WTFDAer Danny Oglethorpe has a "DXer Guide to Identifying Mexican TV Stations" on the web at <<http://www.geocities.com/CapeCanaveral/cockpit/5099>>. Of course there's that treasure chest of Mexican FM information compiled by John Zondlo and Fernando Garcia at <<http://members.aol.com/findxweb>>. From those sites you will find links to many more helpful resources. The official source of Mexican broadcast information comes from their government's equivalent of the FCC which is located at <<http://www.sct.gob.mx/infraestructura.html>>. Although that home page currently states that the site is 'under construction', all the links seem to be operational. If you don't have a computer, stop by the nearest public library. Most now have on-line facilities and will show you how to use the equipment. Many also offer free e-mail access.

CONVENTION UPDATES:

**WE HAVE BEEN PUBLISHING AN INCORRECT PHONE NUMBER FOR
WTFDA CONVENTION ROOM RESERVATIONS.
PLEASE CALL DAYS INN, LEDGEWOOD, NJ AT 973-347-5100.**

WTFDA Our 1999 Convention will be hosted by Rick Shaftan July 16-18 in NW New Jersey. Pre-registration, which includes food and beverages, will be \$25. Make your check payable to: **Mountaintop Media** and mail to Box 578, Sparta, NJ 07871. There's more convention info elsewhere in this issue.

IRCA '99/DecalcoMania Holiday Inn-Boardwalk Hotel, Las Vegas, Nevada, June 25-27 1999. Reservations 1-800-635-4581 (mention code I-R-C). Convention registration - \$35. Host is Mike Sanburn, PO Box 1256, Bellflower CA 90707-1256, 310-614-1444.

NRC: Holiday Inn, Bridgeport WV on Sept 3-6, 1999. Reservations 1-304-842-5411, \$70.95 for two double bed room, no limit on how many in a room. Convention registration - \$35. Host is William Swiger, One Casey Ln, Bridgeport WV 26330, 304-842-4635.

ODXA: "Radio Fest 99"... 9/24-26 at the Ramada Inn & Convention Centre, Oakville, Ontario. TV and FM DXers are welcome. Contact the Ramada Inn by telephone (905)849-5950, toll free 1-800-357-0880.

2



WTFDA MAILBOX

P.O. Box 501
Somerville, CT 06072

Mike Bugaj

lkon@netcom.com

GETTING READY FOR E-SKIP!

Well, I could fell it in the air last month. And it finally got here. I'm talking about E-skip. A couple of minor openings were reported around the 28th of April, but the week of May 10th to the 15th was not that shabby in much of North America. I had my first FM Es on the afternoon of the 10th into Louisiana. It didn't last long, but it was a start. Lets hope we have so much this season we actually get tired of it!

We have another new WTFDAer this month. We'd like to say hi to **Brian Corrigan** from Garden City, MI. We have renewals from **Ed Kowalski, Gus Mancuso, Larry Weisberg, Dan Oetting, Rich Wertman, Mike Cherry, John Hourigan, Fred Nordquist, Bill Burrows, Mike DeRoo, Eric Fader, David Shapiro, James Montgomery, George Mileon, James Ivil** and **William Thompson**. Good things are happening with the club. You got a taste of that last month. Thanks for hangin' in there with us and you will continue to see more good things happen!

DTV HITS COLUMBUS! Here's an email from **William Mitchell**. He's not too happy either. William writes: "Recently WBNS-TV began daily testing of their DTV Ch 21. Their transmitter is about 3-4 miles from my 8-bay CM UHF preamped antenna. During the on-air time, channels 20 and 22 (Athens and Dayton OH) simply disappear, replaced by snow. Later when ch 21 ceases operation, they magically return. The snow cross-modulation extends as far up as ch 45, though lesser in magnitude, changing a fair-to-good picture to poor-to-fair. I will remove the preamp as it is most certainly overloaded by ch 21. I may try substituting a preamp with better headroom, although the close proximity of the transmitter and already high gain of the 4228 CM antenna may result in no improvement. When the remainder of the stations in Columbus begin their DTV testing, the weak UHF signal analog band may cease to exist for me, surrounded as I am by numerous transmitters of various VHF and UHF frequencies. My UHF DX hobby will have to move to a more remote location 75 miles from here where I have a cabin. I am curious to know what others have experienced." Well, the good part is that both you and **Dave Nieman** have cabins that are away from everything. The rest of us are not that lucky. This is a good place to get your DTV woes off your chest. It's good therapy, and our fee is reasonable!

GOODIES FROM SKYWAVES. I pulled these items from *Skywaves*, the dx publication of the British FM & TV Circle. This first item hit me as roll-on-the-floor funny, however it just might be my strange sense of humor. Read it yourself...your results may vary:

Postal Problems. This is a problem which rears its ugly head on what seems to be a fairly regular basis. You would think that our chaps down at the PO would be able to distinguish between "Boarhill Grove" and "Bloomer Wood View", wouldn't you? Not so. Bloomer Wood View is the small street at the end of our 'close' and the two number 15s frequently receive each other's mail. This does not explain why a small percentage of the mail is disappearing. Excuse the sarcasm BUT...our postmen obviously cannot cope with the fact that quite a lot of streets around here have the number 15; it must be very confusing to them."

Subject: Y2K...Final Committee Report. "Our staff has completed the 3 years of work on time and under budget. We have gone through every line of code in every program in every system. We have analyzed all databases, all data files, including backups and historic archives, and modified all data to reflect the change. We are proud to report that we have completed the "Y-to-K" date change mission and have now implemented all changes to all programmes and all data to reflect the following new standards: Januark, Februark, Mak, Julik, and Sundak, Mondak, Tuesdak, Wednesdak, Thursdak, Fridak and Saturdak. I trust that this is satisfactory."

Did you hear this one? Two antennas get married. The wedding was filled with static but they had great reception. Thank you, **Karl Zuk**, for posting this gem on amfintvdx and not getting kicked off the list because of it.

WORK SKIP OPENINGS AS THEY HAPPEN!

Logon to Internet IRC...the IRCNET Network, channel #WTFDXA
mIRC or Microsoft Chat will get you there...email me for info!

3

THE MAILBOX MERCHANDISE MART IS OPEN! Bill Nollman has a couple of good DX machines for sale. Bill found that the only rx capable of handling the overload at his new Farmington, CT home is his Yamaha-T85. So, with a heavy heart Bill decided to part with some of his equipment. Here is Bill's description of what he has to sell:



Carver TX-11A

1. Carver TX-11A FM Stereo/AM Stereo Tuner. \$600 plus \$15 shipping in USA
 - * .05mhz tuning steps, i.e., 99.9, 99.95, 100, 100.05...
 - * .1mhz tuning steps, i.e., 99.9, 100, 100.1 etc.
 - * AM is normal 10khz steps.

*Incredible dx tuner with major modifications to IF filters included. I have used this tuner for the past...15 years!!! It was factory repaired by Carver last year. The IF filters are switched with relays and uses the two buttons on the front for wide/narrow/super narrow switching. It equals the Onkyo for selectivity and sensitivity. Audio is the best I've heard with the multipath and noise reduction buttons off. With them on, the signal is very noise-free.

2. An Onkyo T-9090-II for sale with remote. \$450 plus \$15 shipping. It features .025mhz tuning steps (99.5, 99.25, 99.5, 99.75, etc). Incredible dx tuner with no modifications needed to the ifs. Interchannel muting is defeated so it feels like tuning an analog tuner (the feature can be re-enabled). Has an analog signal meter jack (meter not included but Bill can get one for an extra cost), original box (no manual), sells for around \$500 new without the mods.

Bill also has a CM 7475 UHF Hi-gain amp for sale for \$50 (never used), CM 9523 Antenna alignment bearing for \$15 (also unused), and CM 9034 12" wall mounts for \$24. Shipping is included on these three items. Everything is guaranteed! Email Bill at lsnwnn@home.com, or call 860-676-8729.

Jeff Kadet has sent in an SOS for a Channel Master Hi-Q trap for channels 7-13. If you can help Jeff, send him an email at jkadet@macomb.com. If I'm not mistaken, Jeff is also looking for any old AIPA bulletins or DX Horizons that may still be floating around out there. If you have any of these, let me know and I will tell Jeff. Thanks!

WTFDA TV STATION GUIDE UPDATE. Good news from Doug Smith: "The maps have been drawn and the Canadian/Mexican borders added. Channels 2-5 have been printed. I may get a few more channels printed tomorrow but the rest will probably have to wait until after the Dayton Hamvention. Many thanks to Greg for the Canadian/Mexican maps. They worked out amazingly well and were much easier to paste into place than I expected. Stations near internal borders (like the Monterrey stations, the Lloydminster Alberta/Saskatchewan stations, and the Ottawa stations, most of which transmit from Quebec) all seemed to end up in the right places". And while we're at it, a computer problem caused a delay in getting the FM Atlas into print. Bruce Elving reported a two month delay, which should put the deadline sometime into June.

WHAT ARE YOU LOOKING FOR? If it's tuners, receivers, or other assorted gear, you could spend time checking out flea markets, garage sales (otherwise known as yard sales or tag sales depending on what part of the country you live in) and junk shops, but the best flea market of all might be in your own home and more specifically on your computer. Over the past few weeks I've been on eBay (www.eBay.com) looking at Carver equipment, and Onkyo and McIntosh stereo tuners. I've seen TX-11/11As up for bid, as well as a McIntosh MR-80. If you visit the site, do a search for the Manufacturer of the equipment you want to look for. You'll find plenty, and you might just end up with a great piece of gear at a fantastic price!



LAST BUT NOT LEAST... In case you needed it, the address for Scala Electronics Corp (mentioned in the last VUD) is PO Box 4850 Medford, OR 97501. David Shapiro wrote: "I really dig the new Websittings Column." Hey Dave, every once in a while the Mailbox column isn't all that bad either...right Dave...Dave? Uh, have a great month and we'll see you again next month! -Mike

MONSTER E-SKIP ANTENNA!

Installation Baffles Neighbors

Mike Bugaj

It's the E-Skip set up that will startle your neighbors. It's the Dxing machine that will make them think you've really lost it this time. It's the installation that will have them walking on the other side of the street, staring oddly at your house. And, if your name is Jeff Kadet, they will be talking about you!

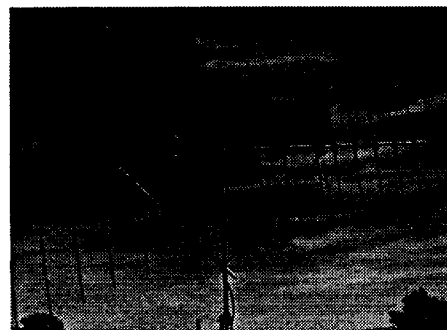

Figure 1 Jeff's Channel Master 1110

Jeff is dead serious about high-band E-skip this summer. But, to give Es a fighting chance on channels 7, 8 and 10, he needed to knock down the signal strengths of the locals on those channels. And he just happened to have a spare Channel Master 1110 monster laying around.

The first thing Jeff did was to vertically polarize his CM-1110. This was no small feat since the antenna itself measures almost 16 feet long with a width of almost 8 feet in places. Jeff went to a large national home-improvement chain and bought a ten foot curtain rod to use as a mast. Then he added two fibreglass rods for support. Then he and his helper, fellow Dxer Frank Merrill, tilted the antenna 10 degrees above the horizon in order to maximize the capture of the Es signals skipping in over the horizon. They set the antenna so that it sits about ten feet off the ground.

Jeff says the CM-1110 was probably the best VHF TV DX antenna ever made until it was discontinued. The Crossfire and others had more gain, but the 1110 had a narrower pattern which was more important for separating stations. The antenna was mounted at ten feet to make reception of local stations as poor as possible. The purpose of the vertical polarization was to attenuate these signals even more. This particular installation works only for E-skip. E-skip signals bounce off the E layer of the atmosphere as if it were a distorted mirror. So when the signal bounces back down to the receiving antenna the polarization is a complete mishmash of polarities. The polarization of the incoming skip signals is something other than horizontal, but the vertical polarized antenna has no trouble picking up the station. And since height is not too important in the reception of skip signals, an antenna mounted close to the ground will still pick up the skip signal instead of a local on the same channel.

Jeff mentioned that since 1983 he has seen over 260 stations by E-skip using a five element vertically polarized low-band antenna sitting ten feet above ground. This is his first hi-band set up. Typically at least one opening each year produces Es on channel 7 or above. He has seen high band Es before. Some of the high band stations he has seen are CIPA-9 in Saskatchewan, a CBC hockey game on channel 11, and Es **Figure 2** The ten degree tilt CCI under his locals KHQA-7, WQAD-8 and WGEM-10, but these were all seen on a CM-1110 mounted at a height of 47 feet above ground.

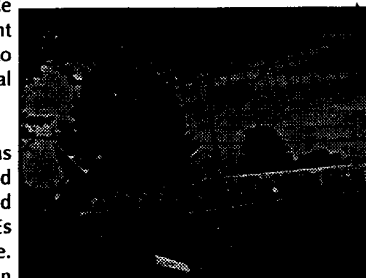

If you should ever attempt to do this yourself, be warned that this job is *not* a one man job. Two persons are a must. And Jeff himself wonders: "Will it last a week...a month...a summer... ten years? Only time will tell. I don't remember anybody attempting this before." Well, they probably haven't. Good luck, Jeff!

Translator/DTV/LPTV NEWS

Here is a partial edited text of remarks made by FCC Commissioner Gloria Tristani before the New Mexico Broadcasters Association in Albuquerque, MN on April 30, 1999 concerning DTV, LPTV and Translators:

Let me start with translators. You all know much better than I how important translators are to our broadcast system, especially out here in the mountain states. Translators may be "secondary" as a matter of law, but to the people who depend upon them to receive broadcasting service, there's nothing "secondary" about them. I see a couple of big challenges facing translators over the next decade. First, there's the danger of displacement, largely caused by the allotment of a second channel to full-power stations to transition to DTV. Second, there's the problem of how translators themselves transition to digital. Let me address both of those.

First, as you all know, the threat of displacement is real. We now have almost 5,000 TV translators out there. With full-power stations receiving an extra channel to transition to digital, and with the impending loss of channels 60-69, the squeeze is really on. In the next few years, hundreds of secondary services like translators and low power TV stations may find themselves looking for a new home.

We've already taken numerous steps to try and minimize the displacement. For instance, we tried to assist translators in relocating to new channels. We changed the filing rules, so that those of you in the 60-69 band or who are being displaced by a DTV channel don't have to wait for a filing window. You can ask for a change at any time on a first-come, first-served basis. You can also keep operating on your current channel -- including channels 60-69 -- until the channel is needed for primary operations and a conflict arises. That might give a lot of stations the ability to keep operating throughout this transition period. I'd encourage you on channels designated for public safety to coordinate with your local officials. They should understand the valuable service you provide to the community. You may be able to find a way to keep your service on the air during the transition period.

Just to give you an indication of the scope of the displacement problem, the first day that translator and low power stations could file for replacement channels to avoid DTV conflicts was last June 1. On that one day, we received over a thousand translator and LPTV applications for replacement channels. Of those, 280 applications were mutually exclusive. We've given these parties a chance to resolve their mutual exclusivities through engineering solutions. And we relaxed several of our technical rules to give translator operators additional flexibility in reaching an agreement. But if they can't, the applicants will have to participate in an auction to determine who gets the channel.

Speaking of auctions, a couple of weeks ago we released our final broadcast auction rules. As you know, Congress now requires us to auction broadcast channels -- except non-commercial channels -- when broadcasters file mutually exclusive applications. I'm glad that we have final rules so we can get these auctions going, and that we'll be able to start assigning new translator licenses again. As you may know, there haven't been any filing windows for new translators since 1994. Now that the auction rules are in place, we can and should begin planning for a filing window that will permit small rural communities to receive additional programming services -- like some of the emerging networks -- that are commonly available in larger communities.

But I also wanted to mention a couple of specific auction rules we adopted that recognize the unique circumstances faced by secondary services like translators. One, we have strict anti-collusion rules for most broadcasters who file mutually-exclusive applications. That means that, in order to preserve the integrity of the auction process, broadcasters are generally prohibited from settling with one another or using engineering solutions to remove the mutual exclusivity once applications have been filed. But our recent Order gave translators some relief from that rule, giving them a period of time to try and find engineering solutions to mutually exclusive applications and thus avoid an auction. This is the effort that the mutually-exclusive applicants who filed on June 1 are going through right now. Two, we established a new entrant bidding credit for entities with no, or very few, other media interests. Specifically, you can get a 35% bidding credit if you have no other media interests, and a 25% bidding credit if you own no more than three other media interests (as long as you don't own any in the same area). In the Order, we held that interests in translators or LPTV stations would not count against you for purposes of the bidding credit. Thus, if you own translators or LPTV stations, even in the same area, you can still qualify for the 35% bidding credit.

So that's what we've done so far to help translators survive during this difficult period. If there's more that we can and should be doing, I hope you'll let me know. One thing I hope we're about to do is seek comment on creating a new Class A service for low power TV stations. This proposal would recognize the valuable contribution these stations provide to their communities and ask whether they should be given additional protection against displacement from any new stations coming on the air. If we ask that question about low power, I'm committed to asking it about translators as well. Should some types of translators be given primary status vis-a-vis new entrants? As translators struggle to survive and to continue serving their communities, I think it's a question well worth asking.

Translators have been so concerned with just surviving that the second challenge has gotten less attention -- the transition of translators themselves to digital. There aren't many sure things in the unpredictable world of telecommunications. But if there is one sure thing it's this -- that all forms of communication, from voice to video to data, eventually will transition from analog to digital. My sense is that not enough research and development work has been done on how translators will make that transition. What are the unique technical issues that need to be resolved for translators to go digital? And, as important as the technical issues, what are the economic issues involved? Many translators are non-profit, community-run enterprises. How much will this transition cost them? And how will they pay for it?

Now let me talk about another subject that I hope we can work together on -- low power radio. I know how deeply concerned you are about the proposal that the Commission made in February. I want you to know that I've heard your concerns and want to continue that dialogue.

Let me start by talking about why we put this idea forward. As all of you are aware, the radio business has undergone tremendous consolidation over the past few years. Since the 1996 Act was passed, the number of radio station owners is down about 12%, even though the total number of stations has actually increased by almost 4%. As the business becomes more and more consolidated, it gets harder and harder for new people to get into the radio business and more tempting for existing owners to cash in and get out.

My colleagues and I have heard from hundreds of Americans who would like to use the airwaves to speak to their communities, but can't under our current rules. Most of the people I hear from are not pirates or extremists. They're groups like churches, community groups and universities. Creating an outlet for those voices is what motivates this proposal. Hopefully even those of you who ardently oppose this idea will admit that the goal is a worthy one.

To me, proven interference and hindering the transition to digital would be valid reasons not to proceed with low power. But I've heard other objections to the proposal that I'm not as comfortable with. For example, I've heard some people inside and outside the Commission say that low power isn't a good idea because we already have "enough" broadcasters. They say that there are already enough different formats out there to serve the public. And they worry that additional stations competing for ad dollars will just make it harder for existing stations to survive.

Let me address both concerns. First, on the point that there's already "enough" diversity out there, I'm very uncomfortable with the government making that judgment. I don't think the government should be in the business of rationing speech, deciding that we've got enough of one kind of speech and telling other speakers to go elsewhere. I certainly don't want government making those kind of decisions and I hope that those of you who are dedicated to the concept of free speech would agree with me. The issue of additional economic competition for existing broadcasters is a difficult one and one I struggle with. My staff and I have heard from many, many small broadcasters -- some of whom are in this room -- who worry that low power broadcasters could siphon off ad dollars, making it difficult for them to survive.

Here's my current thinking. Generally, I have a lot of faith in the market to produce the best results for the public. But -- and this is a big but -- I believe that competition must be fair. Many of you have said that you are willing to compete, but want to make sure that it's a level playing field. And I don't blame you. That's why we proposed that 1,000-watt low power stations generally would have to comply with the same Part 73 rules that you do. If you think this isn't enough to create a level playing field, let us know. That's what this comment period is for. Another way to get at this problem would be to make all low power stations non-commercial.

So, to summarize. Low power radio is only a proposal at this stage. We are gathering the facts. We need to hear from you, especially your concerns about interference and your ability to transition to digital. Comments are due June 1. Reply comments are due July 1. If low power makes sense, I am committed to ensuring that existing broadcasters can compete on a level playing field and that translators are not unduly threatened

Next Stop: Northwestern New Jersey



The 1999 WTFDA
Convention will be held
in northwest New Jersey.
All calendars in your home
should be highlighted for
July 16-18, 1999.
**MARK YOUR
CALENDARS
NOW!!**



WHERE
to sleep

The recommended lodging facility is:
Days Inn/Ledgewood, 1691 Route 46 West, Ledgewood, NJ 07852
Tel. 973-448-1100
You can also book lodging by credit card at any of the major
reservations secure websites.



HOW MUCH
does it cost??

Lodging at the Days Inn/Ledgewood begins at \$69.00 plus tax.
This is NOT a special club discount.
Convention registration is \$25.00. This includes food, beer, soda,
soda, more soda (and more food).
All convention registration payments MUST be made to
Mountaintop Media.



WHO TO
talk to

TO PRE-REGISTER:
E-mail Rick Shaftan at shaftan@ptd.net, or, if you don't have e-mail
access, his mailing address is: Box 578 Sparta NJ 07871
You can also contact Rick at either address for further information.
REMEMBER, when making payments for the convention, be sure
checks and money orders are paid to Mountaintop Media.

PHOTO-NEWS

Jeff Kruszka, Editor
5024 S. Braxton Ave.
Baton Rouge, LA 70817
JTKruszka@worldnet.att.net

June 1999

Let's finish up with Bill Eckberg's photos from Dixon, IL:



WTVH-5 Syracuse, NY
671 mi Es seen 6/1/98
@1730 CDT
"short skip"

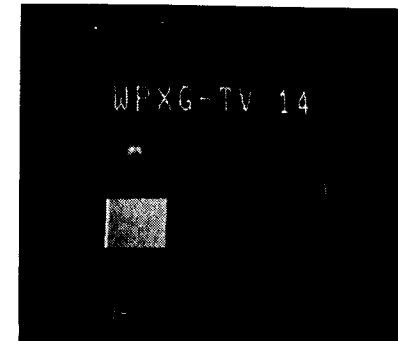

WPXG-14 Suring, WI
231 mi Tr seen 7/16/98
@0950 CDT
"new on air"

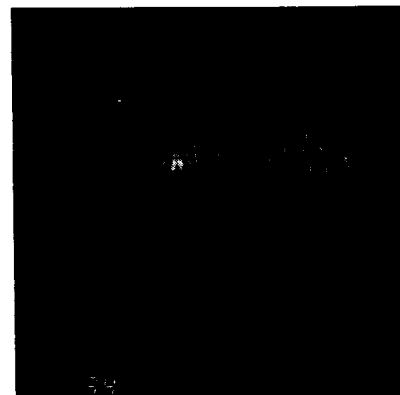

KJTV-34 Lubbock, TX
875 mi Tr seen 9/26/98
@0830 CDT



KCIT-14 Amarillo, TX
803 mi Tr seen 9/26/98
@0900 CDT
"Neat xtr list!" - JTK

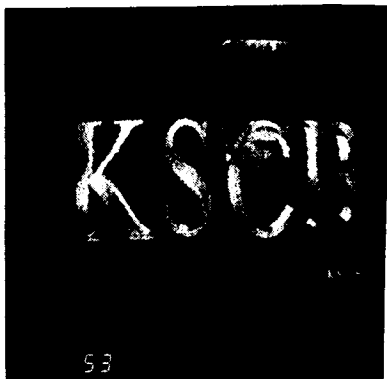

K53EG Sioux Falls, SD
383 mi Tr seen 10/28/98
@0745 CST
"fake ID - Siouxland Christian Broadcasting"



KSNB-57 Springdale, AR
453 mi Tr seen 12/1/98
@0600 CST
"new on air"

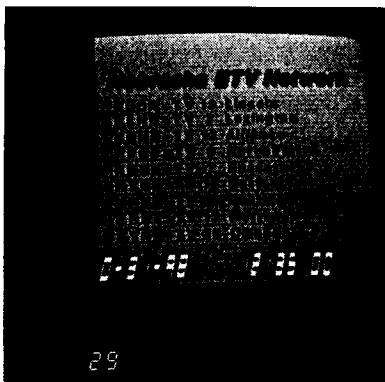

KHNE-29 Hastings, NE
464 mi Tr seen 10/31/98
@0035 CST



Now more some multi-channel ID's from Danny Oglethorpe, Shreveport, LA:

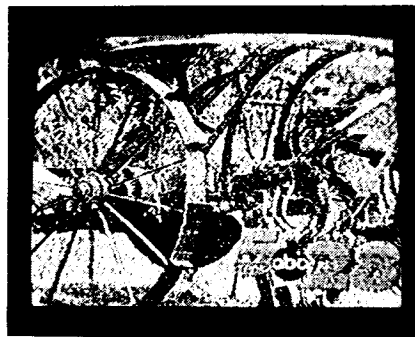

WBKP-5 Calumet, MI
1063 mi Es seen 6/28/98
@2345 CT
"ABC 5/28"



K22EH Longview, TX
57 mi Tr seen 7/8/98
@0530 CT
"UPN 22/48"



CKPR-2 Thunder Bay, ON
1130 mi Es seen 7/15/98
@1700 CT
"TBT 2/5"

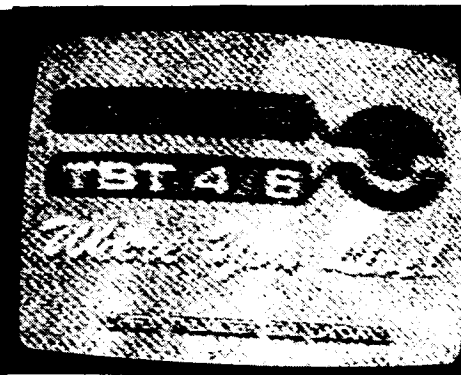

CHFD-4 Thunder Bay, ON
1130 mi Es seen 5/29/98
@1643 CT
"TBT 4/6"

73's, *JOB*



SATELLITE NEWS

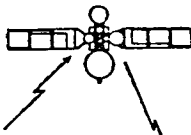

GEORGE W JENSEN
4604 ANNTANA AVE
BALTIMORE MD 21206-4220

Many changes this month - so here goes:

Satcom C4 -

delete - 6 - Madison Square Garden - now on C1

Prevue Guide on 8 - is now TV Guide

The following are part of a major reworking of the digital services on C4 AND G1

add to C4 digital (4DTV)

105 - Encore west 106 - Starz 2 West

107 - BET Movies West 108 - Starz Family west (new)

109 - W A M West

Below is the new Digital (4DTV) line-up on Galaxy 1

100 - HBO East 102 - HBO West 103 - HBO Plus east

105 - HBO Plus West 106 - HBO Signature East

108 - HBO Signature West 109 - HBO Family East

111 - HBO Family West 112 - HBO Zone East 114 - HBO Zone west

115 - HBO Comedy East 117 - HBO Comedy west

118 - HBO HDTV Test 120 - HBO HDTV Test

124 - Cinemax East 126 - Cinemax West 127 - More Max east

129 - More Max West 130 - Action Max East

132 - Action Max west 133 - Thriller Max east

135 - Thriller Max West 150 - Encore east 151 - Encore west

152 - Starz east 153 - Starz West

154 - Starz 2 East 155 - BET Movies east

156 - Starz Family East 157 - Starz Cinema East

158 - Starz Cinema west 159 - W A M East

170 - Action East 171 - Action West 172 - Love East

173 - love West 174 - Mystery east 175 - Mystery west

178 - True Stories east 178 True Stories west

178 - Westerns east 179 - Westerns west

Galaxy 9 - new infomercial channel on 783 ho-hum

Satmex 5 - new line-up

15 0 XHDF - Ch 13 - TV Azteca - Trece Vision - Mexico City

17 - XHIMT - Ch 7 - TV Azteca - Mexico City

15 - Clara Vision

780 - Edusat 781 - Edusat 782 - ITESM - Canal 2 - Edu.

783 - Edusat 784 - Canal 15 - Edusat alsop Classic Arts

Showcase 785 - Canal 22 - Imevision 786 - Edusat

787 - White Noise 788 - Kids Discovery En Español

789 - Canal 22 - Imevision - no audio

790 - Edusat 791 - Edusat 792 - unused 793 - edusat

Anik E2 - KuBand digital - 475 - Food

G E Americom GE1 - Ku-Band - 16 - DirecPC

Spacenet 4 - delete 7 - promos and 10 - Fox Channel East

Telstar 402 - delete ALL FOX FEEDS - now on Telstar 7

Intelsat at 27 West - delete ALL analog feeds to US

That's all for this month - see you in 30 --

If you see anything new or other changes - don't hesitate

to let me know.

"73"s
George

TV News

Douglas E. Smith W9WI
1385 Old Clarksville Pike
Pleasant View, TN 37146-8098
W9WI@bellsouth.net

June 1999

non-commercial station
nc no change

<http://personal.bellsouth.net/~w9wi>

Applications for new stations

St	Ch	ERP	Ht.	City	Applicant	Latitude	Longitude
AL	45^	225	324	Gadsden	WPXH [44]	33-53-27	86-28-13
AZ	20^	500	489	Phoenix	KPAZ [21]	33-20-03	112-03-42
CA	11z	166	887	Los Angeles	KTTV [11]	34-13-29	118-03-48
CA	48^	190	822	Porterville	KPXF [61]	36-17-14	118-50-17
GA	51^	1000	595	Rome	WPXA [14]	34-18-48	84-38-55
IA	39^	1000	611	Sioux City	KMEG [14]	42-35-12	96-13-19
IN	56^	500	297	Bloomington	WCLJ [42]	39-24-12	86-08-50
MO	52^	1000	573	Springfield	KOLR [10]	37-13-08	92-56-56
NC	20^	543	489	Chapel Hill	WUNC [4]#	35-54-00	76-20-45
NC	20^	543	489	Columbia	WUND [2]#	35-54-00	76-20-45
NC	36^	1000	242	Fayetteville	WFPX [62]	34-53-05	79-04-29
NC	50^	200	352	Kannapolis	WAXN [64]	35-15-41	80-43-38
NY	53^	800	279	Batavia	WPXJ [51]	42-53-42	78-00-56
NY	27^	200	373	Poughkeepsie	WTBY [54]	41-29-20	73-56-55
OH	39^	200	292	Canton	WDLI [17]	41-03-20	81-35-38
TX	51^	173	545	Fort Worth	KFWD [52]	32-35-19	96-58-05
VA	31^	1000	280	Portsmouth	WAVY [10]	36-49-14	76-30-41
VT	24^	30	693	Windsor	WVTA [41]	43-26-15	72-27-08
WA	50^	240	719	Bellevue	KBEH [51]	47-30-17	121-58-04
WI	15^	200	280	Eau Claire	WQOW [18]	44-48-00	91-27-57
WI	8^	25	354	Milwaukee	WMVS[10]#	43-05-44	87-54-17
WI	35^	400	353	Milwaukee	WMVT[36]#	43-05-44	87-54-17

Applications in *italics* are for backup auxiliary transmitters. I'm not sure whether the channel 20 application in NC is for Chapel Hill or Columbia - both are listed.

Construction permits granted for new stations

St	Ch	ERP	Ht./Call	City	Applicant	Latitude	Longitude
AZ	31^	794	486	Phoenix	KSAZ [10]	33-20-02	112-03-42
CA	30^	200	606	San Diego	KPBS [15]	32-41-46	116-56-08
FL	39^	417	494	Orlando	WFTV [9]	28-34-07	81-03-16
FL	12^	17.5	436	Tampa	WTVT [13]	27-49-08	82-14-26
KY	17^	60.3	237	Louisville	WKPC [15]	38-22-01	85-49-54
NC	55^	525	628	Goldsboro	WNCN [17]	35-40-29	78-31-40
NC	57^	316	610	Raleigh	WLFL [22]	35-40-29	78-31-40
NV	#6+	100	270	Ely	Kaleid. Fdn.	39-15-53	114-53-35
NV	7-	23	448	Goldfield	Harris Bc	38-03-05	117-13-30
OR	30^	741	528	Portland	KPTV [12]	45-31-19	122-44-53

UT	29^	530	1171	Provo	KUPX [16]	40-39-12	112-12-06
UT	38^	295	1267	Salt Lake C	KSL [5]	40-39-33	112-12-07
WY	7z	20	368	Sheridan	Sunbelt	44-37-20	107-06-55

New stations have been authorized at Bozeman, Montana:

K34FI K49FG K50FN K64FS, all with no offset and 10kW ERP at 45-40-24N/110-52-04W.

And at Twin Falls, Idaho:

K27FT/27n K45FF/45- K60GI/60-s, all with 16kW ERP at 42-43-48N/114-24-52W.

New station permits expired, dismissed, etc.:

St	City	Ch	# permits	St	City	Ch	# permits
NV	Ely	6	2	WY	Sheridan	7	2
NV	Goldfield	7	3				

Applications to change existing stations

St	Ch	ERP	HAAT	City	Call	Latitude	Longitude
CA	56-	2510	917	Anaheim	KDOC-TV	34-13-36	118-03-58
CA	10z		227	San Diego	KGTV		
FL	44+			St. Petersburg	WTOG	27-49-46	82-15-59
IA	18+		309	Davenport	KLJB-TV	41-19-39	90-22-46
IN	9^	19.5		Indianapolis	WISH-DT		
NC	9+		368	Charlotte	WSOC-TV		
OK	14-		358	Oklahoma City	KTBO-TV	35-34-35	97-29-09
PA	2-		295	Pittsburgh	KDKA-TV		
TX	27-			Dallas	KDFI-TV	32-35-21	96-58-12
TX	58z		437	Dallas	KDTX-TV	32-35-21	96-58-12
TX	65z		526	El Paso	KKWB		
VT	41z		693	Windsor	WVTA#		
WI	34z	2250	247	Eagle River	WYOW		
WI	19+			La Crosse	WXOW-TV	43-48-02	91-22-02
WI	52z			Mayville	WWSR-TV	43-26-11	88-31-34

Entries in italics are corrections to the tower coordinates only - nothing has actually changed.

Applications to change construction permits

St	Ch	ERP	HAAT	City	Call	Latitude	Longitude
CA	42^		917	Los Angeles	KWHY-DT		
CT	10^	20.5		New Haven	WTNH-DT		
FL	11^		515	Daytona Beach	WESH-DT	28-36-35	81-03-35
HI	38+	51	632	Honolulu	KAIE#	21-19-49	157-45-24
HI	44z	51	632	Honolulu	KWBN#	21-19-49	157-45-24
MA	46+	1900	247	Norwell	WBFX	42-00-45	71-05-39
NC	64-	1100	352	Kannapolis	WAXN		
NV	39+	1330	357	Paradise	KBLR	36-00-36	115-00-20
NY	44^	990		New York	WNYW-DT		
OH	12^	4.8		Mansfield	WMFD-DT		
PA	46^	200	314	Allentown	WFMZ-DT		
PR	22z	112	602	Mayaguez	WNJX-TV		
TN	40^	1000		Chattanooga	WDSI-DT		

TX	40z		577	Rio Grande City	KTLM		
UT	29^	530		Provo	KUPX-DT		
UT	20+	1644	1171	Salt Lake City	KTMW	40-39-12	112-12-06

Changes granted to existing stations

St	Ch	ERP	HAAT	City	Call	Latitude	Longitude
LA	10z		527	Lafayette	KLFY-TV	30-19-19	92-16-59
ME	8z	120	350	Presque Isle	WAGM-TV	46-33-04	67-48-35
OH	22+	3970	348	Dayton	WKEF	39-43-14	84-15-40
TN	30z	3020	340	Memphis	WLMT	35-16-33	89-46-38

Changes granted to construction permits

St	Ch	ERP	HAAT	City	Call	Latitude	Longitude
CA	25^	302	208	San Diego	KGTV-DT		
IA	23-	4966	613	Ames	KPWB-TV	41-49-47	93-36-56
MO	29-		358	Kansas City	KCWE	39-05-01	94-30-57
NM	25-	100	134	Carlsbad	KUPC	32-26-09	104-11-14
NV	21+			Las Vegas	KVWB	36-00-28	115-00-25
NV	39+	1330	357	Paradise	KBLR	36-00-36	115-00-20
PR	22z	112	602	Mayaguez	WNJX-TV		
TX	55z	3240	143	Lake Dallas	KLDT		
WA	45+	2000	696	Seattle	KHCV	47-30-17	121-58-06
WI	55z		347	Wittenberg	WFXS	45-03-22	89-27-54

KCWE [29] also granted permission to move from channel 32-. The W31BW transmitter site is in Pennsylvania.

Changes expired, dismissed, etc.

St	City	Ch	Call	St	City	Ch	Call
AZ	Kayenta	54	K54CR	CA	San Jose	54	KTEH#

Technical changes on the air

St	Ch	Call	City	What happened
CA	51z	KUSI-TV	San Diego	decrease power 2880=>2820kW, increase tower height 579=>584m, correct coordinates a few meters southwest.
FL	10+	WPLG	Miami	increase tower height by 2m and add beam tilt.
IN	23z	WNDY-TV	Marion	decrease tower height 1m.
MO	15+	KPOB-TV	Poplar Bluff	increase power 389=>776kW, tower height 1m; correct coordinates a few meters northwest.
NM	41z	KLUZ-TV	Albuquerque	increase power 1170=>1200kW, decrease tower height 1266=>1256m
PA	23-	WATM-TV	Altoona	increase power 182=>708kW.
TX	13+	KERA-TV#	Dallas	increase tower height 469=>518m.
WA	33+	KWPX	Bellevue	increase power 14.8=>3720kW, tower height 286=>717m, move about 40km east-southeast.
WA	9z	RCTS-TV#	Seattle	decrease tower height 252=>249m.

New stations on the air or requesting operating license

St	Ch	ERP	HAAT	Call	City	Latitude	Longitude
AR	48+	1410	297	KVTJ	Jonesboro	35-36-16	90-31-18
CA	31^	310	954	KTLA-DT	Los Angeles	34-13-36	118-03-56
CA	56^	501	432	KTVU-DT	Oakland	37-45-19	122-27-06
CA	57^	1000	446	KRON-DT	San Francisco	37-45-19	122-27-06
CT	10^	7.9	342	WTNH-DT	New Haven	41-25-22	72-57-06
FL	63z	5000	157	WPPB-TV#	Boca Raton	26-09-11	80-10-12
FL	57-	2510	135	WFXU	Live Oak	30-33-00	83-00-46
GA	27^	846	332	WAGA-DT	Atlanta	33-47-51	84-20-02
IA	44+	5000	594	KPTH	Sioux City	42-35-16	96-13-22
KY	62z			WBLU	Lexington		
MA	42^	948	288	WHDH-DT	Boston	42-18-41	71-13-00
MA	48+	240	246	WYDN#	Worcester	42-18-14	71-53-51
MI	41^	465	285	WXYZ-DT	Detroit	42-28-14	83-15-01
MI	45^	973	281	WDIV-DT	Detroit	42-28-58	83-12-19
MO	29-	5000	322	KCWE	Kansas City	38-52-16	94-26-15
NM	14-	5000	376	KAPX	Albuquerque	35-24-44	106-43-32
PR	46z	1510	642	WIDP	Guayama	18-16-48	65-51-08

I'm not going to list any facilities for WBLU yet. I have three different applications, all for 5000kW, in my database, but Glen Hale in Georgetown says he doesn't believe it's using anywhere near that much power. It may actually still be operating under the W62CL LPTV license, for 129kW.

Call changes

Was:	Now:	City:	Ch	Was:	Now:	City:	Ch:
WBJH	WLDM	Tusca., AL	23	WHVI-LP	WEEE-LP	Knoxvil., TN	32
W07BZ	WOKB-LP	Orlando, FL	7	W68CG	WGAP-LP	Nashvil., TN	68
K43FB	KOPE-LP	DMoines, IA	43	KWAB	KWAB-TV	Big Spr, TX	4
K58DH	KPTN-LP	StLouis, MO	58	K16BY	KIVY-LP	Crockett, TX	16
new	KBMO	Tonopah, NV	9	K59FQ	KUNU-LP	Victoria, TX	59
KAUP	KFFX-TV	Pendltn, OR	11	KTZZ-TV	KIWB-TV	Seattle, WA	22

Programming changes

Call	Location	Programming
K23EP	El Dorado, AR	new, relays KMCT [39], religious.
CH4289 [63]	Bear Lake, BC	from YTV to Discovery.
WPPB-TV [63]	Boca Raton, FL	new, TBN.
W15AG	Live Oak, FL	relays WGFL [53], WB.
WFXU [57]	Live Oak, FL	new, Fox parallel WTLH [49].
WJAN-LP [41]	Miami, FL	RCN TV news (from Colombia?)
W42AO	Athens, GA	from TBN to relay of WATC [57], independent religion.
KPTH [44]	Sioux City, IA	new, Fox.
W54BK	Chesterton, IN	sold to WHME [46].
W18BT	Gary, IN	sold to WHME [46].
W24AW	Valparaiso, IN	sold to WHME [46].

WBLU [62]	Lexington, KY	new, relays WAOM [67] with UPN.
KADO-LP [15]	Shreveport, LA	back to America's Choice.
WYDN [48]	Worcester, MA	new, religious, some in Spanish.
W30BF	Bangor, ME	sold to religious organization.
WIFYW-LP [41]	Fairfield, ME	sold to 3ABN.
W20BL	Bath, NY	new, relays WYDC [48] Fox/UPN.
WWBI-LP [27]	Plattsburgh, NY	drops UPN, now independent.
XHFTX [57]	Nuevo Laredo, TM	adds UPN sto Fox.
WJFB [66]	Lebanon, TN	from Shop At Home to Military Ch.
K35EU	C. Christi, TX	Tejano videos // KTMV-LP.
K55FX	C. Christi, TX	bilingual religious.
K63EU	C. Christi, TX	PTCB religious, also ID as GLC ("God's Learning Channel").
K68EI	San Antonio, TX	same as K63EU above.
K31EX	San Antonio, TX	GEMS, in Spanish.
WTMW [14]	Arlington, VA	from HSS to Military Channel.
WBVT-LP [39]	Burlington, VT	from WB to UPN.
WFFF-TV [44]	Burlington, VT	adds WB to Fox.
WRRS-TV [52]	Mayville, WI	new, TBN.

The FTN stations in southern Texas (and possibly elsewhere?) have added some English-language religion. WYDN is on the list of FTN affiliates, though I've also received reports of this station not mentioning Spanish-language programming so I presume it's mostly English.

Forum & Other Stuff

Thanks to Eric Bueneman, Michael Condon, Danny Oglethorpe, Jim Ayers, Dave Nieman, Chip Kelley, Glen Hale, Fernando Garcia, Bill Hale, and Matt Sittel for information appearing elsewhere in this column.

Michael is now seeing new WRRS [52] Mayville. This station received its operating license about a year ago, but nobody saw it until mid-April. Mayville isn't exactly an isolated area - it's about midway between Fond du Lac and Milwaukee, and relatively close to Madison too. Incidentally, he also mentions that W43BR Baraboo is IDing as "WRPQ", the calls of the AM station at Baraboo.

WPXJ [51] Batavia, NY should be on the air by the time you read this. Dave Nieman stopped by the site in late April. The tower was about 1/3 complete, and the transmitter already operating into a dummy load. Dave says it isn't a particularly good tower site - the translators they own in Buffalo and Rochester will definitely be needed. (I suspect sites further north and west are unavailable due to Canadian stations CHCH-TV-2 and CICA-TV-51 on channel 51, and image interference to CITS-TV on channel 36. Sites to the south and east are probably restricted due to WTVE in Reading, PA.) On a similar subject, Robert Grant in Detroit says the new WWJ-TV/WWJ-DT (chs. 62/44) tower is under construction, at the 800' level as of late April.

For some reason, the Public Notices indicate WBBS-TV [60] West Chicago, IL was granted an operating license for a new station! This station was actually deleted some 10-15 years ago, when it merged with another channel 60 station with which it had been sharing time. I believe WPWR-TV, then licensed to Aurora but now on channel 50 from Gary, Ind., was the other station involved. Maybe someone else can fill us in to the details of this rather complicated bit of Chicago-area TV history?

I had to delete almost all LPTV information this month, to keep the size of the column within reason. I am seeing some weak skip in channel 2 as I type, looks like the season is getting started here. Others have had a pretty good early season already. Good luck!

FM NEWS

JUNE 1999

EDITOR: GREG CONIGLIO
90 SLATE CREEK DRIVE APT. #3
CHEEKTOWAGA, NEW YORK 14227
E-MAIL: coniglio@localnet.com
WEB: http://www.geocities.com/~wgrc

Most of the information appearing in this column is courtesy of:

M STREET JOURNAL - 54 MUSIC SQUARE EAST SUITE 201 - NASHVILLE, TENN. 37203
PHONE: (609) 883-3321, FAX: (609) 883-5596, E-MAIL: MstreetTom@aol.com

KEY TO ABBREVIATIONS:
&: satellite programming
AF: New frequency allocation **accepted for filing** for a new FM license
AFA: American Family Association
CC: **call letter change**
CL: **city of license change**
CX: a **construction permit** has been **canceled**
C1,C2,etc.: a change in status to that FM license **class**
DA: **directional antenna**
DE: station has been **deleted**
FC: **format change**
GA: **granted amendment** to the table of FM allocations
GE: **granted extension of construction permit**

GX: **granted replacement** of expired permit
LC: **license to cover filed** (means station is ready to come on air)
MC: **multiple-city legal ID**
NC: **no change yet** on a reported change/permit
ND: **non-directional antenna**
NO: **not on the air**
NS: **new station** granted
NW: **new station** signs on
OSA: **one-step application** granted for change
PA: **proposed amendment** to change FM table of allocation
PC: **power change** on the air (> for increase, < for decrease, when known)
PG: **power change** granted (> for increase, < for decrease, when known)
QC: **frequency change** occurred
QG: **frequency change** granted
RA: **silent station returns to air**
RE: **station requests extension** on permit
RX: **station requests replacement** of expired permit
SG: **slogan change** or update
SI: **station is silent**
XA: **dismissed amendment** to FM allocations
XC: **transmitter site change** occurred
XG: **transmitter site change** granted



UNITED STATES

ALABAMA:

Addison: WYAM 105.7 FC to urban "Live 105.7"
Georgiana: WFXX 107.7 adds ABC A/C (&)
Glencoe: WGMZ 93.1 FC to classic hits (Gadsden)
Sheffield: WAKD 89.9 increases to 236 ft, XC: 34-50-11 / 87-37-20
Tallasee: WQNR 99.9 CC (ex WACQ), FC to modern rock
Tuskegee: WTGZ 95.9 FC to ABC classic rock (&)

ALASKA:

Kodiak: KRXX 101.1 FC to ABC hot AC (&)
Yakutat: KJFP 103.9 NO-CX-DE, SI

ARIZONA:

Flagstaff: KLOD 100.1 NW, rock "Loud Radio", CC (ex KLOD)
Fountain Hills: *NS 89.1 1.4 kW, 935 ft.
Kingman: *NS 90.1 AF
Munds Park: *NS 106.1 GA: add class A
Sedona: KQST 102.9 FC to rhythmic oldies
Somerton: *** 99.9 PA: add class C3
Wellton: *** 95.9 PA: add class A

ARKANSAS:

Eudora: KAVH 101.5 XG: 33-11-58 / 91-15-39
Fayetteville: *NS 90.1 16 kW (v), 7.1 kW (h), 466'
Fayetteville: *NS 88.3 470w (v), 262 ft.

ARKANSAS:

Gosnell: KAMJ 93.9 NW, urban "K-Jam"
Judsonia: *** 95.3 PA: add class A
Kensett: *** 105.7 PA: add class A

CALIFORNIA:

Atwater: KVRQ 92.5 FC to rhythmic oldies
Bend: K212DF 90.3 NS-10w, DA: KAWZ-ID
Davis: KDV5 90.3 PC> 9.2 kW, 105 ft, class B1, XC: 38-32-29 / 121-45-03
Desert Center: KZAL 105.5 LC
Fremont: KCNL 104.9 PG> 5.7 kW, 338 ft.
Grass Valley: KLV5 99.3 CX CP for 490w, 1089 ft.
June Lake: *NS 90.9 3.3 kW, 1407 ft.
Lenwood: KBTW 104.5 CC (ex KBIW)
Morro Bay: KLMM 94.1 CC (ex KBZK), FC to regional Mexican (San Luis Obispo)
Mount Shasta: K215CU 90.9 NS-13(v): KAWZ-ID
Paso Robles: KLUN 103.1 CC (ex KBZX), FC to Spanish hits (San Luis Obispo)
Ronherk Park: KRPO 104.9 PC> 2250w, 548 ft, XG: 38-23-31 / 122-40-40
San Mateo: K215CU 107.7 NS115w, DA
Santa Ana: KWIZ 96.7 PC> 6 kW, 203 ft, DA
Soledad: *NS 89.9 250w(v), 305 ft.
Taft: *** 106.5 PA: add class A
Talmage: K204DG 88.7 NS-10w(v), DA: KAWZ-ID
Thermal: *** 103.5 PA: add class A
Winton: KLOQ 98.7 inc. to 299 ft. XC: 37-16-41 / 20-37-35



FM NEWS PAGE 2

JUNE 1999

COLORADO:

Bayfield: *** 95.3 PA: add class A
Beulah: *** 93.9 PA: add class C3
Canon City: KSTY 104.5 QC from 103.9, PC> 6 kW, 46 ft, XC: 38-18-54 / 105-12-40
Center: *** 105.3 PA: add class A
Estes Park: KRKI 102.1 dec. to 171 ft, XG: 40-17-34 / 105-33-05
Grand Jct: KSNJ 100.7 LC
La Jara: *** 92.1 PA: add class A
La Veta: *** 103.3 PA: add class A
Pueblo West: KYZX 103.9 QC from 104.5, PC< 1750w, (cir) 2158 ft, XC: 38-44-40 / 104-51-41, CL change from Pueblo, CO
Sawpit: *** 99.1 PA: add class C3
Walsenburg: *** 101.3 PA: add class C3
Westcliffe: *** 99.3 PA: add class A

CONNECTICUT:

Hartford: WZMX 93.7 FC to rhythmic oldies
Storrs: WHUS 91.7 inc. to 1028 w (h), 4.4 kW (v), 492 ft, DA, XC: 41-48-50 / 72-15-36
Torrington: WAPJ 88.9 NW, AC/variety

DISTRICT OF COLUMBIA:

Washington: WGAY 99.5 FC to rhythmic oldies (after simulcasting other Jammin' Oldies stations from NYC, Chicago, and LA)

FLORIDA:

Blountstown: WPHK 102.3 QG to 102.7 - A, PG> 6 kW, 328 ft.
Callaway: WMXP 103.5 FC to soft AC "Coast"
Cedar Key: WRGO 102.7 adds Jones oldies (&)
Florida City: WMFL 88.5 NW, AFA Cont. Christian (&)
Key Colony Bch: WKYZ 101.3 NW, Classic rock (&)
Key Largo: WMKL 91.7 NW, AFA cont. Christian (&)
Madison: *NS 91.7 AF
Naples: WTLT 93.5 PC> 6 kW, 328 ft, XC: 26-19-00 / 81-47-13



Orlando: WSHE 100.3 FC to oldies "Cool 100"
Panama City: WLHR 107.9 FC to CHR "Hot 107"
Pensacola: WIRP 88.3 NW, Spanish religion
Plantation Key: WCTH 100.3 FC to WW1 country (&)
Punta Rassa: WCCL 97.7 PC< 5.3 kW, 348 ft, DA
Sebastian: *NS 95.9 PG 25 kW, 148 ft, XG: 27-48-44 / 80-36-29
Springfield: WYOO 101.1 OSA to C3, 25 kW, DA
Tavernier: WKEZ 96.9 CC (ex WIFL), FC to soft AC "Easy" (Key West)
Venice: WCTQ 106.3 QG to 106.5, PG> 13 kW, 584 ft, DA, XG: 27-32-42 / 92-34-27

GEORGIA:

Donaldsonville: WWGF 107.5 LC
Jesup: WBKF 90.5 CC (NS)
Savannah: WLXP 88.1 LC
West Point: WCJM 100.9 PG< 5.8 kW, 328 ft, XG: 32-51-07 / 85-08-14

IDAHO:

Caldwell: KCID 107.1 FC to a/c (Boise)



ILLINOIS:

Alton: KATZ 100.3 FC to urban "The Beat"
Canton: WBDM 101.1 PG 3.3 kW, 449 ft., XG: 40-39-00 / 89-46-46, CL: Gadsford, IL
Columbia: KMJM 104.9 FC to urban AC (St. L.)
Eureka: WEEK 98.5 FC to CHR "The Party"
Morris: WYXX 103.1 PG> 6 kW, DA
Peru: WLRZ 100.9 PG> 3 kW, 328 ft, XG: 41-18-09 / 89-14-11, FC to ABC classic rock (&)
Ramsey: WJLY 88.3 NW, Moody Religion // WTRH
Wheaton: WETN 88.1 PG 250w (circular)

INDIANA:

Lafayette: WAZY 96.5 FC to WW1 a/c (&)
Lebanon: *NS 91.9 AF
Muncie: WERK 104.9 FC to oldies (&) // WLHN
Portland: WPGW 100.9 PC> 4.6 kW
Union City: WJYW 88.9 CC (ex WOEI) "Joy FM"
Vincennes: WATI 89.9 PG> 2.6 kW, 374 ft, XG: 38-41-02 / 87-26-08

IOWA:

Burlington: KDMG 103.1 XC: 40-44-04 / 91-15-15
Burlington: KKMI 93.5 XG: 40-49-11 / 91-07-02, inc. to 305 ft.
Keokuk: KOKX 95.3 PC> 100 kW, 794 ft, C1, XC: 40-24-01 / 91-35-09, PG to 804 ft.
Keokuk: KRNO 96.3 LC, PG< 19 kW, 804 ft.
Oskaloosa: *NS 89.5 AF (U of N. Iowa)

KANSAS:

Arkansas City: KAXR 91.3 PG> 4 kW, 328 ft, XG: 36-52-31 / 96-58-37
Augusta: *** 100.5 PA: add class A
Baxter Sp: KMOQ 107.1 FC to classic hits
Cimarron: *** 92.3 PA: add class A
Concordia: KCKS 95.3 FC to hot AC "Kiss" (&)
Enterprise: KBMP 90.5 CC (NS)
Great Bend: KBDA 89.7 NW, AFA cont. Christian (&)
Independence: *NS 88.5 AF
Lawrence: KJHK 90.7 PC> 2.9 kW, 282 ft.
Oberlin: *NS 91.3 AF (VCY America)
Ottawa: KCHZ 95.7 PC> 100 kW, 981', DA

KENTUCKY:

Bowling Green: WDNS 93.3 FC to classic rock "D93", also adds Jones classic rock (&)
Brownsville: WKLX 100.7 LC
LeRose: WSPS 88.3 NW, variety
Lexington: WLKT 104.5 dec. to 466 ft, ND, XG: 38-04-09 / 84-18-44

Kentucky:

Nicholasville: WLTO 102.5 FC to R&B oldies
"Groovin" (Lexington)

LOUISIANA:

Alexandria: KEDG 106.9 PG 6 kW, 328 ft, XG: 31-18-26 / 92-23-56

Basile: KQIS 102.1 PC> 100 kW, 981 ft, class C1, XG: 30-05-13 / 92-22-54

Soft Rock 102.1

K Q I S - F M

BEST OF THE 90'S, 80'S AND 70'S

Baton Rouge: WXCT 100.7 SG "Tiger Country" (see story)

Hammond: WCAC 103.3 CC (ex WKJN) "Cat Country"

Monroe: KBMQ 88.7 CC (NS)

Oak Grove: KWCL 96.7 PC> 23 kW, 341 ft.

MAINE:

Bangor: W219CC 91.7 NS-50w: KLVC 88.3 CA
Isleboro: WAYD 105.5 LC

MARYLAND:

Fruitland: W206AY 89.1 NS-5w: KAWZ-ID

Midland: *** 99.5 PA: add class A

MICHIGAN:

Ann Arbor: WQKL 107.1 adds Delilah

Iron Mountain: *NS 91.5 AF

Marlette: *NS 89.7 AF

Wyoming: WYCE 88.1 PG> 7 kW (v), 495 ft, DA, B1, XG: 42-54-43 / 85-41-00

MINNESOTA:

Ortonville: KCGN 101.5 FC to cont. Christian // KBHL

Worthington: *NS 88.1 AF (AFA)

MISSISSIPPI:

Belzoni: WGNG 106.3 PG> 8 kW, 456 ft, class C3, XG: 33-18-26 / 92-23-56

Biloxi: *NS 88.1 AF

Corinth: WXRZ 94.3 FC to JRN oldies (&)

Forest: *NS 90.5 AF

Raymond: W214BE 90.7 NS-10w(v): KEFX-ID

MISSOURI:

Amazonia: *** 102.5 PA: add class A

Bonner: K212DE 90.3 NS-2w: KEFX-ID

Branson: KOZO 89.7 NW, religion

Cedar Hill: KNLH 89.5 NW, religion // KNLG

Hannibal: KJIR 91.7 CC (NS)

Kalispell: K201EY 88.1 NS-10w(v), DA: KEFX

Kennett: KTMO 98.9 PA: to class C, Keiser, AR

Missoula: K204DF 88.7 NS-2w: KAWZ-ID

Osage Bch: KRMS 93.5 OSA to C2, 39 kW, 551 ft., XG: 38-09-52 / 92-36-12

Scott City: KGKS 93.9 OSA to C3, 16.5 kW, 407 ft, DA, XG: 37-21-34 / 89-37-16

St. Charles: KCLC 89.1 PG> 35 kW (cir), 226 ft, DA, XG: 38-47-05 / 90-30-05

Troy: KZMM 100.7 FC to sports // KFNS 590

"Fans 590"

MONTANA:

Babb: *** 94.5 PA: add class C3

Big Sky: KBFN 104.5 FC to adult alternative

Butte: KAPC 91.3 NW, info, variety // KUFM

Butte: *NS 90.5 AF (AFA)

Drummond: *** 101.5 PA: add class C

Evergreen: *** 93.9 PA: add class A

Missoula: KMZL 91.1 inc. to 2053 ft.

Victor: *** 101.7 PA: add class C3

NEBRASKA:

Grand Island: *NS 88.3 AF (AFA)

McCook: KICX 96.1 OSA to class C, 100 kW, 984 ft, XG: 40-29-16 / 100-39-34

Minatare: *** 106.9 PA: add class A

Plattsmouth: KOTD 106.9 PG> 25 kW, class C3

XG: 41-09-18 / 95-45-42

NEVADA:

Caliente: *** 94.5 PA: add class C1

Ely: KHIX 96.7 GA: to Carlin, NV, class C

Jackpot: *NS 91.3 AF

Las Vegas: KISF 103.5 FC to regional Mexican "La Nueva" // KLSQ, may debut with a Ranchera format soon

Logandale: *** 106.1 PA: add class C1

Wells: *** 103.9 PA: add class C1

NEW HAMPSHIRE:

Lancaster: WXXS 102.3 OSA to C3, 1.5 kW, 964 ft, XG: 44-23-39 / 71-39-20

NEW JERSEY:

Canton: WJKY 101.7 FC to urban AC

Egg Harbor: WEMG 104.9, SI, will RA soon with Spanish CHR // WURD, CC (ex WRDR)

NEW MEXICO:

Eagle Nest: *** 104.7 PA: add class C2

Magdalena: *** 95.9 PA: add class C2

Raton: KGOY 96.5 CC (NS)

Shiprock: *** 106.5 PA: add class C1

Santa Fe: KRZN 105.1 FC to CHR "Channel 105.1"

Shiprock: *** 106.5 PA: add class C1

Socorro: *** 102.1 PA: add class C2

Smooth Jazz 105.1
THE HORIZON

NEW YORK:

Big Flats: WGMM 97.7 PC< 610w, 722 ft, DA, XG: 42-08-31 / 77-04-40

Coming: WCBA 98.7 PC< 1.2 kW, 722 ft, DA, XG: 42-08-31 / 77-04-40

Dundee: WFLR 95.9 adds JRN soft AC (&)

Jewett: WRIP 97.9 PG 580w, 1056 ft, DA, XG: 42-17-06 / 74-15-52

Lake Ronkonkoma: WSHR 91.9 PC> 6 kW (cir), 177 ft, XG: 40-50-10 / 73-05-59

Marcellus: W208AQ 89.5 NS-10w(v): WXXC

Mechanicville: WABT 104.5 CC (ex WXLE)

"Albany's Beat"

Oswego: WOLF 96.7 FC to Disney / Children's // WOLF 1490 (Syracuse)

Patterson: WAXB 105.5 adds ABC oldies (&)

Plattsburgh: WKOL 105.1 adds ABC oldies (&)

New York:

S.Bristol: WMAX 107.3 FC to rhythmic oldies
"Jammin Oldies 107" (Rochester)

Syracuse: WMHR 102.9 XC: 42-58-01 / 76-12-00

Woodstock: WDST 100.1 PC> 3 kW, 315 ft, XC: 41-59-24 / 74-01-07

NORTH CAROLINA:

Asheboro: WTJY 89.5 CC (ex WWMO)

Belhaven: WANJ 101.1 XC: 35-18-18 / 76-45-45

Buxton: *NS 90.5 AF

Calabash: WYNA 104.9 PC 23.5 kW, 338 ft, DA, XG: 33-49-19 / 78-46-18

Charlotte: WSOC 103.7 inc. to 1348 ft, XG: 35-15-06 / 80-41-12

Hatteras: WYND 97.1 FC to soft AC "The Wind"

High Point: WHSL 100.3 adds John Boy & Billy

Jacksonville: WXQR 105.5 adds Lex & Terry

Jacksonville: WQSL 92.3 adds Bob & Sheri

Kinston: WZBR 97.7 FC to beach music // WNBR

Lexington: W216BI 91.1 NS-27w: WPIR 90.9 VA

COUNTRY BEAR  **WNBR/FM 94.1 WZBR/FM 97.7 WBSY/FM 104.7**

Classic Country, all the time.

Manteo: *NS 90.9 AF

New Bern: WNBR 94.1 FC to beach "Sunny Beach Network"

Old Fort: WMXF 104.3 CX CP for 6 kW, 171 ft, DA, XG: 35-37-44 / 82-20-46

Raeford: *NS 88.7 AF (AFA)

Rose Hill: WBSY 104.7 FC to beach // WNBR

Fort Totten: KABU 90.7 NW, native American & variety

Williston: K213CW 90.5 NS-92w: KLOV-FM

NORTH DAKOTA:

Dickinson: KZRZ 92.1 CC (ex KRRB), FC to hot AC "The Point" (&)

Fort Totten: KABU 90.7 NW, native American & variety

Williston: K213CW 90.5 NS-92w: KLOV-FM

OHIO:

Akron: WAPS 91.3 drops jazz

Beach City: WOFN 88.7 change directional array

Cleveland: WENZ 107.9 FC to urban "Kiss"

Fairfield: WVAE 94.9 FC to rhythmic oldies "Mojo" (Cincinnati)

Middleport: WMPO 92.1 FC to CHR

N. Baltimore: WIMJ 107.7 FC to oldies "Magic 107.7"

Youngstown: WYTN 91.7 PG> 1.8 kW, 613 ft, DA, XG: 41-03-24 / 80-38-44

OKLAHOMA:

Woodward: KJOV 90.7 NW, cont. Christian

OREGON:

Altamont: KRAT 97.7 QC from 101.3, now C1, 22 kW, 1712 ft.

Canyonville: K201EW 88.1 NS-11w: KAWZ-ID

Colton: K216EH 91.1 NS-10w(v): KEFX

Lake Oswego: KKJZ 106.7 dec. to 1157 ft, XC: 45-30-57 / 122-43-52

Redmond: KLRR 101.7 QC from 107.5

PENNSYLVANIA:

Ephrata: WIOV 105.1 inc. to 702 feet, XG: 40-10-27 / 76-09-31, inc. to 699 ft.

Forest City: *NS 100.1 750w, 935', DA

Hazleton: WXBE 97.9 CC (ex WZMT) "The Bear"

Oil City: WOYL 98.5 adds ABC country (&)

Red Lion: WSOX 96.1 PG< 13.5 kW, 951', DA

St. Mary's: WPKK 97.5 RA with country "Eik Country"

SOUTH CAROLINA:

Columbia: W206AX 89.1 NS-10w: KAWZ-ID

Lexington: WLXC 98.5 adds Tom Joyner

Newberry: WDXZ 106.3 reported SI

SOUTH DAKOTA:

Wessington Sps: KGGK 98.3 NW, oldies "Cool 98"

TENNESSEE:

Dickson: WNRZ 91.5 FC to Skylight c. Christian (&)

Henry: WMUF 104.7 NW, country (&)

Johnsonville: *NS 89.7 AF

Lawrenceburg: WAWI 89.7 LC

Maryville: WTXM 95.7 CC (ex WGAP) "Mix 95.7"

Nashville: WRVU 91.1 PC< 10 kW, 695 ft.

Selmer: *NS 90.5 AF (AFA)

Waverly: *NS 90.9 AF

TEXAS:

Amarillo: KBZD 99.7 FC to blues

Bushland: K212DG 90.3 NS-90w, DA: KEFX-ID

Byrne: *NS 88.5 AF

Columbus: KULM 98.3 adds ABC country (&)

Decatur: KRNB 105.7 dec. to 1332 ft.

Denison: KIKM 101.7 PG> 92 kW, 2034 ft, class C, XG: 33-26-13 / 97-29-05, CL: Azle, TX, reported SI

Dumas: KMRE 95.3 FC to oldies (&)

Groveton: *** 98.1 PA: add class A

Henderson: KDVE 100.3 QC from 99.9 on an STA, still pending is a 100.3 PG< 2350w, 535 ft, class A, CL: Tatum, TX

Howe: KHYI 95.3 SG "95.3 The Range"

Jacksboro: KJKB 101.7 reported SI

Littlefield: KAIQ 95.5 PG< 7 kW, 108 ft, XG: 33-55-30 / 102-20-15

Lovelady: *** 104.3 PA: add class C3

Overton: KPXI 100.7 RA with oldies (&) "Cool"

Pearsall: KWVG 95.3 PG< 2.8 kW, 138 ft, XG: 28-50-07 / 99-06-24

Plainview: KHDY 106.9 LC

Raymondville: KILM 102.1 CC (ex KSOX) "La Mejor"

San Diego: KUKA 105.9 PC> 10 kW, 413 ft, ND, class C3, XG: 27-38-59 / 98-07-44

Tyler: KTYL 93.1 FC to rhythmic oldies

 **FM 90**
Texas New Music Source
KACY - Amarillo

UTAH:

Brigham City: KRAR 106.9 FC to oldies // KXOL
 Castle Dale: *** 95.3 PA: add class C3
 Huntington: *** 107.1 PA: add class C2
 Hurricane: *** 102.9 PA: add class C3
 Kanarrville: *** 101.5 PA: add class C2
 Logan: KUSR 89.5 NW, info & class // KUSU
 Mona: *** 92.9 PA: add class A
 Monticello: *** 106.1 PA: add class C1
 Roosevelt: KXRQ 94.3 NW, classic rock
 Wellington: *** 92.1 PA: add class C3

VERMONT:

Brandon: WEXP 101.5 LC
 Hague: WRRO 93.7 CC (ex WWFY) "Rock and Roll Oldies"
 St. Johnsbury: WVPA 88.5 CC (ex WBJU), NW, into and classical // WVPS "Vermont Public Radio"
 Springfield: WCFR 93.5 PG< 1450w, 472 feet, XG: 43-18-55 / 72-27-37
 White River Jct: WWSH 95.3 adds WW1 soft AC (&)

VIRGINIA:

Ruckersville: WVSY 101.9 FC to rhythmic oldies (Charlottesville)
 Warrenton: WPLC 94.3 CC (ex WUPP), FC to modern AC (Manassas) "Pulse 94.3"

WASHINGTON:

Centralia: K209DA 89.7 NS-250w: WPCS-FL
 Ellensburg: KCSH 88.9 NW, Lifetalk religion (&)
 Hanford: K204DH 88.7 NS-3w: KAWZ-ID
 Nile: KLRO 88.1 NW, talk and religion
 Omak: KQWS 90.1 LC
 Spokane: KNJY 103.9 FC to classic rock "The Hawk"
 Yakima: KYPL 91.1 NW, cont. Christian // KGTS



WEST VIRGINIA:

Clarksburg: WPDX 104.9 PG> 13 kW, 456 ft, class B1, XG: 39-07-32 / 80-12-10
 Fisher: WQWV 103.7 reported SI (should have returned with Jones A/C in May)
 Petersburg: WAUA 89.5 noted on, as part of the WV Public Radio Network
 Salem: WAJR 103.3 NW, talk and sports // WAJR 1440 (breaks from AM to air Dr. Laura 12 - 3 p.m.)

WISCONSIN:

Eau Claire: WBIZ 100.7 FC to CHR "Z100"
 Evansville: WKPO 105.9 PG> 1.7 kW
 Kewaunee: WAUN 92.7 RA with JRN country (&)
 McFarland: W216BL 91.1 NS-120w(v): WWGN 89.9-IL
 Portage: WDDC 100.1 PC< 3.1 kW, 374 ft.
 Sister Bay: WHDI 89.7 dec. to 499 ft, XG: 45-14-19 / 87-05-27

WYOMING:

Cheyenne: KLEN 106.3 PG> 8.7 kW, 551 ft, class C3, XG: 41-06-03 / 105-00-16

PUERTO RICO:

Ponce: WIOC 105.1 PC< 47 kW, -200 ft.
 San Juan: WZNT 93.7 PG< 32 kW, 1778 ft. XG: 18-16-44 / 65-51-12



CANADA

ALBERTA:

Banff: CKIS-1 ?? wants PG>45w, move 8 km to the NE
 Hinton: *NS 94.5 7.4 w, // C1SN 103.9 AB
 Hinton: *NS 99.3 7.4 w, // CFMI 101.1 BC

MANITOBA:

Churchill: *NS: WJCG-FM relay denied (see story)
 Winnipeg: CJAE 92.9 NW, variety
 Winnipeg: CKUW 95.9 NW, variety, CC (NS)
 Winnipeg: CJUM 101.5 NW, variety

NEWFOUNDLAND:

Gander: *NS applied for
 Grand Falls: *NS applied for, to also serve Roberts Arm

NEW BRUNSWICK:

Grand Sault: CIKX 93.5 NW, hot AC "K-93 FM"
 Moncton: *NS 91.7 23.84 kW temporary station wanted (August 21st to September 7th)

ONTARIO:

Barrie: *NS 100.3 1.8 kW religious station granted, another new FM freq. is being considered
 Campbellford: CKOL 98.7 wants 93.5
 Englehart: *NS 103.1 17 watts wanted (would be rock or country)
 Hamilton: *NS applied for here (no freq.)
 Kirkland Lake: CJKL 560 wants 101.5, 23 kW
 London: *NS 102.3 4.7 kW wanted (applicants include CKSL-1410, CHUM Ltd. For CHR station, and Rogers Ltd. For ac or adult a/c.
 Nepean: *NS 97.1 50 w wanted
 North Bay: *NS 104.9 tourist station wanted, 31w
 Oshawa: *NS 88.3 40 w community station wanted
 Tilsonburg: CKOT 1510 wants 102.3, 4 kW (competes with London applications)

PRINCE EDWARD ISLAND:

Summerside: CJRW 1240 wants 102.1, 50 kW



QUÉBEC:

Montreal: CBME 88.5 wants PG> 16.9 kW
 Quebec: CKIA 96.1 denied 94.3 - 350w
 Rimouski: CJBR 900 wants 89.1, 5.5 kW
 Rimouski: applications for new FM stations are being taken
 Sainte-Foy: CHYZ 94.3 inc. to 239w, XG 575m to the west
 Ste-Anne-de-Baupre: *NS 96.7 124 w, to be // CBV-FM
 Thetford Mines: CKLD 105.5 wants 6 kW

SASKATCHEWAN:

Carrott River: *NS 88.1 13w station applied for



MEXICO

NUEVO LEON:

Monterey: XHITE 94.9 NW, 3 kW, SG "Frecuencia TEC"

PIRATE WATCH:

- **HOUSTON, TEXAS.** The FCC shut down "Radio Free Montrose", on 94.9 in this city. This pirate had received previous warnings, but continued to operate. No other details are available
- **GRAND RAPIDS, MICHIGAN.** The FCC shut down yet another pirate here, this time on 93.1. No other information was available, other than that the operator had received previous warnings.
- **Another alternative for the recent Lower Power FM proposals has been presented:** open up part of the FM band ABOVE 107.9 Mhz for low power operations. Some air traffic navigation services in that band would have to be moved elsewhere. No word yet on how seriously this proposal will be taken, nor has there been any decision on the other proposals mentioned here and elsewhere.
- **Tom Bryant sent the information on the format change in Dickinson, North Dakota (KRRB 92.1 to KZRZ).** If you're interested in more information on that change, visit http://www.ndonline.com/TribWebPage/apr1999/413_99964244.html
- **Chip Kelley sends information about slogan changes in Baton Rouge.** For several years now, WXCT 100.7 in that town has been "Cat Country". Well, a different ownership group, Citadel, owns the nationwide rights to that popular slogan. They also own cross-town

WKJN 103.3. Citadel forced WXCT to stop using the slogan, hence WXCT is now "Tiger Country". They have also changed 103.3 to WCAC, "Cat Country", and are going all out to defeat both WXCT and WYNK 101.5, in an attempt to become the top rated country station in Baton Rouge.



CAT COUNTRY 100.7

- **Churchill, Manitoba:** Earlier this year, Mr. Cyril Paul Freudland applied to the CRTC to air a relay of WJCG-FM (Monee, Illinois) in this town. This would have been very out of the ordinary, since the CRTC usually does not allow translators of foreign stations not directly receivable. Freudland argued that since the local cable system carried US programs received via satellite, he should be able to also do so over the air. Freudland also noted that since there are only two local radio stations, his translator would add variety to the local radio dial. The CRTC rejected the arguments, noting that the circumstances did not warrant an exception to its rule, and also noting that Churchill already has several local radio signals available.
- **Doug Smith sent in an article from The Tennessee Magazine about small public radio stations in the Volunteer State.** The article focuses on WCPI, 91.3 in McMinnville, a small public radio station which runs quite a bit of local programming. Virtually all of the on-air staff at this station were local volunteers in this tight-knit community. The station features a wide variety from these volunteers, from a hunting and fishing show, to readings from the local newspaper, to opera and classical music programs, also hosted by locals. "There's a strong interest in opera and classical music wherever you live", says Bill Zechman, a McMinnville insurance agent who hosts a classical music program called "Sunday Showcase". "You don't have to live in a metropolitan area to enjoy good music. It's

wonderful that we've gone from having to tune into a faraway radio station to hear opera to be being able to tune in right here." The station currently cannot afford NPR affiliation (several thousand dollars), but hopes to change that in the future. WCPI also wishes to increase the station's power to reach beyond Warren County.

Middle Tennessee State, Mufreesboro, WPLN 90.3 Nashville, and WRVU 91.1 Vanderbilt University, Nashville.

• **Bill Eckberg** writes us with some important news about an article he is going to have published in *Popular Communications* (which can be found in most bookstores). I've seen a preview of the article, and it's great! It's an in-depth discussion of TV Dxing, the club, and Bill's 44 years in the hobby. It should also feature many interesting photos, and yes, even Bill's famous 1991 unID with the "Chicken Head Test Pattern" (A correspondence William received from someone at the magazine suggests it could have been El Salvador, read the article for more information). We are also very appreciative of Bill's promotion of WTFDA in the article! Look for it in the June or July issue, which should be on the newsstand right now!



The current power is 1,000 watts. For more information on WCPI, write WCPI-FM, 110 S. Court Square, McMinnville, TN 37110, or call (931) 506-9274. The article mentions other Tennessee public radio stations with a local flavor: WUTC 88.1 (University of Tennessee at Chattanooga), WDVX 89.9 Clinton-Knoxville, WSMC 90.5 Collegedale, WETS 89.5, East



Listener Supported, Volunteer Radio For Memphis & the Mid-South

Nashville Public Radio 90.3

WPLN-FM 90.3 Nashville and WIIRS-FM 91.7 Cookeville
Tennessee State-Johnson City, WUOT 91.9 University of Tennessee at Knoxville, WHRS 91.7 Cookeville, WEVL 89.9 Memphis, WKNO 91.1 Memphis (also on WKNP 90.1 Jackson, WKNQ 90.7 Dyersburg, and WKNA 88.9



CLASSIC RADIO

Senatobia, Miss.), WMOT 89.5 Middle Tennessee State, Mufreesboro, WMTS 88.3

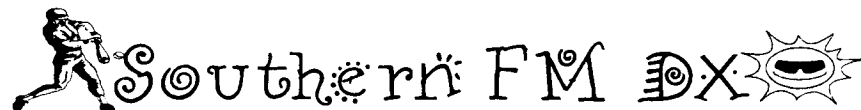

John Zondlo - 4009 Driftwood Circle-Yukon, OK 73099

E-mail: Jpzondlo@aol.com Deadline: 10th

For DXers in AL, AR, AZ, CA, CO, DE, DC, FL, GA, HI, KS, KY, LA, MD, MS, NC, NV, OK, TN, TX, UT, WV and Mexico

JUNE 1999



John Tudenham WOJRP
2824 Missouri
Joplin, MO 64804-2755
jotud@juno.com CDT

Technics ST-G50 tuner, big Radio Shack VHF-TV antenna at 15'

3/28 Tr (CST)
1700 KPOW 97.1 MO Lamonte, ID, "Power 97," ads for Sedalia MO

4/10 Tr
2000 KINZ 94.3 KS Humboldt, ID, "Classic Hits 94.3," fair signal in KAMO null

4/27 Tr
2330 KGNN 90.3 MO Cuba, dual ID with KGNV in Sullivan MO, rel

4/21 Tr
0823 KXOQT 104.3 MO Kennett, "104.3 The Quake, o
0837 WJDD 101.3 MS Meridian, "Q101," local ads 286
4/22 Tr
0830 WMJJ 96.5 AL Birmingham, local ads 203
5/9 gw
2106 KEIN 107.9 AR Jonesboro, "K-Fine," local WCVC off 208

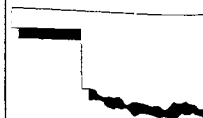

Luke Steele
437902 E 278 Rd
Vinita, OK 74301
(918) 256-8786
CDT

Craig stereo entertainment system (analog) and TV wire indoor antenna (4/20) and DX-390 w/whip antenna (4/21).

Eric Bueneman

NOUIH - 631 Coachway Lane - Hazelwood, MO 63042-1347 - (314) 839-9751 (prepaid only) - NOUIHEric@aol.com, EricB631@juno.com - http://members.aol.com/nouiheric/k-index.html CDT

Realistic STA-90, Archer VU-210XR antenna with Archerotor at 33' AGL. Miles/kilometers

May 3 Gw
0351 WJLY 88.3 IL Ramsey, light CCM, SRN nx, legal ID, x-93.3 55/89
0505 KZMM 100.7 MO Troy, ESPN sportstalk, "Fans 590" /KFNS 590 45/72

A pair of notable changes here. WJLY is now on 88.3, having moved the calls from 93.3. The overnight programming is still simulcast with WTRH 93.3. KZMM 100.7 has dropped its classic country format in favor of an all sports format, simulcasting KFNS 590 Wood River IL. A call change on 100.7 to KFNS-FM is pending. 73, Eric (NOUIH)

4/20 Tr
2228 WGGZ 98.1 LA Baton Rouge, "Eagle 98.1"
2230 WLSS 102.5 LA Baton Rouge, "Loose 102"
2233 KUMX 104.1 LA Houma, "All Hit Music Mix 104.1"
2240 WXCT 100.7 LA Baton Rouge, "Tiger Country 100.7"
2300 KKND 106.7 LA Port Sulphur, "The End"
2340 WEMX 94.1 LA Kentwood, "Max 94.1"
4/21 Tr
0734 KVIL 103.7 TX Highland Park
0736 KDMX 102.9 TX Dallas, "Mix 102-9"
0737 KTXQ 102.1 TX Fort Worth, "Magic 102"
0741 KNOE 101.9 LA Monroe, "FM 102"
0742 WRR 101.1 TX Dallas, c
0744 KLUV 98.7 TX Dallas, o
0810 KQID 93.1 LA Alexandria, "60 degrees in Alexandria at Q-93"
0813 KCBI 90.9 TX Dallas, rel talk
0814 WMAU 88.9 MS Bude, NPR
0820 WEZB 97.1 LA New Orleans, "B 97.1," traffic rpt ment Kenner and Metairie



Doug Smith

1385 Old Clarksville Pike - Pleasant View, TN 37146-8098
w9wi@bellsouth.net CDT



FROM THE EDITOR

Good turnout, tho conditions have been pretty bleak thru the first part of May. Hopefully we'll get quite a few good skip openings this month. See y'all in July!

NORTHERN FM DX

JUNE 1999

DEADLINE : The 5th of the month before publication
LOG CUTOFF: 4 months from postmark
COLUMN REPORTING AREA: See map to the right
 (also includes Europe & Asia)

EDITOR: GREG CONIGLIO
 90 SLATE CREEK DRIVE APT. #3
 CHEEKTOWAGA, NEW YORK 14227
 E-MAIL: coniglio@localnet.com
 WEB: <http://www.geocities.com/~wgrc>

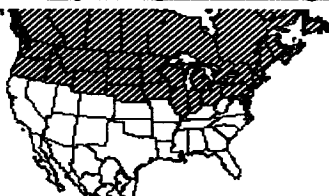

Another small column. Some interesting tropo reported this time around by Dave Nieman, who also caught some early season FM skip. As of this deadline, there are signs of the skip season starting, so hopefully they'll be some DX to report soon. If you hear skip, or some tropo, why not let us all know about it, by reporting to your WTFDA DX column!

DAVE NIEMAN · HO STA GEH ROAD · ROCK CITY NEW YORK 14749
 Equipment: Carver TX-11 tuner; IF filter modified, Pioneer SX 650 receiver. Channel Master model 4408 (Stereo Probe 9) at 59 feet AGL on a Alliance HD-73 rotor. Winegard FT-7600 variable FM trap for 95.7MHz, Belden RG-11/u coax feed.
 New loggings are underlined.

MARCH 1999 DX

27 tropo & Groundwave
 0829 WASB 105.5 NY Brockport, ID, g\$ 85
 0900 WZKZ 101.9 NY Alfred, "KZ-country" + ID, IDs with Wellsville & Hornell, k\$ 35

MARCH 1999 DX

28 tropo
 1243 WSSN 102.3 WV Weston, now "The Planet-102 dot 3", r\$ 229

APRIL 1999 DX

18 tropo
 1000 W214BB 90.7 NY Lockport, WCOU 88.3 g\$ 79

APRIL 1999 DX

24 tropo
 0218 WQBE 97.5 WV Charleston, call, k\$ 302



1611 WALK 97.5 NY Patchogue, call, mr\$ 292
 25 tropo
 0900 WREQ 96.9 PA Ridgebury, "Q-96.6" + ID, gm\$, over WGRF Buffalo 86

MAY 1999 DX

1 tropo
 0230 CKBY 105.3 ON Ottawa, call, k\$ WKPQ Hornell off this morning 273

Y105

Young Country

MAY 1999 DX

1 tropo continued
 0237 W287AE 105.3 NY Buffalo, k\$, WNUC 107.7 64

2 tropo & Meteorscatter

1059 CBCE 97.5 ON Little Current, t mono "CBC Radio" 322
 1121 KBOE 104.9 IA Oskaloosa, call, \$ 731

8 tropo

0200 CHOW 91.7 ON Welland, call, k\$ new-to-the-air testing 76
 0728 WPKK 97.5 PA St. Marys, ID, k\$ "Elk Country", format change 29

9 tropo

1200 WAUA 89.5 WV Petersburg, Network ID, t\$, "West Virginia Public Radio" 198

15 e-skip

1219 KJIC 90.5 TX Santa Fe, call, g\$ 1265

16 tropo

1300 WELD 101.7 WV Petersburg, ID, g\$ 211
 Sunday programming??

NORTHERN FM DX

JUNE 1999

RALPH STROBEL - 106 E. DAVIDSON STREET - MUNCIE, INDIANA 47303
 Equipment: McIntosh MR-78 FM Tuner with two CM Stereo Probe 9 antennas and rotors at 38 and 32 feet above ground separated at 23 feet, with use of Bolin phase box. All stations in \$ unless noted mono. *Denotes use of phase box.

October 1998 (COT)

8 MS
 ?? KLIR 101.1 NE Columbus 633
 21 MS
 0052 KONE 101.1 TX Lubbock 1018
 ?? KRMD 101.1 LA Shreveport 706
 28 tr
 0100*WRHL 102.3 IL Rochelle, rm 227
 (o/WLHM 102.3 IN Logansport) 64
 0115 WMMM 105.5 WI Verona-Madison, r 289
 "Triple-M"
 0250 WGLR 97.7 WI Lancaster, k 332
 November 1998 (EST)

7 tr
 2100*WAHY 107.9 KY Midway-Lexington, 145
 rs, "The Beat"
 (o/WTPI 107.9 IN Indy) 50
 15 MS
 ?? KWOX 101.1 OK Woodward 803
 ?? KOSI 101.1 CO Denver 1040
 ?? KOSI 101.1 CO Denver 1040

16 tr
 0845 KRMD 101.1 LA Shreveport, k 706
 0850 KVKI 96.5 LA Shreveport, rm, ID 706

17 MS
 0050 KJMS 101.1 TN Memphis 432
 0159 WRR 101.1 TX Dallas 815
 0248 KRFX 103.5 CO Denver, previous Es 1040

0512 KLAA 103.5 LA Tioga-Alexandria 725

December 1998

2 tr
 0200*WQSH 93.1 IN Clarksville, mr, 133
 (o/WNAP 93.1 IN Indy) "She-93-1" 50

13 MS
 ?? KOSI 101.1 CO Denver 1040
 2200 WRR 101.1 TX Dallas 815
 ?? KRMD 101.1 LA Shreveport 706

16 MS
 ?? WJIS 88.1 FL Bradenton 892
 (With mx, a 5 min. 15 sec. burst)

METEOR SCATTER LOGGINGS:

0/08 KLIR "...with Nebraska news..."
 0/11 KONE "...Oasis-101.1..."
 KRMD "...KRMD-FM is..."
 N/15 KWOX "...WOX..."
 KOSI "...KOSI. We sound great..."
 KOSI "...of the cozy top twenty countdown brought to you by..."
 N/17 KJMS "...of today's smooth hits... Smooth 101.1..."
 WRR "...on WRR Dallas-FW..."
 KRFX "...Two for Tuesday on 103-5 the Fox..."
 KLAA "...KLAA..."
 D/13 KOSI "...traffic in town...the cozy airborne 101. And great songs to pick you up and get you goin'..."

December 1998 (cont'd)

31 tr
 0354 WCYO 100.7 KY Irvine-Richmond, 177
 k, "Coyote Country"

January 1999

3 MS
 0344 KPXI 100.7 TX Mt. Pleasant, k 720
 (verified by phone)

7 tr
 1500*WMCI 101.3 IL Neoga-Charleston- 172
 Mattoon, k
 (o/WFMG 101.3 IN Richmond) 35

29 trs
 2215*WRGX 88.5 WI Sturgeon Bay, gr 337
 "Resurrection Radio-We're Generation X"

30 tr (88.3 IN Fort Wayne WLAB ID)
 0300*W203AU 88.5 IN Warsaw, gr, 27w 77
 (o/WMUB 88.5 OH Oxford) 58

February 1999
 26 tr (88.3 IN Fort Wayne WLAB ID)
 2200 W209BA 89.7 IN Kendallville, gr 88
 (WTVR 89.7 IN Upland, off air)

March 1999
 15 gw
 1800 WARU 98.5 IN Peru, rp, 53
 ex--98.3 s/off 0000

April 1999
 3 tr
 1700 WJLY 88.3 IL Ramsey, g mono 211

6 tr
 0100 WGDE 91.9 OH Defiance, c, 93
 //90.7 90.9 & 91.3

2200 WSTL 92.1 KY Carlisle-Lex., gr 148
 (WBST 92.1 IN Muncie, off air) 4

8 MS
 2142 KBHP 101.1 MN Bemidji 692

15 MS
 0124 KRMD 101.1 LA Shreveport 706
 19 MS
 ?? KRMD 101.1 LA Shreveport 706
 (New Underlined) (All \$ except 88.3 WJLY)

The snow was all gone from the mountain this (4/18) weekend. Also noticing 97.5 MHz open with WPKK St. Marys PA off. I had one unIDed country station with "NASA Car Country" beam heading of 210°. I didn't note the exact time but I think it was before noon on Sunday. Also heard were Martinsburg WV, Akron OH, London ON, Watertown NY and Trenton NJ. WPKK 97.5 St. Marys PA was back on with a format change after several weeks of silence. Nice to see the skip on 5/15 although it was a brief opening.

I usually don't count a non-ID as a new station, but my phone call to 100.7 KPXI Mt. Pleasant, TX convinced me it could only be them. The woman I spoke to recognized the DJ's voice immediately and said he worked from midnight to 6 AM. Many long bursts on 11/17 and 1/3, but few ID's. We can only hope for some skip soon!

WESTERN TV-DX

June 1999

Dennis Park Smith, 3703 Dixon Street, Santa Barbara, CA 93105-2419 (805)687-7803

This report is for March and April 1999.

Mar 1-2: Variably poor (Mild, breezes)
 Mar 3-5am: None (Mild, breezes)
 Mar 5 aft: Briefly poor (Intermittent wind & weather)
 Mar 5 eve-12am: None fronts; rain not this far south until March 9
 Mar 12 aft-13: Variably poor-fair (Rain Mar 15-16;
 Mar 14-18: None cold, snow in mountains)
 Mar 19am: Very poor
 Mar 19 aft-25: None (Rain Mar 19 eve-20)
 Mar 26am: Poor (Wind & occasional rain;
 Mar 26eve-28: None all the way through April 11)
 Mar 29am: Poor
 Mar 29 eve through Apr 10am: None
 Apr 10 eve: Very poor
 Apr 11-14: None (Warmer)
 Apr 15: Fair
 Apr 16-17: Very poor
 Apr 18-19: Variably fair, deteriorating
 Apr 20: Very poor, deteriorating (Windy)
 Apr 21-30: None (Unsettled & windy, colder)

For some time in these reports, I have noted coastal and tropo conditions without mentioning actual stations. Here is a list of stations received in Santa Barbara, including locals up to 15 mi/25 km, regulars up to 90 mi/145 km, and tropo DX up to 200 mi/315 km. All were noted in different locations in a '10 mi/ 15 km oval' in S.B./Goleta area at home on indoor antennas and on car radio and portable TVs at elevations of sea level to approx. 250 ft. Any station not on this lists will be specifically mentioned in future Santa Barbara reports. Listing includes channel, call, city, any non-ID, network, and approx. mi/km distance.

2	KCBS	Los Angeles	"CBS 2" CBS	90/145
3	KEYT	Santa Barbara	ABC	15/25
4	KNBC	Los Angeles	"NBC 4" NBC	90/145
5	KTLA	Los Angeles	WB	90/145
6	KSBY	San Luis Obispo	NBC	75/115
6	XETV	Tijuana/San Diego	"Fox 6" English	200/315
7	KABC	Los Angeles	"ABC 7" AGBC	90/145
8	KFMB	San Diego	CBS	175/280
9	KCAL	Los Angeles	"K-Cal 9"	90/145
10	KGTV	San Diego	ABC	175/280
11	KTTV	Los Angeles	"Fox 11" Fox	90/145
12	KCOY	Santa Maria	"CBS 12" CBS	50/80
12	XEWT	Tijuana		200/315
13	KCOP	Los Angeles	UPN	90/145
15	K15DB	Santa Barbara	translator KTBN-40	4/7
15	KPBS	San Diego	PBS	185/295
19	????	Santa Barbara	temporarily Mas Musica TeVe but now 24-hr color bars (see note #1)	

Victor Frank
 12450 Skyline Blvd.
 Woodside, CA 94062-4554
 e-mail frank@horizon.sri.com
 (650)851-7031

21	XHTIT	Tijuana	XHIMT-7 network	200/315
22	KWHY	Los Angeles	Business/Spanish/overnight Shop at Home	90/145
24	KKFX-LP	Santa Barbara	"Fox 11" Fox/overnight ACN shopping (America Collectibles Network)	4/7
27	XHJK	Tijuana	XHDF-13 network	200/315
28	KCET	Los Angeles	PBS/overnight ARTS (Classical Arts Showcase)	90/145
33	XHAS	Tijuana	Telemundo	200/315
34	KMEX	Los Angeles	Univision (Spanish)	90/145
39	KNSD	San Diego	"NBC 7/39" NBC	185/295
40	KTBN	Santa Ana/Los Angeles	TBN	90/145
43	KTSB-LP	Santa Barbara	PAX	4/7
44	K44DT	Simi Valley	translator KJLA-57	50/80
45	K45DU	Ventura	translator KTBN-40 Note #3	25/40
46	KHSC	Ontario/Los Angeles	HSN (Home Shopping Network)	90/145
49	K49EK	Santa Barbara	The University Network (preacher Gene Scott) See note #2	4/7
51	KUSI	San Diego	UPN	185/295
52	KVEA	Corona/Los Angeles	Telemundo (Spanish)	90/145
55	K55AP	Santa Barbara	West/Goleta/Santa Ynez Valley translator KCET-28	15/25
57	XHUAA	Tijuana	XEW-2 network	200/315
58	KLCS	Los Angeles	educational and PBS	90/145
59	K59CD	Santa Barbara	translator KSBY-6	4/7
61	K61AI	Santa Barbara	translator KCET-28	4/7
63	KADY	Ventura/Oxnard	UPN/overnight Shop at Home	50/80
65	KWHY-LP	Santa Barbara	translator KWHY-22	4/7
69	KSWB	San Diego	WB	185/295

Notes:

1. First seen Nov. 6, new Ch. 19 was thought be Ventura area because of weak signal, but is actually in Santa Barbara with insufficient or misdirected power.
2. New K49EK had been seen testing since Feb. 12 and started programs Easter, Apr. 4.
3. K44DT and K45DU were seen for the first time in Santa Barbara on April 30, on a hill with portable. They may be regular & consistent and just missed them before.

Jeff Kadet, K1MOD, Box 20, Macomb, IL 61455

Equipment: Icom R7100 w/video adapter or 13" Zenith color TV; 7 foot screened Channel Master UHF dish at 85 feet w/RDX Labs pre-amp, .500 hardline.

1 April 1999 00:45 CST

Houston area UHF TV in here now. [The opening this AM got as far sw as Abilene (KTAB-32 as good as it ever gets), Galveston-22, Rosenberg-45, plus the other Houston area U's]

Western TV DX

Pat Dyer, WA5IYX, 5315 Silvertip Drive, San Antonio, TX 78228-2744

Items a bit beyond the "normal" tropo extension range here:

April 11, 1999 (tropo)	UTC
0856 WWWB	32 FL Lakeland
0900 WTSP	10 FL St. Petersburg
	WTVT 13 FL Tampa
0915 WPLG	10 FL Miami (colorbar test pattern)

Cold front moved thru soon on Saturday disrupting most of this.

Jeff Kruszka, 5024 S. Braxton Ave., Baton Rouge, LA 70817

March 1999	CST
10 tr 2240	WFTS 28FL 550
	WBHS 50FL 550
16 tr 2215	KXAN 36TX 395
	KRRT 35TX 475
	2239 KEYE 42TX 395

April 1999	CST/CDT
1 tr 2319	WZTV 17TN Montel 465
	2324 WZDX 54AL 400
	2327 WSW5 66AL Newlywed Game 370
	2330 WCTE 22TN signoff 510
	2333 WNPX 28TN Pax//49 510
	2352 WUXP 30TN Cheers, 'UPN Nashville' 465
	2358 WHIQ 25AL //36, 41 400
2 tr 0007	WAFF 48AL NBC 400
	0046 WNAB 58TN 465

		unid color bars per D. Smith	465
	0055	WJFB 66TN Shop at Home	485
	0059	WHTN 39TN "Nashville39.com"	460
	0145	WBRC 6AL ID	330
	0148	WCIQ 7AL APT //42	375
7 tr 2315	XHAB 7 TA		505
8 tr 0705	XHREY 12TA		535
	KXAM 14TX Today Show		445
	KXAN 36TX		395
	1939 XHAB 7 TA solid!		505
	2009 XHFOX 17TA		535

9 tr 2100	XHMOYt22NL SS		500
	2102 KVEO 23TX		500
	2107 KEDT 16TX		425
	2126 WRBW 65FL Florida ads		600
	2130 WKCF 18FL WB 18		575
	2200 WXPX 66FL ID		560
	WBSV 62FL ID		575
	2204 WBSF 43FL Home shopping		655
	2215 KWEX 41TX		445
	KEYE 42TX		395
	2224 WFTX 36FL "Fox 4," CCI from KXAN!		620
	2227 WWSB 40FL logo, Devil Rays highlights		555
	2232 WTVK 46FL Newsradio heard, over local		645
	2235 unid 51 SS to S.E., briefly		

2239	W60BK	60FL TBN	550
2253	WTVX	34FL Mad About You	690
	WFLX	29FL Cheers	720
2312	WKMGt	6 FL CBS	
2317	WJWB	17FL Extra	560
2330	WGCU	30FL	620
2340	WPXP	67FL Pax // 49, 66	720
2350	WZVN	26FL Lee Co. mention	645
10 tr 0008	WRXY	49FL see Note 1	625
20 tr 2100	KSAT	12TX	445
	2102 KXAN	36TX	395
	2103 KWEX	41TX	445
	KEYE	42TX	395
	KVDA	60TX	445
	2216 KENS	5 TX floating	445
	2219 KVUE	24TX	395
	2246 KAUT	43OK UPN 43	505
	2304 KAKW	62TX Cops	390
	2314 KPXD	68TX Pax	385
	2315 KDTX	58TX TBN	365
	2322 WJEB	59FL TBN to E.	565
	2328 WTEV	47FL UPN 47, 93.3 Planet Radio ad	560

2334	KHSX	49TX	375
	KUVN	23TX	365
21 tr 0710	WFSU	11FL Barney	405
	0714 WWSB	40FL ABC	555
	WJSP	28GA GPTV	390
	2323 WLTZ	38GA NBC	390
	2332 WSW5	66AL ID	370
	2337 WPGA	58GA ABC, Judge Mills	460
23 tr 2324	KXAN	36TXNBC	395
	KEDT	16TX	425
25 tr 0059	K46DG	46LA see Note 2	55
28 tr 0715	KVEO	23TX	500
	KMBH	60TX ID'ed color bars	495

Note 1 - "America's Prayer Meeting" and phone number floating over always strong WPXL. Confirmed with help from Fernando Garcia.

Note 2 - One of the few LA stations I still hadn't gotten. This one's difficult through local "the Box" LPTV K46CR. I see CCI a lot, but I can't ever get any sound. This night, the Box was showing a black screen for a long time, and I was able to see floaters of programming, which I paralleled to the KLAF outlet on ch. 62. Plus I even caught an ID at 0100!

Danny Oglethorpe, P.O. Box 6688, Shreveport, LA 71136-6688

Tropo: No relogs under 400 miles; no LPTV relogs under 200 miles.

Es: Only the most productive day of each week.

March 1999	UTC	
1 tr 1105	Valley 7, 9, 17	503-513 miles
	Went to bed.	
tr 1300	Valley 5, 14, 23	

Western TV DX D. Oglethorpe's report cont'd

2 Es	1720	WJBK	2 MI	Detroit	904	
17tr	0500	XERV	9 TA	Reynosa	513	
			unIDs 5, 11	(Azteca 7), 22 (XEQ-9) SS to south; probably Veracruz		
tr	1305	Montgomery	AL 20, 26, 32		436	
		WJTC	44 FL	Pensacola	410	
		WTLH	49 GA	Bainbridge	551	
		WCIQ	7 AL	Mt Cheaha	469	
22tr	0400	Valley 7, 9				
APRIL 1999						
01tr	2050	XERV	9 TA	Reynosa	513	
	2055	XHAB	7 TA	Matamoros	503	
4 tr	2120	K53FV	53 TX	Houston; Valuevision	205	
7 tr	0540	Valley	7, 9, 17, 23			
		1310	KMID	2 TX	Midland	487
8 tr	0335	Valley	4, 5, 7, 9, 17, 23, 44			
		0438	KGNS	8 TX	Laredo	481
9 tr	0255	Valley	4, 5, 7, 9, 17, 23			
		1415	K55GE	55 AR	Little Rock; 3ABN	180
10tr	0255	Valley	5, 7, 9, 23			
		0358	Pensacola	FL 23, 44	410	
		0435	Tampa-St Petersburg	FL 28, 38, 44, 50	740	
			WTVK	46 FL	Naples	841
		0440	WBSF	43 FL	Melbourne	840
		0510	WSPF	30 FL	Fort Myers; PBS	818
		0518	WDFXt	34 GA		
			WUSF	16 FL	Tampa; PBS	740
		0525	WFTX	36 FL	Cape Coral; Fox	818
		0550	Montgomery	AL 20, 32	436	
		0640	Valley 17, 44			
		0705	WYES	12 LA	New Orleans; ID Supered at 0800; local off 274 miles	
0810		WWSB	40 FL	Sarasota; ID card	757	
		WFLX	29 FL	West Palm Beach	912	
15tr	0835	WJTC	44 FL	Pensacola	410	
20tr	1235	WJTC	44 FL	Pensacola	410	
		1340	Valley 7, 9, 23			
21tr	0515	WJTC	44 FL		410	
		0708	Valley 7 (bars), 9, 17 (ID bars), 23			
		1228	WDFX	34 AL	Ozark; Fox	481
			WJTC	44 FL		410
		1243	WJSP	28 GA	Columbus; GPTV	512
		1250	WTEV	47 FL	Jacksonville; UPN	728
		1253	WDHN	18 AL	Dothan	498
		1305	WJSU	40 AL	Anniston; 33/40	468
			Montgomery	AL 20, 32	436	
		1315	WFXL	31 GA	Albany	565
		1320	WTLH	49 GA	Bainbridge	551
			Birmingham	10, 13, 42	410	
		1335	WJEB	59 FL	Jacksonville; TBN	728
22tr	0308	Valley 7, 9, 23, 44				
		0600	Birmingham	10, 13, 42	410	
		0608	WCIQ	7 AL	Mt Cheaha; APT ID	469
		0620	WJSU	40 AL	Anniston	468
		0622	WTJP	60 AL	Gadsden; TBN	461
24tr	1100	WJTC	44 FL	Pensacola	410	
		1155	XERV	9 TA	Reynosa; weak	513
		1200	Montgomery	AL 20, 32	436	
		1235	Panama City	FL 28, 56	502	

1245	Tampa-St Petersburg	FL 28, 44, 50	740		
1254	WBSF	43 FL	Melbourne	840	
	WTGL	52 FL	Cocoa	841	
1305	WTXL	27 FL	Tallahassee	577	
1315	W26BB	26 MS	Vicksburg	166	
27tr	1420	Valley 4, 5, 7, 9, 17, 23			
	Es	2203	unID	2 SS to SE	
28Es	0105	unID	2	CBS to NW	
tr	1253	Valley 9, 17, 23			
Es	1910	unID	2	"Rosie" to NE	
	2205	WPBT	2 FL	Miami	939
			Cuba	2, 5	
	2220	unIDs	2, 4, 5	XEW, Azteca 7, others	
29Es	0220	KNAZ	2 AZ	Flagstaff	1045

COMMENTS: April was one of my all-time best months for tropo. Although April did not match the super tropo of May 1998, two new tropo records were set for me:
 (1) Most-distant-tropo within the US states: WFLX-29 West Palm Beach FL @ 912 miles.
 (2) Most 24-hour-periods with 700 mile tropo within the US states in one month: 3.
 The city of Veracruz is roughly the same distance as West Palm Beach and has been seen several times by tropo. The Veracruz stations have also been received via tropo three times in one month (May 1998).

Fernando Garcia, San Salvador 415, Rincon de la Sierra, Cd Guadalupe, NL, 67181 MEXICO
 ac001984@acnet.net,

FTD is furthest tropo of the day.
 TSLD is total stations logged for the day

Equipment: Sony KV-27EXR15, Screened CM 7'dish 85', RG11, UA900 amp. Sony KV-13TR27, CM 1110 30', CM 8' bay UHF array 60'. 1800' ASL,

No re-logs in the same month, only tropo 500+ miles.

March 1				
0000	WSCV	51 FL	Fort Lauderdale	1242
	WAMI	69 FL	Hollywood	1242
	WBFS	33 FL	Miami	1242
	WBZL	39 FL	Miami	1243
	WTTA	38 FL	St. Petersburg	1116
	WBHS	50 FL	Tampa	1116
	WTVK	46 FL	Naples	1153
	WFLX	29 FL	West Palm Beach	1238
0015	WXEL	42 FL	West Palm Beach	1238
	WHFT	45 FL	Miami	1244
	KADN	15 LA	Lafayette	586
	WPMI	15 AL	Mobile	838
	WFTS	28 FL	Tampa	1116
	WWWB	32 FL	Lakeland	1135
0030	KLPB	24 LA	Lafayette	567
	WLTW	23 FL	Miami	1242
	WZVN	26 FL	Naples	1153
	WPXM	35 FL	Miami	1237

Western TV DX F. Garcia's report continues

	W58BU	58 FL	Hallandale	w/WJTV-6	1243
	WLAE	32 LA	New Orleans		694
0300	KLTL	18 LA	Lake Charles		548
	WFGX	35 FL	Fort Walton Beach		892
	WLPB	27 LA	Baton Rouge		638
	WPAN	53 FL	Fort Walton Beach		869
	WUPL	54 LA	Slidell		705
0315	WGNO	26 LA	New Orleans		694
	WPXL	49 LA	New Orleans		688
0500	WVLA	33 LA	Baton Rouge		633
	KMSS	33 LA	Shreveport		615
	KETK	56 TX	Jacksonville		532
	KFKX	51 TX	Longview		557
0515	KLTS	24 LA	Shreveport		616
	K30EA	30 TX	Texarkana	TBN	651
	K65CE	65 LA	Shreveport	TBN	615
0530	KPJJ	21 LA	Minden		640
0600	WNOL	38 LA	New Orleans		694
	WMAH	19 MS	Biloxi		770
	WHNO	20 LA	New Orleans		688
	WEIQ	42 AL	Mobile		825
	WMPV	21 AL	Mobile		842
0615	K59DG	59 LA	New Orleans	TBN	688
0700	K30EM	30 LA	Houma		644
			HTV, loc. program.		
	WFTX	36 FL	Cape Coral		1142
			FL 1000+ miles is back, it was out six hours		
	K46DG	46 LA	Lafayette	UPN	587
	KLAF-LP	62 LA	Opelousas		600
	KVHP	29 LA	Lake Charles		530
0715	KAJN-LP	40 LA	Lafayette		586
			Family Vision		
	WMAU	17 MS	Bude		697
			Had to leave		
2130	WIMP-LP	25 FL	Miami	The BOX	1244
			Changed programming a week ago		
			Thanks for info. from Chris Dunne		
			ex-WFTDA member in Miami		
2145	WTEV	47 FL	Jacksonville		1179
	WAWS	30 FL	Jacksonville		1179
	WJEB	59 FL	Jacksonville		1180
	WFSG	56 FL	Panama City		929
	WDHN	18 AL	Dothan		982
2200	W29BH	29 MS	Biloxi	TBN	757
	WGFL	53 FL	High Springs		1112
	W46AV	46 MS	Pascagoula	TBN	783
	W69AY	69 FL	Alachua	TBN	1128
	WAWD	58 FL	Fort Walton Beach		897
	W50CF	50 AL	Mobile		817
			w/WPAN-53-VCC		
	W61DD	61 FL	Miami		1244
			SS mx videos		
2215	WJAN-LP	41 FL	Miami		1230
	W43AD	43 FL	Matecumbe	w/WSVN-7	1223
	W21AX	21 FL	Miami	Adv.	1237
2230	W59AJ	59 FL	Matecumbe		1223
			w/WPLG-10		
	W55BV	55 FL	Miami		1228
			SS, CBS Telenoticias		
	W64AN	64 FL	Rock Harbor		1239

2245	W56AZ	56 FL	Rock Harbor		1239
			with WTVJ-6		
			with WPBT-2		
	WFXL	31 GA	Albany		1066
	W41BN	41 AL	Dothan	TBN	980
	W36AC	36 MS	Mccomb	TBN	710
	WPGX	28 FL	Panama City		952
	WJSP	28 GA	Columbus		1057
			Both of the above chs 28 were over my local on same channel, a real mess.		
	WXXV	25 MS	Gulfport		764
	WSRE	23 FL	Pensacola		857
	WYES	12 LA	New Orleans		693
			over local, got it w/UHF dish		
2300	W68CM	68 FL	Panama City	TBN	943
	WTBC-LP	65 FL	Tallahassee	Worship	1025
	WIIQ	41 AL	Demopolis		877
2315	WTWC	40 FL	Tallahassee		1030
	WABW	14 GA	Pelham		1048
	WTXL	27 FL	Tallahassee		1031
	KWBJ-LP	39 LA	Morgan City	WB	618
2330	WJTC	44 FL	Pensacola		842
	W51CO	51 FL	Tallahassee	The BOX	1025
2345	WHBR	33 FL	Pensacola		838
	WPCT	46 FL	Panama City		934
			Tourism information		
March 2					
0000	K55HA	55 LA	New Iberia	UPN	596
	W47BP	47 MS	Hattiesburg	MS educ.	766
0015	WAFB	9 LA	Baton Rouge		638
			unid ch	57	The BOX
	WTLH	49 GA	Bainbridge		1029
	FTD		FL	Miami	1244
0215	WMAW	14 MS	Meridian		807
0230	K46CR	46 LA	Baton Rouge	The BOX	645
	K56DR	56 LA	Baton Rouge	TBN	633
	WCOV	20 AL	Montgomery		958
	W63BK	63 MS	Meridian	TBN	834
	KFAM-LP	65 LA	Crowley	w/KAJN-LP	572
	WDBD	40 MS	Jackson		754
	K69HD	69 LA	Church Point	UPN	586
0345	WGMB	44 LA	Baton Rouge		633
	WMCF	45 AL	Montgomery		965
	WIAT	42 AL	Birmingham		969
	WABM	68 AL	Birmingham		966
	KLFT-LP	21 LA	Lafayette	The BOX	592
	WHOA	32 AL	Montgomery		928
	WGIQ	43 AL	Louisville		987
0530	WGBC	30 MS	Meridian		834
	KDTC	58 TX	Dallas		518
	KFWD	52 TX	Fort Worth		522
	KHSX	49 TX	Irving		518
	KXTX	39 TX	Dallas		518
0545	WLTZ	38 GA	Columbus		1036
0615	WAIQ	26 AL	Montgomery		959
0630	WHTX	54 GA	Columbus		1037
			Had to leave		
March 4					
2145	FTD	50 FL	Tampa		1116
March 5					
0515	WMDN	24 MS	Meridian		834
0530	KAMC	28 TX	Lubbock		553

Western TV DX *F. Garcia's report continues*

0615	WGCU	30 FL	Fort Myers	1144
	WBBH	20 FL	Fort Myers	1144
0645	WOPX	56 FL	Melbourne	1189
	WTGL	52 FL	Cocoa	1200
0700	WXPX	66 FL	Bradenton	1115
	WBSF	43 FL	Melbourne	1200
0715	WMFE	24 FL	Orlando	1191
	WRBW	65 FL	Orlando	1192
	WKCF	18 FL	Clermont	1192
	WOFL	35 FL	Orlando	1191
	WUSF	16 FL	Tampa	1116

March 6

0615 unid ch 58 ss mx videos
San Antonio hdng lptv chs 20, 31, 52, 67 in

March 8

0615 FTD LA Lake Charles 530

March 9

2200 FTD LA Lafayette 586

March 11

0300 FTD TX Dallas 518

March 12

1830 FTD TX Dallas 518

March 13

0030 FTD LA Lafayette 586

March 16

2045 FTD FL Panama City 929

K3SES 35 TX McAllen PAX 130

2100 KLPA 25 LA Alexandria 619

KLAX 31 LA Alexandria 618

March 17

0130 KASN 38 AR Pine Bluff 772

KSHV 45 LA Shreveport 616

0145 KLRT 16 AR Little Rock 782

0200 WAPT 16 MS Jackson 754

0215 WLOX 13 MS Biloxi 762

WNTZ 48 MS Natchez 670

K67GL 67 LA Bunkie FOX 614

0230 K49DE 49 LA New Iberia TBN 596

WSWS 66 AL Opelika 1023

W52BC 52 AL Selma TBN 928

0245 K66FI 66 LA Opelousas 599

WPGA 58 GA Pery 1115

W45AA 45 MS Columbia MS educ. 739

WMPN 29 MS Jackson 747

0315 KYPX 42 AR Little Rock 803

KVTH 26 AR Hot Springs 739

WLMT 30 TN Memphis 901

WPXX 50 TN Memphis 904

0330 KVTN 25 AR Pine Bluff 783

KMCT 39 LA West Monroe 679

0345 WMAO 23 MS Greenwood 788

WLXT 15 MS Greenville 794

KLTM 13 LA Monroe 668

0430 FTD FL Jacksonville 1180

0500 WSST 55 GA Cordele 1081

WTJP 60 AL Gadsden 998

unid ch 30 The coin Club(CRN)

0515 WATL 36 GA Atlanta 1104

0600 WFIQ 36 AL Florence 964

WJSU 40 AL Anniston 992

0615	WETU-LP	39 AL	Wetumpka	969
	WTOK	11 MS	Meridian	834
	WTTO	21 AL	Homewood	969
	WAXC-LP	64 AL	Alexander city	995
0630	WUPA	69 GA	Atlanta	1100
	W51BY	51 AL	Birmingham TBN	966
0645	WHSG	63 GA	Monroe	1119
0700	K52EV	52 LA	Leesville FOX	574
	WCFT	33 AL	Tuscaloosa	924
	WMAV	18 MS	Oxford	866
0715	KTEJ	19 AR	Jonesboro	902
	KTVJ	48 AR	Jonesboro	896
	WGNX	46 GA	Atlanta	1104
	W47BS	47 AL	Talladega Rel., loc advs.	996

March 18

0645 FTD GA Columbus 1036

March 21

1030 FTD TX Dallas 518

March 22

0700 FTD LA New Orleans 694

March 23

0445 KPXD 68 TX Arlington 518

0530 FTD 56 FL Panama City 929

March 24

0545 FTD FL Fort Walton Beach 869

March 25

0630 FTD TX Dallas 518

March 27

08130 FTD TX Dallas 518

March 28

1300 FTD TX Dallas 518

March 31

0545 KAUT 43 OK Oklahoma City 706

0700 KSBI 52 OK Oklahoma City 692

KOKH 25 OK Oklahoma City 703

KOPX 62 OK Oklahoma City 705

1915 KDFI 27 TX Dallas 518

1930 KOZK 21 MO Springfield 906

1945 KTXA 21 TX Fort Worth 518

KSPR 33 MO Springfield 906

2000 KWHB 47 OK Tulsa 765

KWMJ 53 OK Tulsa 766

KXAS-DT141 TX Fort Worth

2100 KPOM 24 AR Fort Smith 783

This was a good month of March. This

beginning of the year is the best for 1000+ ever. I was

getting bored with no 600+ miles tropo for a week at

the end of the month, when it opened up to Springfield,

Missouri at the last hours of the month. It opened up

to Omaha, Nebraska on April 1st. morning. This

opening March 31-April 1st was helped by a warming

with temperatures with lows in the 50's and 60's up to

Nebraska.

April 1, 1999 CST/CDT

0100 KASN 38 AR Pine Bluff 772

KXTX 39 TX Dallas 518

KFWD 52 TX Fort Worth 522

KDTX 58 TX Dallas 518

0115 KETK 56 TX Jacksonville 532

KHSX 49 TX Irving 518

KDAF 33 TX Dallas 518

Western TV DX *F. Garcia's report continues*

	KTXA	21 TX	Fort Worth	518
	KAUT	43 OK	Oklahoma City	706
	KOPX	62 OK	Oklahoma City	705
	KJTL	18 TX	Wichita Falls	598
0230	KWHB	47 OK	Tulsa	765
	KPXD	68 TX	Arlington	518
	KLDT	55 TX	Lake Dallas	544
0245	KSBI	52 OK	Oklahoma City	692
	KFXK	51 TX	Longview	557
0430	KXVO	15 NE	Omaha	1094

	KTBO	14 OK	Oklahoma City	705
	KOKH	25 OK	Oklahoma City	703
	KSAS	24 KS	Wichita	853
	KWTV	9 OK	Oklahoma City	703
	KOCO	5 OK	Oklahoma City	704
0500	KXII	12 OK	Ardmore	614
	KPTM	42 NE	Omaha	1090
	K59DA	59 KS	Wichita TBN	850

0545	KTFO	41 OK	Tulsa	766
0600	KBZO-LP51	TX	Woodrow UNI	558
	KAMC	28 TX	Lubbock	553
0615	KWMJ	53 OK	Tulsa	766
	KOKI	23 OK	Tulsa	766
	KDOR	17 OK	Bartlesville	795

0630	KPTB	16 TX	Lubbock	555
0700	KADN	15 LA	Lafayette	586
	KDFI	27 TX	Dallas	518
1830	WLAE	32 LA	New Orleans	694
	WWLA	33 LA	Baton Rouge	633
	WLPB	27 LA	Baton Rouge	638
1900	KLPB	24 LA	Lafayette	567
2100	K69HD	69 LA	Church P. UPN	586

	K56DR	56 LA	Baton R. TBN	633
	WPAN	53 FL	Fort Walton B.	869
	WHNO	20 LA	New Orleans	688
2115	WXXV	25 MS	Gulfport	764
	WGNO	26 LA	New Orleans	694
	K30EM	30 LA	Houma loc.	644
2130	WNOL	38 LA	New Orleans	694
	KAJN-LP40	LA	Lafayette Rel.	586

	K46CR	46 LA	Baton R. BOX	645
	WPXL	49 LA	New Orleans	688
2145	WUPL	54 LA	Slidell	705
	K55HA	55 LA	New Iberia UPN	596
	WFSG	56 FL	Panama City	929
	WPMI	15 AL	Mobile	838
2200	WMAH	19 MS	Biloxi	770
	WMPV	21 AL	Mobile	842

	WGMB	44 LA	Baton Rouge	633
	K46DB	46 LA	Lafayette UPN	587
	K49DE	49 LA	New Iberia TBN	596

	April 2			
0200	KLAX	31 LA	Alexandria	618
	WDBD	40 MS	Jackson	754
	WAPT	16 MS	Jackson	754
0215	KXAS-DT141	TX	Fort Worth	
0230	KUVN-LP31	TX	Fort Worth UNI	521

	KMPX	29 TX	Decatur	537
	KLTL	18 LA	Lake Charles	548
0245	K47DK	47 OK	Grandfield	598

Shop at Home

0530	KCBQ	11 TX	Lubbock	555
	KLBK	13 TX	Lubbock	554
	K62DG	62 TX	Lubbock BOX	552
	KXTQ-LP46	TX	Lubbock	552
0600	K68EH	68 OK	Ponca C., calls	789
0715	K19DK	19 TX	Welch PTCB	519
2330	FTD	FL	Panama City	929
2345	K59DG	59 LA	N. Orleans TBN	688
	WMAW	14 MS	Meridian	807

TSLD:AL(2),FL(2),LA(25),MS(5),OK(10),TX(20)

April 3

0000	KLFT-LP21	LA	Lafayette UPN	592
	KVHP	29 LA	Lake Charles	530
	WGBC	30 MS	Meridian	834
0015	WMPN	29 MS	Jackson	747
0115	WIIQ	41 AL	Demopolis	877
	K51EC	51 LA	L. Charles TBN	532

2115	WTVK	46 FL	Naples	1153
	WZVN	26 FL	Naples	1153
2145	WFTX	36 FL	Cape Coral	1142
	WBBH	20 FL	Fort Myers	1144
2200	WRXY	49 FL	Tice	1142
	WGCU	30 FL	Fort Myers	1144
	WTTA	38 FL	St. Petersburg	1116
	WBHS	50 FL	Tampa	1116

TSLD:AL(2),FL(10),LA(13),MS(6)

April 4

2130 FTD LA Lafayette 586

TSLD:LA(2)

April 5

0245 KWBj-LP39 LA Morgan City WB 618

0330 WACX 55 FL Leesburg 1180

0415 K66FI 66 LA Opelousas TBN 599

0500 WMAU 17 MS Bude 697

0530 KLFY 10 LA Lafayette, o/loc 576

KFAM-LP65 LA Crowley 572

TSLD:FL(3),LA(26),MS(3),OK(1),TX(5)

April 6

0615 FTD LA Slidell 705

TSLD:LA(8)

April 7

0300 WFXL 31 GA Albany 1066

WHBR 33 FL Pensacola 838

WEIQ 42 AL Mobile 825

TSLD:AL(3),FL(3),GA(1),LA(14),MS(3),OK(5),TX(3)

April 8

0200 WLTX 38 GA Columbus 1036

WXTX 54 GA Columbus 1037

W41BN 41 AL Dothan TBN 980

WDHN 18 AL Dothan 982

W36AC 36 MS Mccomb TBN 710

0300 WGIQ 43 AL Louisville 987

WAWD 58 FL Fort Walton B. 897

0315 WSWG 66 AL Opelika 1023

0430 WPGA 58 GA Pery 1115

WPGX 28 FL Panama City 952

0445 W47BP 47 MS Hattiesburg 766

WMGT 41 GA Macon 1115

0530 WMCF 45 AL Montgomery 965

0545 WJSP 28 GA Columbus 1057

WDCO 29 GA Cochran 1125

Western TV DX *F. Garcia's report continues*

WMDN	24	MS	Meridian	834	
WHOA	32	AL	Montgomery	928	
WTWC	40	FL	Tallahassee	1030	
0600	WGNM	64	GA	Macon	1115
0615	KLPA	25	LA	Alexandria	619
0630	KPXJ	21	LA	Minden	640
	W63BK	63	MS	Meridian TBN	834
0700	WCOV	20	AL	Montgomery	958
	WABM	68	AL	Birmingham	966
	unid ch 59 NBC CDT				
0715	KLAF-LP62	LA	Opelousas UPN	600	
	K67GL	67	LA	Bunkie FOX48	614
0730	WSST	55	GA	Cordele	1081
	W52BC	52	AL	Salem TBN	928
2245	WGFL	53	FL	High Springs	1112
	WSRE	23	FL	Pensacola	857
2300	WJTC	44	FL	Pensacola	842
	W50CF	50	AL	Mobile VCC	817
	W52BF	52	AL	Mobile HSS	818
2315	WJEB	59	FL	Jacksonville	1180
	WTEV	47	FL	Jacksonville	1179
	WATL	36	GA	Atlanta	1104
	WUPA	69	GA	Atlanta	1100
	WHSJ	63	GA	Monroe	1119
	WSB-DT1 GA Atlanta				
2330	WPBA	30	GA	Atlanta	1103
	TSLD:AL(15),AR(1),FL(13),GA(13),LA(24),MS(12),TX(7)				
April 9					
0000	WOGX	51	FL	Ocala	1123
	W45AA	45	MS	Columbia MS ed	739
0245	WTJP	60	AL	Gadsden	998
	WIAT	42	AL	Birmingham	969
0300	WJSU	40	AL	Anniston	992
	WCFT	33	AL	Tuscaloosa	924
	WBSG	21	GA	Brunswick	1171
	WTTO	21	AL	Homewood	969
0330	WRBW	65	FL	Orlando	1192
	WWWB	32	FL	Lakeland	1135
	WOPX	56	FL	Melbourne	1189
	WTAT	24	SC	Charleston	1331
0400	WWMP	36	SC	Charleston	1320
0415	WLTX	19	SC	Columbia	1299
	WTGS	28	SC	Hardeeville	1222
0430	WYES	12	LA	New Orleans	693
	WWSB	40	FL	Sarasota	1108
0445	WFTS	28	FL	Tampa	1116
	WTGL	52	FL	Cocoa	1200
	WBSF	43	FL	Melbourne	1200
0500	WRJA	27	SC	Sumter	1320
	WBCC	68	FL	Cocoa	1200
	WUSF	16	FL	Tampa	1116
	WKCF	18	FL	Clermont	1192
0515	WFXB	43	SC	Myrtle Beach	1396
0530	WAWS	30	FL	Jacksonville	1179
	WTVT	13	FL	Tampa	1117
	WMFE	24	FL	Orlando	1191
0545	WABW	14	GA	Pelham	1048
0645	WVEA-LP61	FL	Tampa UNI	1104	
	W60BK	60	FL	Petersburg TBN	1093
0700	WCJB	20	FL	Gainesville	1121

W61AP	61	FL	Okeechobee WTOG-44	1201	
WTMO-LP40	FL	Kissimmee		1165	
SS CBS Telenovicias					
2045	WSCV	51	FL	Fort Lauderdale	1242
	WBZL	39	FL	Miami	1243
2100	WFLX	29	FL	West Palm Beach	1238
2130	WBFS	33	FL	Miami	1242
2145	W68CM	68	FL	Panama C. TBN	943
	WAMI	69	FL	Hollywood	1242
	WXEL	42	FL	West Palm Beach	1238
2200	WHFT	45	FL	Miami	1244
	WPXP	67	FL	Lake Worth	1248
	WFGC	61	FL	Palm Beach	1248
2215	W61DD	61	FL	Miami SS MX videos	1244
	WBSV	62	FL	Venice	1107
	WPXM	35	FL	Miami	1237
	WJXX	25	FL	Orange Park	1163
	WLOX	13	MS	Biloxi	762
2230	unid ch 24 CBS Telenovicias Houston hdn				
	logged several days				
	W24AT	24	FL	Sarasota TBN	1102
2245	W58BU	58	FL	Hallandale NBC6	1243
2300	WPXP	66	FL	Bradenton	1115
2330	WLTV	23	FL	Miami	1242
	TSLD:AL(15),FL(54),GA(10),LA(20),MS(9),SC(6),TX(2)				
April 10					
0000	WTOG	44	FL	St. Petersburg	1116
	W67BY	67	FL	Fort Myers TBN	1143
	W46AV	46	MS	Pascagoula TBN	783
0030	WUWB	17	FL	Jacksonville	1180
0130	WOFL	35	FL	Orlando	1191
	W65CE	65	LA	Shreveport TBN	615
	KLTS	24	LA	Shreveport	616
	FTD		FL	Lake Worth	1248
0330	WTXL	27	FL	Tallahassee	1031
0345	WTCE	21	FL	Fort Pierce	1231
0500	WPBF	25	FL	Tequesta	1228
	unid ch 55 w/WPBF-25				
0515	WTBC-LP65	FL	Tallahassee Rel	1025	
0745	WFLA	8	FL	Tampa	1116
	WAFB	9	LA	Baton Rouge	638
0800	WEDU	3	FL	Tampa	1116
0845	WPCT	46	FL	Panama City	934
	TSLD:AL(15),AR(1),FL(58),GA(4),LA(25),MS(8),TX(3)				
April 11					
0145	W31AU	31	FL	Orlando PAX	1169
	unid ch 26 Shop at Home Central FL hdn				
	WCEU	15	FL	New Smyrna B.	1191
	FTD		FL	Lake Worth	1248
0515	WVEN-LP63	FL	Orlando UNI	1171	
	W69AY	69	FL	Alachua TBN	1128
	TSLD:AL(1),FL(39),GA(2),LA(4),MS(1),TX(2)				
April 12					
0330	FTD		FL	Lakeland	1135
	TSLD:FL(4),LA(1)				
April 13					
2045	FTD		FL	Tampa	1116
	TSLD:AL(2),FL(3),LA(6),TX(1)				
April 14					
0430	W56CN	56	FL	Venice WB-32	1106
0530	FTD		FL	Miami	1244
0600	W29BH	29	MS	Biloxi TBN	757

Western TV DX *F. Garcia's report concludes*

TSLD:AL(3),FL(29),LA(9),MS(4)					
April 20					
0600	FTD		FL	Jacksonville	1180
2200	KARD	14	LA	West Monroe	659
	TSLD:AL(7),AR(1),FL(7),GA(3),LA(20),MS(9),TX(5)				
April 21					
0145	KMSS	33	LA	Shreveport	615
	KSHV	45	LA	Shreveport	616
0200	KYPX	42	AR	Little Rock	803
	KLRT	16	AR	Little Rock	782
0230	W36AJ	36	FL	Jacksonvi. HSS	1175
0445	WRAZ	50	NC	Raleigh	1444
0515	WELF	23	GA	Dalton	1091
	unid ch 22 (281)212-1037 pledge				
0530	WTOK	11	MS	Meridian	834
	WFGX	35	FL	Fort Walton B.	892
	WNTZ	48	MS	Natchez	670
	W51BY	51	AL	Birmingham TBN	966
0545	WBMA-LP58	AL	Birmingham ABC	963	
0615	WXVT	15	MS	Greenville	794
	WPXX	50	TN	Memphis	904
	WMAV	18	MS	Oxford	866
	WMAO	23	MS	Greenwood	788
	WLMT	30	TN	Memphis	901
0630	WFIQ	36	AL	Florence	964
0700	WZDX	54	AL	Huntsville	1025
	K61GO	61	LA	Hicks FOX 48	581
0715	WPGD	50	TN	Hendersonville	1102
0730	WHNT	19	AL	Huntsville	1028
	WAAY	31	AL	Huntsville	1028
2100	WTLH	49	GA	Bainbridge	1029
	TSLD:AL(22),AR(3),FL(36),GA(11),LA(32),MS(17),NC(1)OK(6),TN(3)TX(8)				
April 22					
0545	WGNX	46	GA	Atlanta	1104
0645	WTCI	45	TN	Chattanooga	1105
0700	WNEH	38	SC	Greenwood	1233
	WFLI	53	TN	Cleveland	1110
	WAXC-LP64	AL	Alexander c.loc 995		
	W52BJ	52	AL	Cullman loc	992
0715	unid ch 58 Belderly exercise				
	TSLD:AL(18),AR(1),FL(5),GA(9),LA(13),MS(8),OK(2),SC(2),TN(2),TX(5)				

April 23					
0100	W58BO	58	MS	Natchez TBN	670
	K45DI	45	LA	Mermentau TBN	599
2045	FTD		FL	Orlando	1192
	TSLD:AL(4),FL(24),GA(4),LA(27),MS(5),OK(3),TX(12)				
April 24					
0330	FTD		FL	Jacksonville	1180
0900	KLNM-LP42	TX	Lufkin A1	520	
	K30EA	30	TX	Texarkana FOX	651
	TSLD:AL(3),FL(16),GA(3),LA(22),MS(8),TX(7)				
April 25					
0230	FTD		FL	Orlando	1192
	TSLD:FL(7),LA(14),MS(3),TX(2)				
April 26					
0515	FTD		LA	Lafayette	586
	TSLD:LA(2),TX(2)				
April 27					
2100	FTD		LA	New Orleans	694
	K63EUT	63	TX	Corpus Christi	
	PTCB(GLC) also FTN, logged also on 28 and 29				
2215	unid ch 31 SS it seems to ID as SUR,				
	SNT hdn logged on three days				
	TSLD:LA(20),TX(4)				
April 28					
0100	WLFT-LP	52	LA	Baton Rouge	645
	Full audio ID, Family Net, video peaked to color.				
0145	FTD		AL	Mobile	842
0345	WSTY-LP	23	LA	Hammond	682
	Jewelry shop, (423)692-1345, thanks to J. Kruszka for help				
0615	K62FR	62	TX	New Braunfels	310
	April 1 Religious				
	TSLD:AL(3),LA(33),MS(5),TX(11)				
April 29					
0130	FTD		MS	Biloxi	770
	K68EI	68	TX	San Antonio	284
	GLC God's Learning Channel, thanks to P. Dyer for help				
	TSLD:LA(12),MS(1),TX(3)				
April 30					
2130	K15EZ	25	TX	Laredo PAX	133
	Best month of April ever and second best month after				
	May 98. Eight days in a row (Apr 7-14) to 1000+ miles. Total of 17 days to 1000+ miles.				
	73's				
	Fernando				

**W.T.F.D.A. -- THE CLUB
FOR FM & TV DX'ERS!!!**

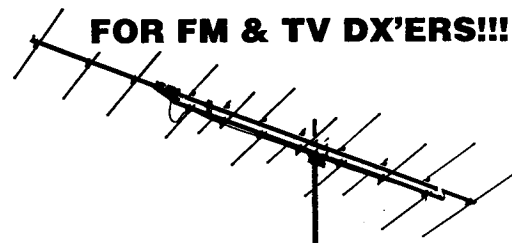

**Phase Cancellation Filters
For Suppressing:**

· Co-channel · In-Channel Carrier · Wideband Noise · Multipath · Adjacent TV/FM



2903 Series
The Phasing Principle:

When an undesired signal is received at the same frequency as the desired one, it is not possible to remove the interference with conventional filtering techniques without also destroying the desired signal. In this case, phase cancellation techniques are the solution.

The phasing method of interference suppression removes the interference without removing desired information transmitted at the same frequency. This is accomplished by matching the magnitude and inverting the phase 180°. The vector resultant is zero causing full cancellation of the undesired signal.

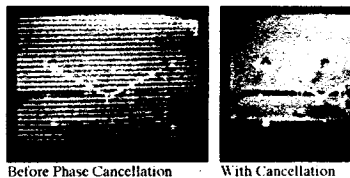
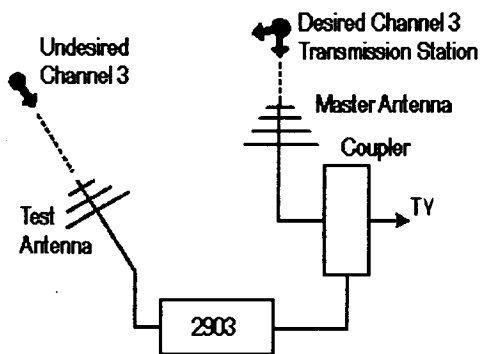
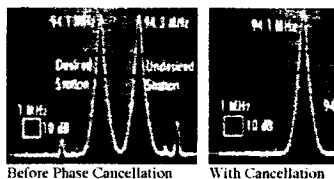
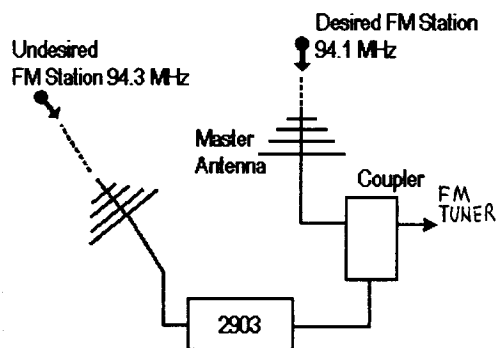

Co-Channel Reception

Co-Channel Reception is the most common application of the 2903 and occurs when the off air antenna receives two

**Your WTFDA Marketing Board
Introduces**

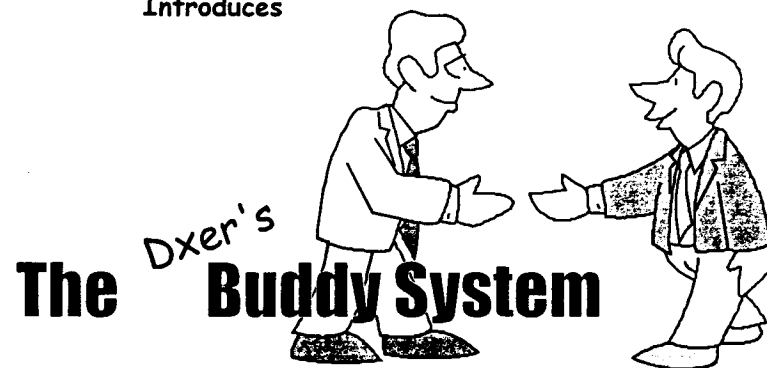

Now you can be a dxer's buddy, by sponsoring a TV/FM dxer that lives in a financially disadvantaged part of the world. Some people in second & third world countries that are TRUE dxers, are limited financially. By joining the Dxr's Buddy System, you can give your buddy a one year (or more) membership in the Worldwide TV/FM DX Association. Not only will it increase the joy of that persons interest in dxing, you'll also be spreading the word about TV/FM dxing to the world. And then there's the possibility of being named the Dxr's Buddy of the Year....

Your buddy also receives the VHF-UHF Digest for a full year (or longer), which can really make them feel like they belong to the WTFDA. They get on the road to learning even more about the hobby they love, where they can be in touch with other persons that like the same activity they do.

One day, someone might say to you, "Thanks for being my buddy!!"

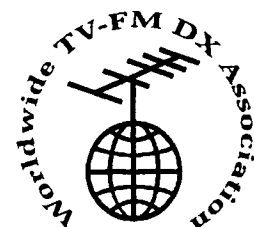
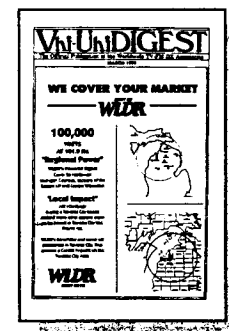

To get an instruction sheet and form for the Dxr's Buddy System, e-mail marketing team leader Jim Thomas at oldwest@oneimage.com, or, mail him at 280 E. Katsura Street, Milliken, CO 80543

If you'd like to know about someone you can sponsor, e-mail Mike Bugaj at ikon@netcom.com.

The world is waiting for YOU to be someone's buddy!!